

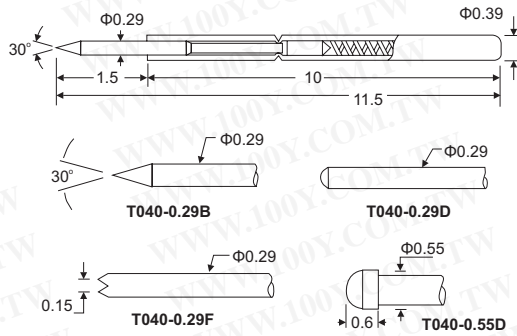

探針

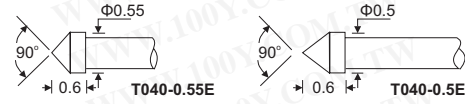

最小間距	0.75m/m
彈簧壓力	45g(2/3travel)
行程	1.5mm
鑽孔尺寸	0.57m/m
額定電流	0.5A
接觸電阻	50mΩ
材質	針軸：SK4鍍鈹 內管：白銅，鍍金 彈簧：琴鋼線，鍍金 套管：白銅，鍍金



Part No.	Product No.	製造廠商	說明	最小間距	鑽孔尺寸	行程	彈力	額定電流	接觸電阻	全長	尾端直徑
55327	R-040V(W)-700L		T-040 Contact Probe Series-套管+線(70cm)	0.75m/m	0.6m/m	1.5m/m	45gms	0.5A	50mohm	13mm	0.62mm
56516	T040-0.29B	T.C.P	探針	0.75m/m	0.57mm	1.5m/m	45gms	0.5A	50mohm	11.5	0.29
55328	T040-0.29D	T.C.P	T-040 Contact Probe Series-探針	0.75m/m	0.57mm	1.5m/m	45gms	0.5A	50mohm	11.5	0.29
56367	T040-0.29F	T.C.P	探針	0.75m/m	0.57mm	1.5m/m	45gms	0.5A	50mohm	11.5	0.29
56365	T040-0.55D	T.C.P	T-040 Contact Probe Series-探針	0.75m/m	0.57mm	1.5m/m	45gms	0.5A	50mohm	11.5	0.55
56364	T040-0.55E	T.C.P	T-040 Contact Probe Series-探針	0.75m/m	0.57mm	1.5m/m	45gms	0.5A	50mohm	11.5	0.55
17928	T040-0.5E	T.C.P	探針	0.75m/m	0.6m/m	1.5m/m	45gms	0.5A	50mohm	11.5	0.39

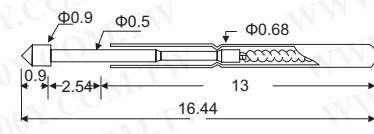

最小間距	1.27m/m
全壓彈力	30g, 60g, 80g, 120g
行程	2.54mm
鑽孔尺寸	0.9mm 0.95mm
額定電流	1.5A
接觸電阻	50mΩ
材質	PLUNGER: RH. PLATED SK4 BARREL: AU. PLATED PH. BRONZE

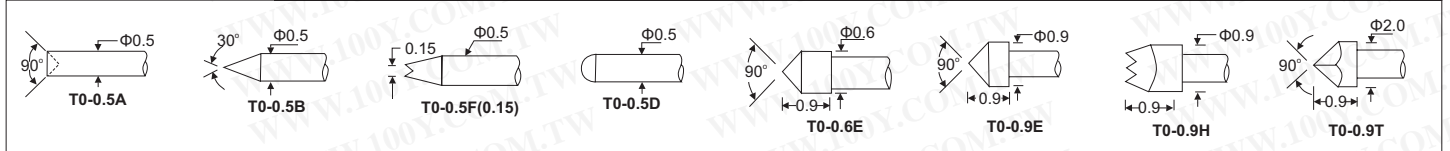
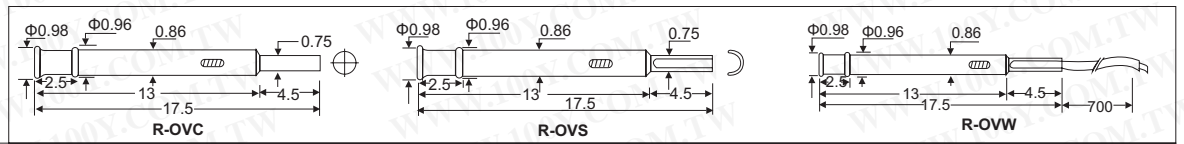
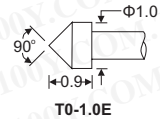

Part No.	Product No.	製造廠商	說明	最小間距	鑽孔尺寸	行程	彈力	額定電流	接觸電阻	全長	尾端直徑
34624	R-0V(W)-500L	T.C.P	長導腳, 端子及繞線柱-線(50cm)	-	-	-	-	-	-	-	-
58402	R-0V(W)-700L	T.C.P	長導腳, 端子及繞線柱-線(70cm)	1.27m/m	-	-	-	1.5A	70mΩ	-	0.98
54156	R-OVC	T.C.P	套管 for T-0 Bare Board Probes	-	0.9m/m, 0.95m/m	-	-	-	-	17.5	0.96
54505	R-OVS	T.C.P	套管 for T-0 Bare Board Probes	-	0.9m/m, 0.95m/m	-	-	-	-	17.5	0.96
10723	T0-0.5A-254	T.C.P	長導腳, 端子及繞線柱	1.27m/m	0.9m/m	2.54m/m	254gms	3A	50mlllohm	16.44mm	0.68
10722	T0-0.5B-254	T.C.P	探針	1.27m/m	0.9m/m	2.54m/m	254gms	3A	50mlllohm	16.44mm	0.68
12537	T0-0.5D-254	T.C.P	探針	1.27m/m	0.9m/m	2.54m/m	254gms	3A	50mlllohm	16.44	0.68
12538	T0-0.5F-0.15-254	T.C.P	探針	1.27m/m	0.9m/m	2.54m/m	254gms	3A	50mlllohm	16.44	0.68
12502	T0-0.6E-254	T.C.P	探針	1.27m/m	0.9m/m	2.54m/m	254gms	3A	50mlllohm	16.44mm	0.68
23762	T0-0.9E	T.C.P	長導腳, 端子及繞線柱	1.27m/m	0.9m/m	2.54m/m	128gms	3A	50mlllohm	16.44mm	0.68
12750	T0-0.9H-254	T.C.P	探針	1.27m/m	0.9m/m	2.54m/m	128gms	3A	50mlllohm	16.44mm	0.68
23763	T0-0.9T	T.C.P	長導腳, 端子及繞線柱	1.27m/m	0.9m/m	2.54m/m	128gms	3A	50mlllohm	16.44mm	0.68
12524	T0-1.0E-254	T.C.P	探針	1.27m/m	0.9m/m	2.54m/m	254gms	3A	50mlllohm	16.44mm	0.68

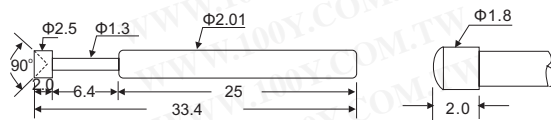

最小間距	3.17m/m
全壓彈力	200g, 300g
行程	6.4m/m
鑽孔尺寸	2.4m/m 2.45m/m
額定電流	5A
接觸電阻	50mΩ
材質	PLUNGER: RH. PLATED BE CU BARREL: AU. PLATED BRASS

Part No.	Product No.	說明	最小間距	鑽孔尺寸	行程	彈力	額定電流	接觸電阻	全長	尾端直徑	重量
52735	T9-1.8D-350	探針	3.17m/m	2.4; 2.45m/m	6.4m/m	350g	5A	50 mΩ	33.4mm	2.01	0.48g/pc

