

RELAYS & SOLENIIDS

PartNo.	ProductNo.	Manuf.	Description	ContactRating	Type	ContactArrangement	CoilVoltage	RecognizedSafety	OutlineLxWxH
14788	LY4NJ-AC220V	OMRON	Power 繼電器	10A/240VAC-10A/28VDC	LY4NJ	4PDT	200/220VAC	IEC255	40*26.5*35

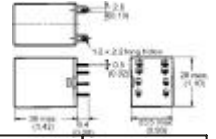

Increased reliability through automated production
 Multiple features available, including LED indicator, test button,
 bifurcated contacts, built-in diode and CR (surge suppression)
 Max. switching current: two-pole/10A, four-pole/5A
 Environment-friendly cadmium-free contacts
 Built-in operation indicator and nameplate is standard



PartNo.	ProductNo.	Manuf.	Description	ContactRating	Type	ContactArrangement	CoilVoltage	RecognizedSafety	OutlineLxWxH
17605	MY4N-24VDC	OMRON	小型有顯示燈 Power Relay	5A 250VAC/ 5 A30VDC	MY4N	4種	24Vdc	CSA,CE	36*28*21.5



Arc barrier equipped
 High dielectric strength (2,000VAC)
 Long dependable service life assured by AgCdO contacts
 Choose models with single or bifurcated contacts, LED indicator,
 diode surge suppression, push-to-test button, or RC circuit
 All models meet UL and CSA approvals; VDE, LR, and SEV approved versions are available

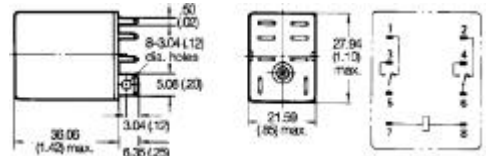

PartNo.	ProductNo.	Manuf.	Description	ContactRating	Type	ContactArrangement	CoilVoltage	RecognizedSafety	OutlineLxWxH
27589	LY2J-24VDC	OMRON	有指示燈 POWER 焊線式 繼電器	10A/110Vac	LY2J	2PDT	24Vdc	JL, CSA, SEV, LR, VDE	20.5*27*41.6
27591	LY2J-AC220V	OMRON	有指示燈 POWER 焊線式 繼電器	10A/110Vac	LY2J	2PDT	220Vac	JL, CSA, SEV, LR, VDE	20.5*27*41.6

IDEC-功率繼電器 IDEC Solder Power Relays

詳細產品規格--請點擊 www.100y.com.tw

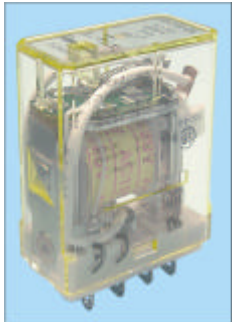

Key features of the RH series include:
 Compact midsize saves space
 High switching capacity (10A)
 Choice of blade or PCB style terminals
 Relay options include indicator light, check button, and top mounting bracket
 DIN rail, surface, panel, and PCB type sockets available for a wide range of mounting applications

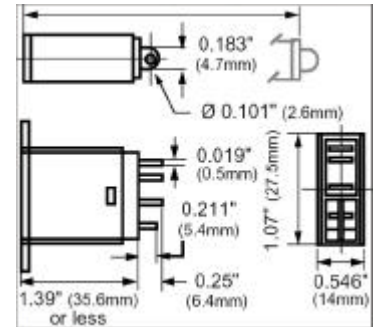

PartNo.	ProductNo.	Manuf.	Description	ContactRating	Type	ContactArrangement	CoilVoltage	RecognizedSafety	OutlineLxWxH
19780	RH1B-L-AC120V	idec	5脚 Power 繼電器	240VAC/10A,30VDC/10A	RH1B-L	SPDT	AC120V	UL, CE, SR, TUV	27*14*35mm

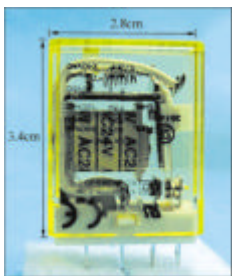

RH1B Series:
 Veris offers the IDEC RH1B Series, a SPDT blade-style socket relay for DIN rail mounting. All models are available in three coil voltage choices: 24VAC, 24VDC, or 120VAC, with contacts rated for 10A (resistive). RH1B-L models have the added benefit of a non-board status LED to provide local indication, especially useful during commissioning and troubleshooting. When used with SH1B-05 socket, these relays mount to standard DIN rails. A spring-loaded removal clip is included with each socket.

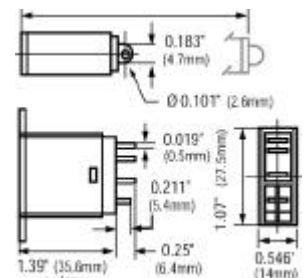

PartNo.	ProductNo.	Manuf.	Description	ContactRating	Type	ContactArrangement	CoilVoltage	RecognizedSafety	OutlineLxWxH
14131	RH1B-U-AC24V	idec	5脚 Power 繼電器	240VAC/10A,30VDC/10A	RH1B-U	SPDT	AC24V	UL, CE, SR, TUV	27*18*36mm

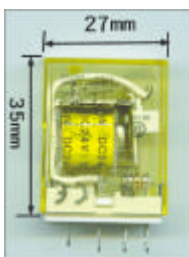

RH系列為大容量小形功率型繼電器，其接點容量10A，等效於RR系列繼電器。與和泉微型繼電器具有相同的外形尺寸。適合於緊湊型系統設計和小型控制設備安裝。

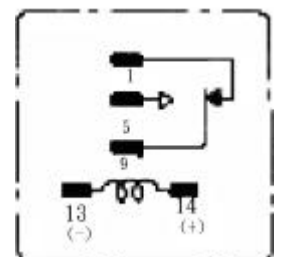

PartNo.	ProductNo.	Manuf.	Description	ContactRating	Type	ContactArrangement	CoilVoltage	RecognizedSafety	OutlineLxWxH
23557	RH1B-U-DC12V	idec	5脚 Power 繼電器	240VAC/10A,30VDC/10A	RH1B-U	SPDT	DC24V	UL, CE, SR, TUV	27*14*35mm
14292	RH1B-U-DC24V	idec	5脚 Power 繼電器	240VAC/10A,30VDC/10A	RH1B-U	SPDT	DC24V	UL, CE, SR, TUV	27*14*35mm

