

Battery Contact Kits ("AA")

AA (UM3)



G0311

30310-000(X1)+30320-000(X1)

勝特力材料 886-3-5753170
 勝特力电子(上海) 86-21-34970699
 勝特力电子(深圳) 86-755-83298787
[Http://www.100y.com.tw](http://www.100y.com.tw)

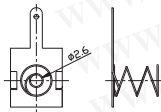
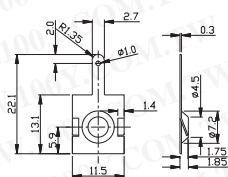

30310-000

30320-000

Part no.	Battery
G0311	AA (UM3) X 1
G0310	AA (UM3) X 2
G0313	AA (UM3) X 3
G0312	AA (UM3) X 4

G0310

30310-000(X1)+30320-000(X1)+30500-000(X1)

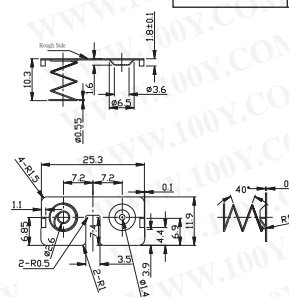
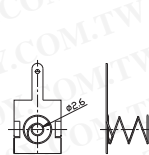
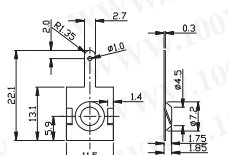

30310-000

30320-000

30500-000

● Example: G909G with G0310



G0313

30310-000(X1)+30320-000(X1)+30500-000(X1)+30500-040(X1)

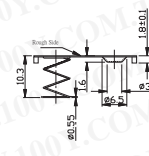
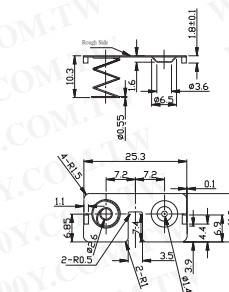
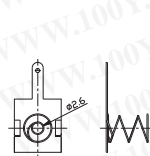
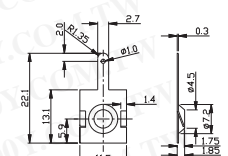

30310-000

30320-000

30500-000

30500-040

G0312

30310-000(X1)+30320-000(X1)+30500-000(X1)+30500-040(X2)

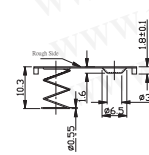
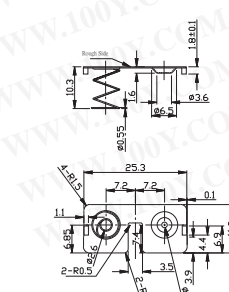
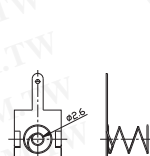
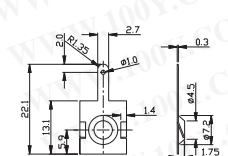

30310-000

30320-000

30500-000

30500-040

Battery Contact Kits ("AAA")

勝特力材料 886-3-5753170
 勝特力电子(上海) 86-21-34970699
 勝特力电子(深圳) 86-755-83298787
[Http://www.100y.com.tw](http://www.100y.com.tw)

AAA (UM4)



70978-000(X1)+70979-000

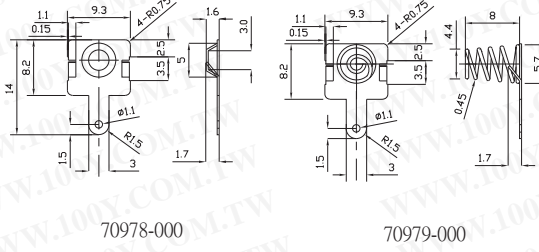

Part no.	Battery
G0411	AAA (UM4) X 1
G0410	AAA (UM4) X 2
G0413	AAA (UM4) X 3
G0412	AAA (UM4) X 4



70978-000(X1)+70979-000(X1)+70980-000(X1)

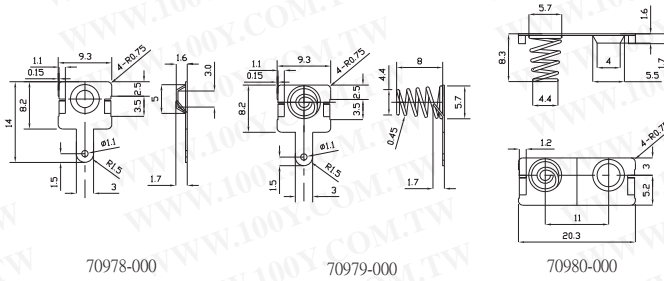

	Metal Parts	Spring
Material	SPTe (tin plate)	Steel
Finish	Tin plated	Nickel plated

● Example: G808B(BC) with G0412



70978-000(X1)+70979-000(X1)+70980-000(X1)+70980-040(X1)

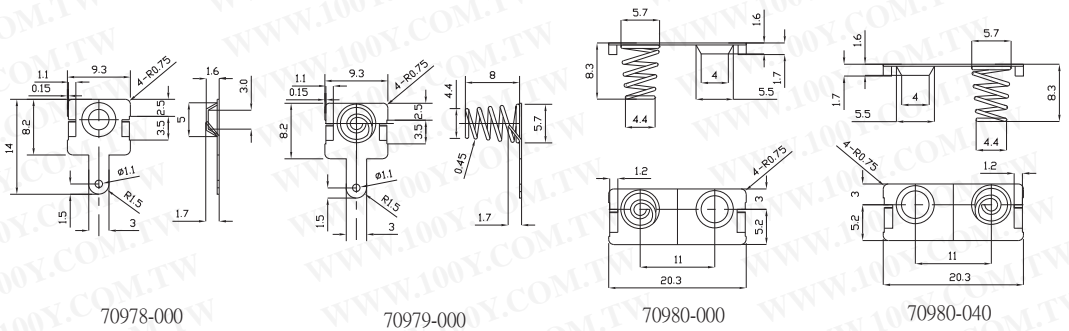

70978-000(X1)+70979-000(X1)+70980-000(X1)+70980-040(X2)

