

Manganese Dioxide Lithium Cylindrical Batteries: Individual Specifications

CR2

■ Dimensions(mm)

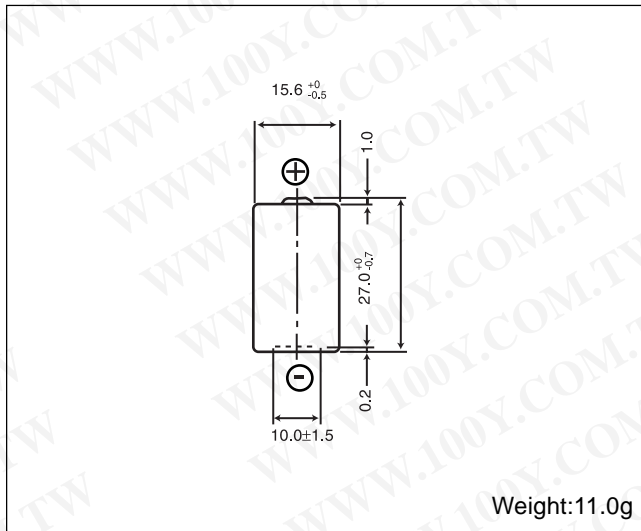

■ Specification

Nominal voltage (V)	3
Nominal capacity (mAh)	850
Continuous standard load (mA)	20
Operating temperature (C)	-40 ~ +70°

* Please consult Panasonic for use below and above -20°C to +60°C

■ Temperature Characteristics

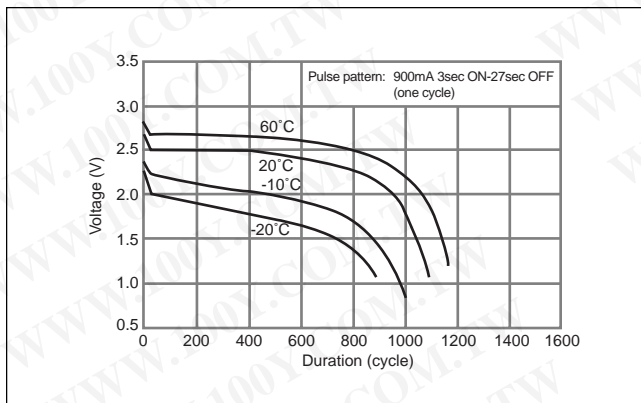

* Please consult Panasonic for use below and above -20°C to +60°C

CR123A

■ Dimensions(mm)

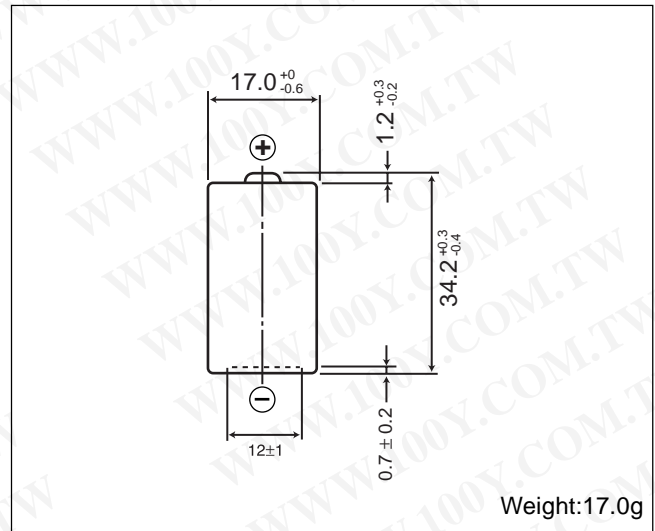

■ Specification

Nominal voltage (V)	3
Nominal capacity (mAh)	1,550
Continuous standard load (mA)	20
Operating temperature (C)	-40 ~ +70°

■ Temperature Characteristics

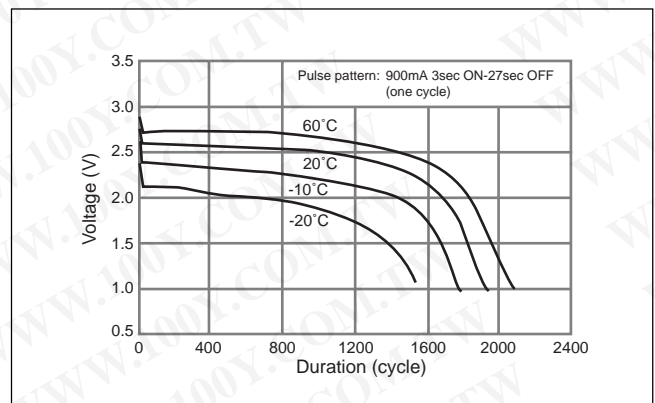

* Please consult Panasonic for use below and above -20°C to +60°C

勝特力材料 886-3-5753170
 勝特力电子(上海) 86-21-34970699
 勝特力电子(深圳) 86-755-83298787
[Http://www.100y.com.tw](http://www.100y.com.tw)