

## SALES PROGRAM AND TECHNICAL HANDBOOK

勝特力材料 886-3-5753170  
勝特力电子(上海) 86-21-34970699  
勝特力电子(深圳) 86-755-83298787  
[Http://www.100y.com.tw](http://www.100y.com.tw)



Rechargeable Button Cells  
NiMH

**勝特力材料 886-3-5753170**  
**勝特力电子(上海) 86-21-34970699**  
**勝特力电子(深圳) 86-755-83298787**  
**Http://www.100y.com.tw**

## CONTENT

1.	GENERAL INFORMATION	3-8
1.1	Product families	4-6
1.2	General Design and Application Criteria	7
2.	ASSORTMENT V...H(T) ROBUST (85)	9-24
2.1	Construction and Electrochemical Processes of NiMH High Rate Button Cells	10
2.2	Features V...H(T) Robust (85)	11
2.3	NiMH High Rate Button Cell Batteries for Bridging, Hot Swap and Memory Protection Applications	12
2.4	NiMH Button Cell Batteries for Memory Protection	13
2.5	NiMH Button Cell Batteries for Bridging Applications	14
2.6	Standard NiMH Button Cell Batteries for Alarm Equipment (Car Alarm, ...)	15
2.7	Standard NiMH Button Cell Batteries for Electronic Equipment	16-18
2.8	Charging Methods for NiMH Button Cells Robust Family	19-20
2.9	Recommended Charging Circuits	21
2.10	Charge Table for NiMH Button Cells	22
2.11	Discharge Characteristics of NiMH Button Cells	23
2.12	Discharge Diagram of NiMH Button Cells Robust Family	24
3.	ASSORTMENT V...HR(T) POWERFUL (85)	25-38
3.1	Construction and Electrochemical Processes of NiMH High Rate Button Cells	26
3.2	Features V...HR(T) Powerful (85)	27
3.3	NiMH High Rate Button Cell Batteries for Innovative IT and Automotive Applications	28
3.4	Examples of NiMH HIGH RATE Button Cell V...HR(T) Assemblies	29
3.5	Charging methods for Powerful Family	30-31
3.6	Charge Table for NiMH High Rate Button Cells V...HR(T)	32
3.7	Typical Charging Curves at Various Temperatures and Rates Robust (85)	33-34
3.8	Discharge Characteristics of NiMH High Rate Button Cells	35
3.9	Discharge Diagrams of NiMH High Rate Button Cells V...HR(T) Powerful Family	36-37
3.10	Permissible Temperature Range	38
4.	GENERAL CHARACTERISTICS	39-51
4.1	References	39
4.2	Reliability and Life Expectancy	40-41
4.3	Proper use and Handling	42-44
4.4	Transportation, Safety and Recycling Note for Batteries	45
4.5	Storage/Handling	46
4.6	Battery Assembly	47
4.7	Multicell Batteries	48
4.8	Definitions	49-50
4.9	Application Check List	51

# 1. GENERAL INFORMATION

勝特力材料 886-3-5753170  
勝特力电子(上海) 86-21-34970699  
勝特力电子(深圳) 86-755-83298787  
[Http://www.100y.com.tw](http://www.100y.com.tw)

VARTA Microbattery is a leading firm in the field of batteries and provides professional support for customers with engineered design-in applications worldwide. Quality, reliability, high performance and customer satisfaction are the main reasons for our leading position in the market. VARTA Microbattery provides solutions to major OEM companies for high-tech applications such as notebook/pda bridging function, memory backup and real-time clock in PCs/notebooks as well as power source for telecom devices, remote control devices, torches, domestic alarms, car alarms, medical equipment, consumer electronics, solar applications and many more.

## Key Features – Benefits

- Safety: built-in pressure vent guarantees safety in case of mistreatment
- Low self discharge: no handling, no charging – ready to use after storage due to superior self discharge performance
- Cycle Life: extended product life time of more than 1000 cycles (IEC)
- Overcharge capability: cost effective charging system with no need for special components due to patented GCE electrode
- Deep discharge capability: longer lasting shelf-life with high capacity retention after deep discharge
- No leakage: direct mounting on PCB possible due to patented crimp sealing system

## System highlights of NiMH Button Cells from VARTA Microbattery:

- Excellent high-rate discharge characteristics (3 CA/5 CA). For short duration even higher currents can be drained.
- No memory effect
- Long life – typical 500 full cycles
- Good overcharge capability
- Low self-discharge
- Flat discharge voltage
- Slim design
- Wide temperature range
  - Storage: -40°C up to +65°C/+85°C
  - Discharge: -20°C up to +65°C/+85°C
  - Charge: 0°C up to +65°C/+85°C
- Good recovery characteristics after long storage period and deep discharge
- 0% lead, 0% mercury and 0% cadmium
- UL Recognition
- ISO 9000 certified for design and manufacture of rechargeable mass type cells and batteries. Conformity to requirements of ISO 9001
- VARTA Microbattery is a leader of NiMH Button Cell technology and received several ecological and industry awards.

## Energy Density for Rechargeable Battery Systems

FIG. 1

Comparison of different rechargeable battery systems

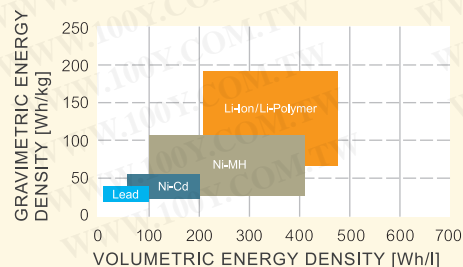

## 1.1 PRODUCT FAMILIES

勝特力材料 886-3-5753170  
 勝特力电子(上海) 86-21-34970699  
 勝特力电子(深圳) 86-755-83298787  
[Http://www.100y.com.tw](http://www.100y.com.tw)

Four button cell families with specific strengths and features provide the ideal battery solution for any application. Each family has its speciality to provide optimum solution for dedicated application areas.

### Product Overview

Type Designation	Type No.	Voltage (V)	Capacity (mAh)	Diameter (mm)	Height (mm)	Length (mm)	Width (mm)	Weight (g)
<b>V...H robust</b>								
V 15 H	55602	1.2	16	11.5	3.1			1.3
V 40 H	55604	1.2	43	11.5	5.35			1.7
V 80 H	55608	1.2	80	15.5	6.0			4.0
V 150 H	55615	1.2	150		5.85	14.1	25.6	6.0
V 200 H	55620	1.2	210		7.4	14.1	25.6	7.0
V 250 H	55625	1.2	250	25.1	6.7			10.0
CP 300 H	55630	1.2	300	25.1	7.55			11.0
V 350 H	55635	1.2	380	25.1	8.8			13.0
<b>V...HT robust85C</b>								
V 65 HT	55707	1.2	70	15.5	6.0			4.0
V 110 HT*	55711	1.2	120		5.85	14.1	25.6	6.0
V 150 HT	55715	1.2	150		5.85	14.1	25.6	6.0
<b>V...HR powerful</b>								
RTC 6	55997	1.2	7	6.8	2.15			0.28
V 6 HR	55996	1.2	6.2	6.8	2.15			0.28
MBU 20	55803	1.2	22	11.5	2.30			0.9
V 450 HR	55945	1.2	450		5.6	24.1	34.1	12.5
V 600 HR	55960	1.2	600		6.8	24.1	34.1	14.5
<b>V...HRT powerful85C</b>								
V 18 HRT	55802	1.2	19	11.5	2.3			0.9
V 500 HRT*	55850	1.2	510		6.6	24.2	34.1	14.0
V 500 H(R)T	55750	1.2	510		6.6	24.2	34.1	14.0
V 650 HRT	55865	1.2	650		6.8	24.2	34.1	15.0

TAB. 1

\* 0 to +65°C

## Capacity Range

From V 6 HR to V 650 HRT, from 6 mAh up to 650 mAh – VARTA provides a full programme of rechargeable button cells for all performance requirements.

## Quality – Made in Germany

- Manufactured on highly automated lines
- Direct replacement for NiCd
- No memory effect
- 0% lead, 0% mercury and 0% cadmium
- UL Recognition under file BBET2.MH13654

### V...H

robust

High performance button cell with superior overcharge stability and discharge currents  $\leq 2$  CA.  
Based on mass electrode technology, temperature range  $-20^{\circ}\text{C}$  to  $+65^{\circ}\text{C}$ .

Typical Applications:

- Memory Backup ■ Real Time Clock ■ Mobile Light

Type Designation	Type No.	Voltage (V)	Capacity (mAh)
V 15 H	55602	1.2	16
V 40 H	55604	1.2	43
V 80 H	55608	1.2	80
V 150 H	55615	1.2	150
V 200 H	55620	1.2	210
V 250 H	55625	1.2	250
CP 300 H	55630	1.2	300
V 350 H	55635	1.2	380

TAB. 2

**勝特力材料 886-3-5753170**  
**勝特力电子(上海) 86-21-34970699**  
**勝特力电子(深圳) 86-755-83298787**  
[Http://www.100y.com.tw](http://www.100y.com.tw)

### V...HT

robust85C

High performance button cell with superior overcharge stability and discharge currents  $\leq 2$  CA at high temperature.  
Based on mass electrode technology, temperature range  $-20^{\circ}\text{C}$  to  $+85^{\circ}\text{C}$ .

Typical Applications:

- Industrial Electronics ■ Automotive Applications

Type Designation	Type No.	Voltage (V)	Capacity (mAh)
V 65 HT	55707	1.2	70
V 110 HT*	55711	1.2	120
V 150 HT	55715	1.2	150

TAB. 3  
\* 0 to  $+65^{\circ}\text{C}$

**V...HR**  
powerful

High rate button cell with superior load capability for discharge currents up to 5 CA.  
Based on foam electrode technology, temperature range -20 to +65°C.

Typical Applications:

- Consumer Electronics ■ Health Care Devices
- Wireless Headsets, Headphones

Type Designation	Type No.	Voltage (V)	Capacity (mAh)
RTC 6	55997	1.2	7
V 6 HR	55996	1.2	6.2
MBU 20	55803	1.2	22
V 450 HR	55945	1.2	450
V 600 HR	55960	1.2	600

TAB. 4

**V...HRT**  
powerful85C

High rate and high temperature button cell with superior load capability for discharge currents up to 5 CA at high temperature.  
Based on foam electrode technology, temperature range -20 to +85°C.

Typical Applications:

- Automotive Electronics ■ Server, Computer
- Emergency Light, Solar Light

Type Designation	Type No.	Voltage (V)	Capacity (mAh)
V 18 HRT	55802	1.2	19
V 500 HRT*	55850	1.2	510
V 500 H(R)T	55750	1.2	510
V 650 HRT	55865	1.2	650

TAB. 5  
\* 0 to 65°C

勝特力材料 886-3-5753170  
 勝特力电子(上海) 86-21-34970699  
 勝特力电子(深圳) 86-755-83298787  
[Http://www.100y.com.tw](http://www.100y.com.tw)

**Battery Guide**

Four button cell families with specific strengths and features provide the ideal battery solution for any application.

	self discharge	over-charge	deep discharge	cycle life	storage behaviour	high rate capability	charge efficiency at high temp.	temperature range
V...H robust	++	++	++	+++	++	+	+	+
V...HT robust85C	++	+++	++	+++	++	+	++	++
V...HR powerful	+	+	+	+++	+	+++	+	+
V...HRT powerful85C	+	+	+	+++	+	++	++	++

TAB. 6

## 1.2 GENERAL DESIGN AND APPLICATION CRITERIA

The choice of the most suitable cells or battery types is exclusively related to the type of application and the operating conditions.

勝特力材料 886-3-5753170  
勝特力电子(上海) 86-21-34970699  
勝特力电子(深圳) 86-755-83298787  
[Http://www.100y.com.tw](http://www.100y.com.tw)

The most important criteria for selection are as follows:

- Type of operation of the cell, i.e. cyclic operation (continuous sequence of charge/discharge) or standby operation, trickle charged
- Available space
- Maximum weight
- Temperature during use
- Duration and level of load (continuous pulsed)
- Operating voltage required with voltage limiting values
- Charging conditions

The relevant cell data can be found in the corresponding sections of this catalogue. The data comprises standard values for planning purposes. As such they describe the performance for each cell type and always refer to single cells.

For the assembly of batteries we will assist you with all our long experience and expertise.

Standard battery assemblies up to 10 cells (12 V nominal voltage) are available.

Assemblies with higher numbers of cells are possible under certain application conditions. Ask us – we will advise you.

For further orientation and planning, please find a check list on page 51 of this handbook.

勝特力材料 886-3-5753170  
勝特力电子(上海) 86-21-34970699  
勝特力电子(深圳) 86-755-83298787  
[Http://www.100y.com.tw](http://www.100y.com.tw)



## 2. ASSORTMENT V...H(T) ROBUST (85)



勝特力材料 886-3-5753170  
勝特力电子(上海) 86-21-34970699  
勝特力电子(深圳) 86-755-83298787  
[Http://www.100y.com.tw](http://www.100y.com.tw)

勝特力材料 886-3-5753170  
 勝特力电子(上海) 86-21-34970699  
 勝特力电子(深圳) 86-755-83298787  
[Http://www.100y.com.tw](http://www.100y.com.tw)

## 2.1 CONSTRUCTION AND ELECTROCHEMICAL PROCESSES OF NIMH BUTTON CELLS

A special sealing design maximizes the diffusion path and guarantees optimal protection against leakage. The cup of the casing acts as the positive terminal and the lid as the negative terminal. The punched positive sign on the cell is used as a safety device which opens at predetermined internal pressure, in case of gross abuse. Some cells are interchangeable with 1.5 V primary cells of identical dimensions.

A sealed NiMH Button Cell requires that towards the end of the charging process, oxygen which is generated at the positive electrode must be consumed to avoid pressure build-up (charge reserve). Additionally a discharge reserve is necessary to prevent degradation of the negative electrode at the end of discharge. In general the negative electrode is overdimensioned compared with the positive, which determines the usable cell capacity (Fig. 2).

FIG. 2  
 Schematic view of a NiMH Button Cell

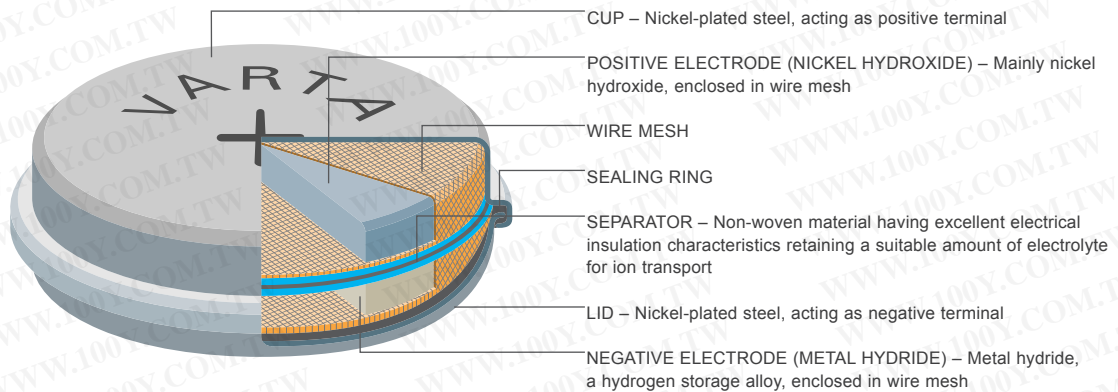

### Chemical Process of Charging/Discharging

$\text{Ni(OH)}_2 + \text{Metal}$	Charging	$\text{NiOOH} + \text{MH}$
	Discharging	
Charge product of the positive electrode:		Nickel (III) oxyhydroxide - NiOOH
Charge product of the negative electrode:		Metal hydride
Discharge product of the positive electrode:		Nickel (II) hydroxide - Ni(OH) <sub>2</sub>
Discharge product of the negative electrode:		Metal alloy
Electrolyte:		Alkaline solution (KOH)

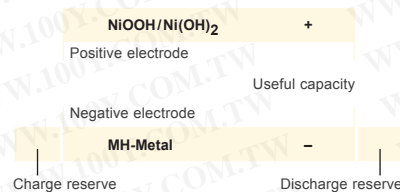

FIG. 3  
 Schematic representation of the electrodes, demonstrating useful capacity, charge reserve and discharge reserve

## 2.2 FEATURES V...H(T) ROBUST (85)

勝特力材料 886-3-5753170  
 勝特力电子(上海) 86-21-34970699  
 勝特力电子(深圳) 86-755-83298787  
[Http://www.100y.com.tw](http://www.100y.com.tw)

- Cells with typical capacities from 16 up to 380 mAh
- Nominal cell voltage 1.2 V
- Wide operating temperature range
- Built-in safety device
- UL Recognition
- Limited fast charge possible (within 3 h at 0.5 CA, at +20°C, after fully discharged cells)
- Suitable for overcharging at room temperature
- Long life expectancy
- Self-discharge less than 10% after 1 month at +20°C
- High temperature range V...HT
  - High capacity
  - Long life expectancy especially at charging/trickle charging and discharging at higher ambient temperature



Technical Data	V 15 H	V 40 H	V 80 H	V 150 H	V 200 H	V 250 H	CP 300 H	V 350 H	V 65 HT	V 110 HT	V 150 HT	
Order Number	55602 101 501	55604 101 501	55608 101 501	55615 101 501	55620 101 501	55625 101 501	55630 101 501	55635 101 501	55707 101 501	55711 101 501	55715 101 501	
Typ. Capacity (mAh)	16	43	80	150	210	250	300	380	70	120	150	
Nominal Voltage (V)	1.2	1.2	1.2	1.2	1.2	1.2	1.2	1.2	1.2	1.2	1.2	
Nom. Capacity (mAh)	15	40	70	140	200	240	280	350	65	110	140	
<b>Dimension</b>												
Diameter/Length (mm)	11.5 <sub>-0.1</sub>	11.5 <sub>-0.2</sub>	15.5 <sub>-0.1</sub>	25.6 <sub>-0.2</sub>	25.6 <sub>-0.15</sub>	25.1 <sub>-0.15</sub>	25.1 <sub>-0.15</sub>	25.1 <sub>-0.15</sub>	15.5 <sub>-0.2</sub>	25.6 <sub>-0.2</sub>	25.6 <sub>-0.2</sub>	
Height (mm)	3.1 <sub>-0.2</sub>	5.35 <sub>-0.3</sub>	6.0 <sub>-0.2</sub>	5.85 <sub>-0.25</sub>	7.4 <sub>-0.25</sub>	6.7 <sub>-0.6</sub>	7.55 <sub>-0.6</sub>	8.8 <sub>-0.6</sub>	6.0 <sub>-0.3</sub>	5.85 <sub>-0.25</sub>	5.85 <sub>-0.25</sub>	
Width (mm)	-	-	-	14.1 <sub>-0.2</sub>	14.1 <sub>-0.2</sub>	-	-	-	-	14.1 <sub>-0.2</sub>	14.1 <sub>-0.2</sub>	
Weight, approx. (g)	1.3	1.7	4	6	7	10	11	13	4	6	6	
<b>Charge Method</b>												
Normal Charging Current for 14-16 h (mA)	1.5	4	7	14	20	24	28	35	6.5	11	14	
Accelerated Charging for 7-8 h (mA)	3	8	14	28	40	48	56	70	13	22	28	
Limited Fast Charge <sup>1)</sup> for 3 h (mA)	7.5	20	35	70	-	120	140	-	32.5	55	70	
Trickle Charge (mA)	0.45	1.2	2.1	4.2	6.0	7.2	8.4	10.5	1.95	3.3	4.2	
<b>Overcharge Current at 20°C</b>												
For Continuous (mA)	1.5	4	7	14	20	24	28	35	6.5	11	14	
Max. 1 year (mA)	3.0	8	14	28	40	48	56	70	13	22	28	
Self-discharge (1 month storage, 20°C)	< 10%	< 10%	< 10%	< 10%	< 10%	< 10%	< 10%	< 10%	< 10%	< 10%	< 10%	
<b>Operating Temperature</b>												
Charging	0 to +65°C	0 to +65°C	0 to +65°C	0 to +65°C	0 to +65°C	0 to +65°C	0 to +65°C	0 to +65°C	0 to +85°C	0 to +65°C	0 to +85°C	
Discharging	-20 to +65°C	-20 to +65°C	-20 to +65°C	-20 to +65°C	-20 to +65°C	-20 to +65°C	-20 to +65°C	-20 to +65°C	-20 to +85°C	-20 to +65°C	-20 to +85°C	
Storage	-40 to +65°C	-40 to +65°C	-40 to +65°C	-40 to +65°C	-40 to +65°C	-40 to +65°C	-40 to +65°C	-40 to +65°C	-40 to +85°C	-40 to +65°C	-40 to +85°C	
<b>Life Expectancy (typical)</b>												
IEC Cycles	1000 cycles	1000 cycles	1000 cycles	1000 cycles	1000 cycles	1000 cycles	1000 cycles	1000 cycles	1000 cycles	1000 cycles	1000 cycles	
Trickle Charge at 20°C	up to 6 years	up to 6 years	up to 6 years	up to 6 years	up to 6 years	up to 6 years	up to 6 years	up to 6 years	up to 6 years	up to 6 years	up to 6 years	
Trickle Charge at 45°C	up to 3 years	up to 3 years	up to 3 years	up to 3 years	up to 3 years	up to 3 years	up to 3 years	up to 3 years	up to 5 years	up to 5 years	up to 5 years	
<b>Impedance/Internal Resistance<sup>2)</sup></b>												
Impedance (mOhm) <sup>3)</sup>	490	420	220	130	140	70	80	80	220	180	130	
Internal Resistance (Ohm) <sup>4)</sup>	4.03	3.05	1.30	0.8	0.8	0.46	0.47	0.47	1.25	1.00	0.8	

TAB. 7

<sup>1)</sup> After full discharge. Limited fast charge must be limited to room temperature, time controlled, voltage control recommended (except V 200 H, V 350 H).  
<sup>2)</sup> In accordance to IEC 61951-2, measured at charged cells at room temperature. Tolerance ±10%. <sup>3)</sup> AC at 1 kHz <sup>4)</sup> DC at 0.2 CA/2 CA

勝特力材料 886-3-5753170  
 勝特力电子(上海) 86-21-34970699  
 勝特力电子(深圳) 86-755-83298787  
[Http://www.100y.com.tw](http://www.100y.com.tw)

## 2.3 NIMH BUTTON CELL BATTERIES FOR BRIDGING, HOT SWAP AND MEMORY PROTECTION APPLICATIONS

### Bridging Batteries

Bridging batteries from VARTA Microbattery are optimised in small size and provide high power output for bridging mobile computers e.g. during main battery change. Bridging batteries temporarily take over the supply of DRAM and other chips in notebooks, PC's, palmtops, calculators, etc. when the main battery is replaced within a certain time frame specified by the manufacturer.

### Typical Application

- Mobile phones (GSM, PCN, GPRS, DECT, cordless phones)
- GPS-terminals/voice organizers

### Typical requirement

- Charging current: 0.03 CA continuous
- Discharge current: 30–100 mA<sup>1)</sup>
- Bridging time: 5–15 min.
- Operating temperature: 0 to +45°C

<sup>1)</sup> Proper selection of battery capacity is required.

### Mobile Computer Applications

Mobile computers need even more power. Frequent changing of main batteries should be made easy and convenient.

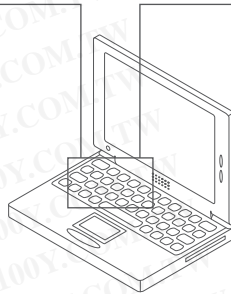
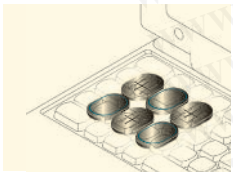

The VARTA HyRate "Hot Swap" batteries maintain the PC operational at high power levels during exchange of the main battery.



The VARTA HyRate "Bridging" batteries maintain the PC partially operational at reduced power levels during exchange of the main battery or during some periods of work interruption.

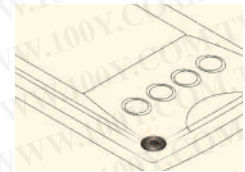

A single VARTA High Rate Cell is used in PDA/Pocket PC to maintain memory content during battery change.

### MBU/RTC Batteries

These batteries are designed for memory backup (MBU) and the support of RTC (Real Time Clock) in various electronic applications. Button cell batteries even in the charged state are suitable for wave soldering ( $t_{\max.} = 10 \text{ sec.}$ ,  $T_{\max.} = 265^\circ\text{C}$ ).

### Typical Application

- Mini Computing (Palm Top, PDA, ...)
- Notebooks
- VCR
- Car stereo, etc.

## 2.4 NIMH BUTTON CELL BATTERIES FOR MEMORY PROTECTION

### MBU/RTC Batteries

These batteries are designed for memory backup (MBU) and support to RTC (Real Time Clock) in various electronic applications. NiMH Button Cell Batteries in the charged state are suitable for wave soldering ( $t_{max.} = 10 \text{ sec.}$ ,  $T_{max.} = 265^{\circ}\text{C}$ ). For further information on other NiMH Button Cell Batteries for memory protection please consult VARTA Microbattery.

### Typical Application

- PCs
- Notebooks
- VCR
- Car stereo, etc.

Type	No. of cells	Order No.	Nominal voltage (V)	Typical capacity (mAh)	Nominal capacity (mAh)	Length (mm)	Width (mm)	Height without pins (mm)	Weight (g)
<b>Mempac S-H</b>									
3/V 15 H	3	55602 703 012	3.6	16	15	42.4 <sup>-0.6</sup>	17.0 <sup>-0.4</sup>	10.5 <sup>-1</sup>	7
1/V 150 H	1	55615 701 012	1.2	150	140	42.4 <sup>-0.6</sup>	17.0 <sup>-0.4</sup>	10.5 <sup>-1</sup>	9
2/V 150 H	2	55615 702 012	2.4	150	140	42.4 <sup>-0.6</sup>	17.0 <sup>-0.4</sup>	16.0 <sup>-1</sup>	15
3/V 150 H	3	55615 703 012	3.6	150	140	40.3 <sup>-0.6</sup>	22.2 <sup>-0.4</sup>	16.0 <sup>-1</sup>	21
3/V 150 H	3	55 603 940	3.6	150	140				
4/V 150 H	4	55 604 940	4.8	150	140				
5/V 150 H	5	55 605 940	6.0	150	140				
<b>Mempac Flat-H</b>									
2/V 80 H	2	55608 702 012	2.4	80	70	37.0 <sup>-0.3</sup>	20.0 <sup>-0.3</sup>	10.0 <sup>-1</sup>	10
3/V 80 H	3	55608 703 012	3.6	80	70	55.0 <sup>-0.3</sup>	20.0 <sup>-0.3</sup>	10.0 <sup>-1</sup>	15
<b>Popular Memory Backup Batteries for PC</b>									
3/V 15 H	3	55602 303 015 <sup>1)</sup>	3.6	16	15	10.6 <sup>-1</sup>	12.4 <sup>-0.5</sup>	12.4 <sup>-0.5</sup>	4
2/V 40 H	2	55604 302 059 <sup>2)</sup>	2.4	43	40	11.0 <sup>-1</sup>	12.0 <sup>-0.5</sup>	12.0 <sup>-0.5</sup>	6
3/V 40 H	3	55604 303 059 <sup>2)</sup>	3.6	43	40	16.8 <sup>-1.5</sup>	12.0 <sup>-0.5</sup>	12.0 <sup>-0.5</sup>	8
2/V 80 H	2	55608 303 012 <sup>1)</sup>	2.4	80	70	13.6 <sup>-2.2</sup>	16.0 <sup>-0.5</sup>	16.0 <sup>-0.5</sup>	10
3/V 80 H	3	55608 303 059 <sup>2)</sup>	3.6	80	70	19.0 <sup>-1</sup>	16.0 <sup>-0.5</sup>	16.0 <sup>-0.5</sup>	15

TAB. 8  
 Series Mempac S-H, Mempac Flat-H and other standard batteries (for temperature up to +65°C)  
<sup>1)</sup> Stack in shrink sleeve, with solder tags (2 pins)    <sup>2)</sup> Stack in shrink sleeve, with solder tags (3 pins)



2/V 40 H  
 (stack in plastic case)



3/V 40 H



3/V 80 H



Mempac Flat Series



Mempac Series

## 2.5 NIMH BUTTON CELL BATTERIES FOR BRIDGING APPLICATIONS

### Bridging Batteries

Bridging batteries from VARTA Microbattery are optimised in small size and provide high power output for bridging mobile computers e.g. during main battery change. Bridging batteries temporarily take over the supply of DRAM and other chips in notebooks, PCs, palmtops, calculators, etc. when the main battery is replaced within a certain time frame specified by the manufacturer.

**勝特力材料 886-3-5753170**  
**勝特力电子(上海) 86-21-34970699**  
**勝特力电子(深圳) 86-755-83298787**  
**Http://www.100y.com.tw**

### Typical Application

- Notebooks
- Palmtops
- Calculators

A typical requirement for example is this:

- Charging current: 0.1 CA (+0.03 CA) continuous
- Discharge current: 30–100 mA<sup>1)</sup>
- Bridging time: 5–15 min.
- Operating temperature: 0 to +45°C

<sup>1)</sup> Proper selection of battery capacity is required.

Type	No. of cells	Order No.	Nominal voltage (V)	Typical capacity (mAh)	Nominal capacity (mAh)	Length (mm)	Width (mm)	Height without pins (mm)	Weight (g)	Wire length (mm)
<b>NiMH Batteries for Bridging Applications</b>										
6/V 15 H	6	55602 406 020 <sup>1)</sup>	7.2	16	15	72.0	14.5	4.5	10	30
6/V 40 H	6	55604 406 012 <sup>1)</sup>	7.2	43	40	70.5	14.0	7.0	12	65
6/V 80 H	6	55608 406 012 <sup>1)</sup>	7.2	80	70	94.0	17.0	8.0	26	60

TAB. 9

<sup>1)</sup> Layflat version with wires and connector. Other configurations available on request.

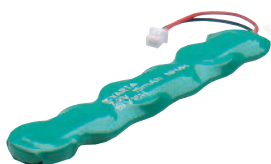

**6/V 15H**  
(layflat version)



**6/V 40H**  
(3x2 layflat version)



**6/V 80H**  
(3x2 stack up version)

## 2.6 STANDARD NIMH BUTTON CELL BATTERIES FOR ALARM EQUIPMENT (CAR ALARM, ...)

### Alarm Batteries

Reliable VARTA Microbattery Alarm Batteries with high capacity supply power for alarm signals as back up or main battery. VARTA Microbattery offers suitable solutions for all different alarm equipments (piezzo, electromagnetic loudspeakers, ...).

### Typical Application

- Car alarm equipment
- Domestic alarm equipment

Type	No. of cells	Order No.	Nominal voltage (V)	Typical capacity (mAh), 5 hours	Nominal capacity (mAh), 5 hours	Discharge current (mA), 0.2 CA	Charge current (mA), 14-16 hours	Dimensions (mm), l/b	Width (mm)	Height (mm)	Weight (g)
<b>NIMH Batteries for Alarm Equipment</b>											
6/V 150 H	6	55615 306 060	7.2	150	140	28	14	max. 26.5	15.0	max. 37.8	41
6/V 250 H	6	55625 306 060	7.2	250	240	48	24	25.8	-	40.7	65
6/V 250 H	6	55625 906 012	7.2	250	240	48	24	52.0	48.0	14.7	65
6/V 250 H	6	55625 906 014	7.2	250	240	48	24	52.0	48.0	14.7	65

TAB. 10 Further car alarm batteries in different configurations from 4.8 V up to 10.8 V are available. Please contact VARTA Microbattery.



6/V 150 H



6/V 250 H



6/V 250 H



6/V 250 H

FIG. 4 Discharge curve for car alarm application with a horn. Discharge of 6/V 250 H with 4 Ohm horn and typical discharge voltage and discharge current characteristics.

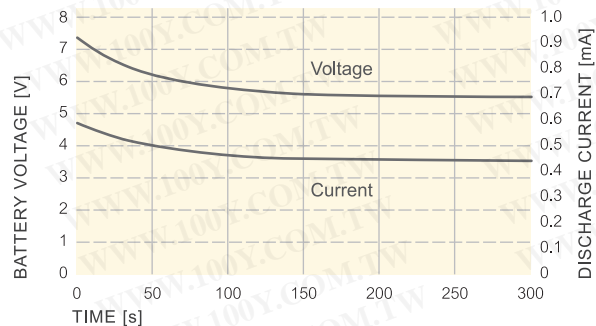

## 2.7 STANDARD NIMH BUTTON CELL BATTERIES FOR ELECTRONIC EQUIPMENT

The VARTA 9V Block is more than a Battery – it is the world's most consumer-friendly power pack. It is the only 9V block that combines the advantages of primary Alkaline batteries and traditional secondary NiMH

systems. With its unique modern button cell technology, the VARTA 9V battery vastly outperforms competition in everyday use.

### Consumer Friendly

- Very low self discharge and unmatched shelf life
- Only the VARTA 9V battery can be sold pre-charged and Ready 4 Use, without the need of initial charging
- Only the VARTA 9V battery will provide reliable power even if not used for months
- Can be re-charged more than 1000 times (IEC)

### Quality – Made in Germany

- Manufactured on highly automated lines
- Direct replacement for NiCd
- No memory effect
- 0% lead, 0% mercury and 0% cadmium
- UL recognition under file BBET2.MH13654

### Key Features

- Overcharge capability: cost-effective charging system without the need for special components, thanks to patented GCE electrode
- Deep discharge capability: longer shelf life with high capacity retention after deep discharge
- Safety: built-in pressure vent guarantees absolute safety in case of mistreatment
- Battery size is compatible with primary 9V-block battery and conforms with IEC 6F22, 6LR61.

### Typical Application

- Pocket radios
- Portable telephones
- Electronic calculators
- Cordless microphones
- Remote controls
- Medical instruments
- Scientific instruments
- Toys

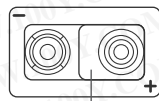

Contact plate<sup>1)</sup>

<sup>1)</sup> This contact plate is a feature to prevent charging primary 9V-block. We recommend this to be adopted at charger designs.



Type	No. of cells	Order No.	Nominal voltage (V)	Typical capacity (mAh), 5 hours	Nominal capacity (mAh), 5 hours	Discharge current (mA), 0.2 CA	Standard charge current (mA)	Charge duration (h)	Length max. (mm)	Width (mm)	Height (mm)	Weight (g)
<b>NiMH Batteries for Electronic Equipment</b>												
V 7/8 H R4Use	7	05122 101 501	8.4	180	170	34	17	14-16	48.5	26.6	15.7	48.0
V 6/8 H VARTA Accu Plus Ultra (US-version)	6	05422 106 052	7.2	150	140	28	14	14-16	48.5	26.6	15.7	41.0
V 7/8 H (EcoPack USA)	7	05522 726 501	8.4	150	140	28	14	14-16	48.5	26.6	15.7	47.0
V 7/8 H VARTA Accu Plus Ultra	7	05622 101 501	8.4	150	140	28	14	14-16	48.5	26.6	15.7	47.0

TAB. 11  
 Note: For further information see also V 150 H (page 11).

### Comparison of Cycle Stability: 150 mAh / 180 mAh Version

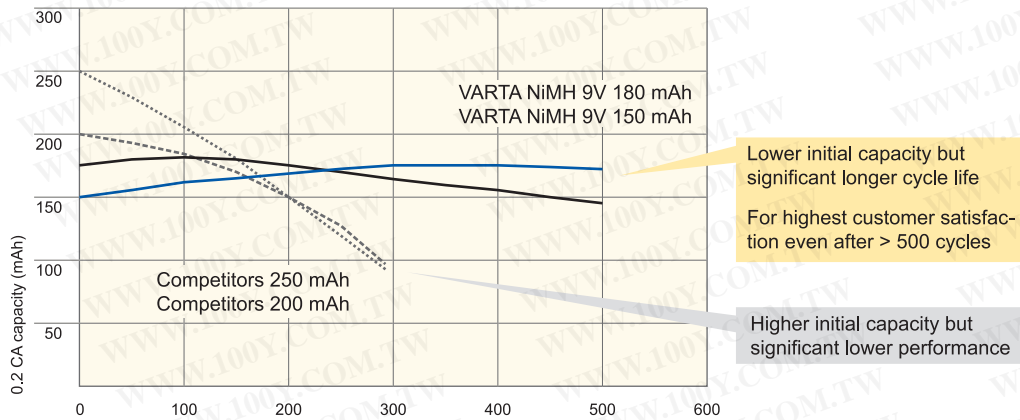

勝特力材料 886-3-5753170  
 勝特力电子(上海) 86-21-34970699  
 勝特力电子(深圳) 86-755-83298787  
[Http://www.100y.com.tw](http://www.100y.com.tw)

### Comparison of Self Discharge

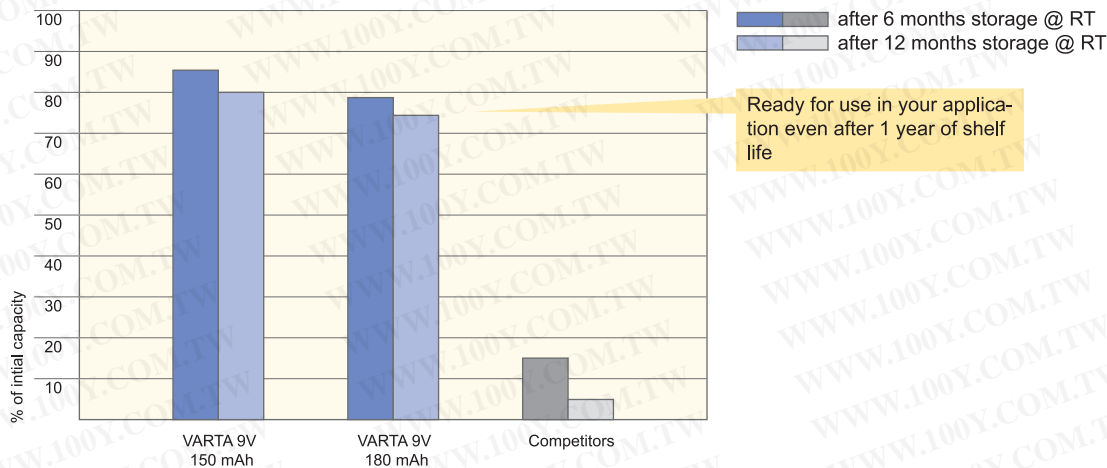

FIG. 5  
 Discharge characteristics of V7/8H

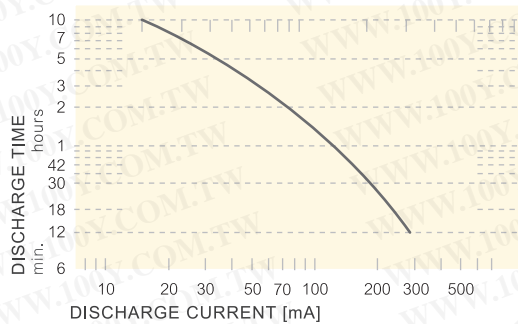
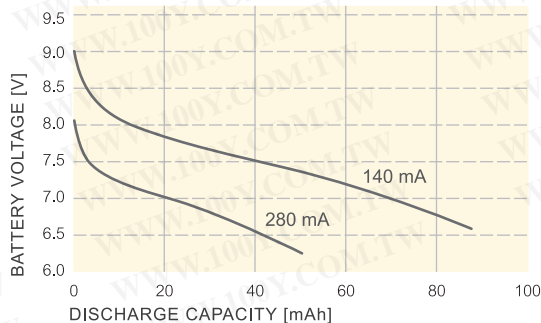

FIG. 6  
 Discharge curves of V7/8H



## 2.8 CHARGING METHODS FOR NIMH BUTTON CELLS ROBUST FAMILY

The most suitable method to fully charge sealed re-chargeable NiMH Button Cells is the constant current charge for a timed period.

### Standard Charge

Applicable for all NiMH Button Cell series. Charging is with constant current: 14–16 hours at 0.1 CA. Occasional overcharging at the nominal charge current (see page 11) is permissible. In special cases, a 24 hour charge at the nominal current is recommended, to achieve or restore the full performance of the cell or battery. This is a normal measure for:

- Initial charge to put into operation
- First recharge after prolonged storage
- Deep-discharged cells and batteries, particularly those which have been discharged into reverse unintentionally

### Accelerated charge

Accelerated charge means charging 7–8 hours at 0.2 CA. It is recommended that charging is controlled by means of a timer.

### Limited Fast Charge with Voltage Control<sup>1)</sup>

NiMH Button Cells can be fast charged with the charge rate, specified for each cell. Because of the specific charge current values this is called a limited fast charge (0.5 CA). It is possible to recharge more than 80% of the nominal capacity within 3 hours. Charging must be terminated after 3 hours. The cells must be fully discharged before charged with this method. Limited fast charge is recommended only at room temperature application.

<sup>1)</sup> Except V 200 H, V 350 H

勝特力材料 886-3-5753170  
勝特力电子(上海) 86-21-34970699  
勝特力电子(深圳) 86-755-83298787  
[Http://www.100y.com.tw](http://www.100y.com.tw)

### Trickle Charge

NiMH Button Cells are also suitable for trickle charging. A large number of applications need the use of cells or batteries which are kept at all times in a fully charged state to guarantee an emergency power supply or a standby operation.

To correctly specify a suitable constant charge current regime the following criteria apply:

- Maximum permissible trickle charge current (see page 11)
- Adjustment of the losses of capacity resulting from self-discharge
- Consideration of the charging efficiency as a function of the temperature and charge current
- Minimum recharge time from full discharge

To compensate the constant losses by self-discharge and to be able to recharge a discharged battery, for example due to a mains failure, a trickle charge current of 0.03 CA is recommended.

At this charge rate a life of up to 6 years (at room temperature) is to be expected. A reasonable reduction in life expectancy must be considered, when the battery will be overcharged at the maximum permitted over-charge current.

## Intermittent Trickle Charge

NiMH Button Cells can also be charged with this method. As the specified trickle charge is insufficient to fully charge a discharged battery at high temperatures and a constant overcharge at the specified rate or higher limits the life, a modified charging method can be adopted.

The following conditions must be observed:

- Charging of the discharged battery should take place time-controlled with a high rate possible, e.g. 0.2 CA, to recharge the battery quickly after a mains failure
- The following trickle charge should only cover the losses due to self-discharge and stabilise the available capacity

For this purpose a two-step charge is applied, one to fully charge the battery and a second for maintenance charging the battery. The first charge is terminated by a simple timer circuit.

After every discharge of the battery, regardless of the duration, a full charge is applied, e.g. charging for 7 to 8 hours at 0.2 CA. The trickle charge is however different from the previous methods and takes place at intervals. It is recommended that the intervals last at least 1 minute per hour and are at the accelerated charge rate, e.g. 0.1 to 0.2 CA.

In the interest of the life of the battery, however, no more than 10% of the nominal capacity should be recharged per day. This is sufficient to recover completely any losses due to self-discharge.

While the component cost for the electronic timing control is not excessive, the necessary transformer for full charge may not be available in every case.

Compromises are therefore necessary and may lead, for example, to the reduction of the charge rate in the full charge stage to 0.1 CA.

Note: Charging of cells connected in parallel must be avoided (if this cannot be avoided blocking by diodes is recommended).

勝特力材料 886-3-5753170  
勝特力电子(上海) 86-21-34970699  
勝特力电子(深圳) 86-755-83298787  
[Http://www.100y.com.tw](http://www.100y.com.tw)

## 2.9 RECOMMENDED CHARGING CIRCUITS

### Standard/Accelerated Charge

Charge circuit for charging cells/batteries at constant current at normal charge and accelerated charge. The charge process has to be interrupted by a timer at the end of the charging period.

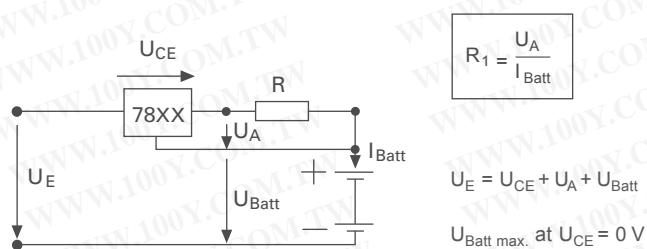

FIG. 7

勝特力材料 886-3-5753170  
 勝特力电子(上海) 86-21-34970699  
 勝特力电子(深圳) 86-755-83298787  
[Http://www.100y.com.tw](http://www.100y.com.tw)

### Trickle Charge

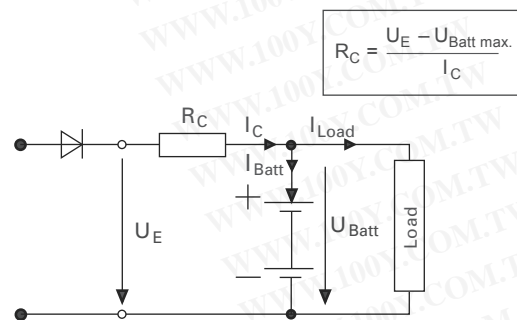

FIG. 8

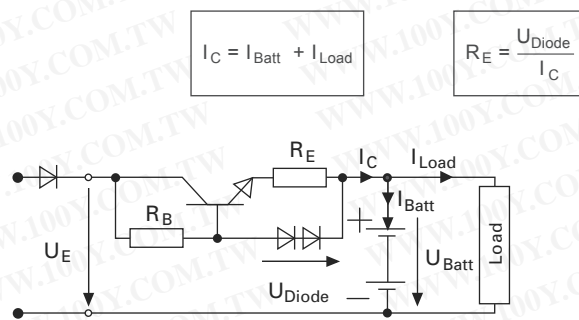

FIG. 9

## 2.10 CHARGE TABLE FOR NIMH BUTTON CELLS

### Charge Table

	Normal charge	Accelerated charge	Limited fast charge <sup>1)</sup>	Trickle charge	Max. possible overcharge capability <sup>2)</sup>
Specific currents	0.1 CA	0.2 CA	0.5 CA	0.01 CA to 0.03 CA	-
Charge time	14–16 hours	7–8 hours	3 hours	unlimited	-
Recommended charging values at room temp. for the robust family V...H(T)	0.1 CA 14–16 hours	0.2 CA 7–8 hours preferably time controlled	0.5 CA 3 hours time and voltage <sup>3)</sup> controlled	0.01 CA to 0.03 CA unlimited	0.1 CA for unlimited period at +20°C. 0.2 CA for max. 1 year at +20°C
Available capacity (%)	100	100	>80	100	>80

TAB. 12

<sup>1)</sup> Only at room temperature and after fully discharged cells, voltage control recommended (except V 200 H, V 350 H)

<sup>2)</sup> Reduction of life expectancy <sup>3)</sup> For specific cut off voltage ask VARTA Microbattery

Note: NiMH Button Cells shall not be charged at temperatures below 0°C

**勝特力材料 886-3-5753170**  
**勝特力电子(上海) 86-21-34970699**  
**勝特力电子(深圳) 86-755-83298787**  
**Http://www.100y.com.tw**

FIG. 10 TYPICAL TRICKLE CHARGING

Figure 10 shows battery voltage and charge current characteristics over charging time for a 2-cell battery in a typical trickle charge circuit

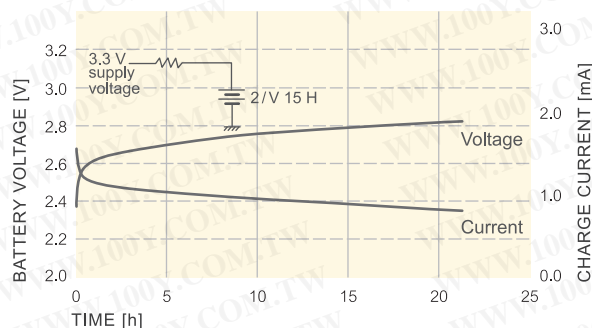

Recommended charging current 0.01 CA at room temperature

## 2.11 DISCHARGE CHARACTERISTICS OF NIMH BUTTON CELLS

The capacity and the voltage level of a cell during discharge are limited by various operational parameters. The most important of these are: the rate of discharge, the ambient temperature and the end of discharge

voltage. In general, the higher the discharge current, the lower the discharge voltage and the available capacity; this tendency becomes pronounced when the discharge current reaches 2 CA.

**FIG. 11**  
Discharge curves of NiMH Button Cells at various continuous loads

Typical discharge curves of NiMH Button Cells at +23°C

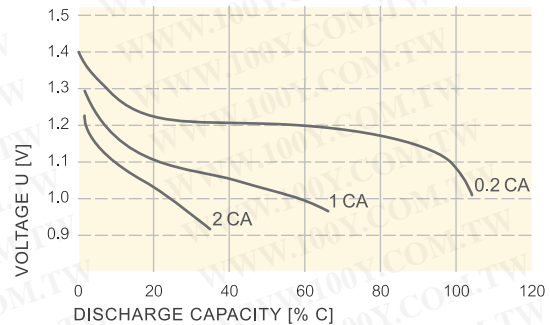

**FIG. 12**  
Discharge curves of NiMH Button Cells V...H(T) at various temperatures

A = -20°C  
B = 0°C  
C = +20°C  
D = +50°C  
E = +65°C

Charge: 0.1 CA for 16 hours at room temperature  
Discharge: 0.2 CA to 1 V at respective temperature

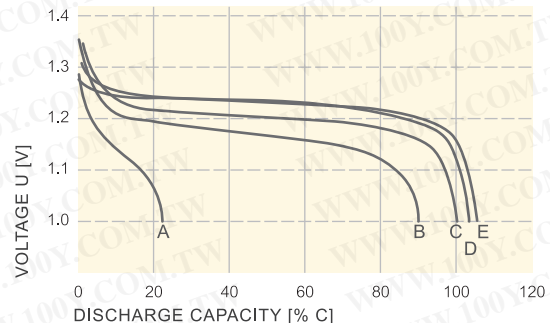

**FIG. 13**  
Relative capacities, based on the effective capacity (= 100% C at room temperature) as a function of the discharge temperature at 0.2 CA

Charge: 0.1 CA, 16 hours at room temperature  
Discharge: 0.2 CA to 1 V at various temperature

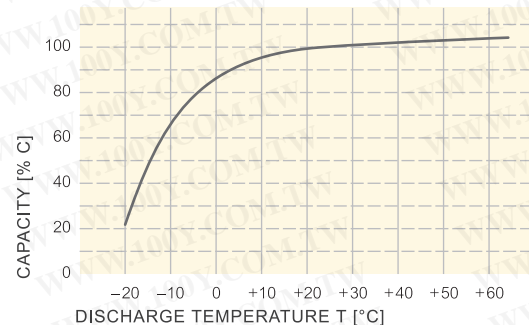

勝特力材料 886-3-5753170  
勝特力电子(上海) 86-21-34970699  
勝特力电子(深圳) 86-755-83298787  
[Http://www.100y.com.tw](http://www.100y.com.tw)

## 2.12 DISCHARGE DIAGRAM OF NIMH BUTTON CELLS ROBUST FAMILY

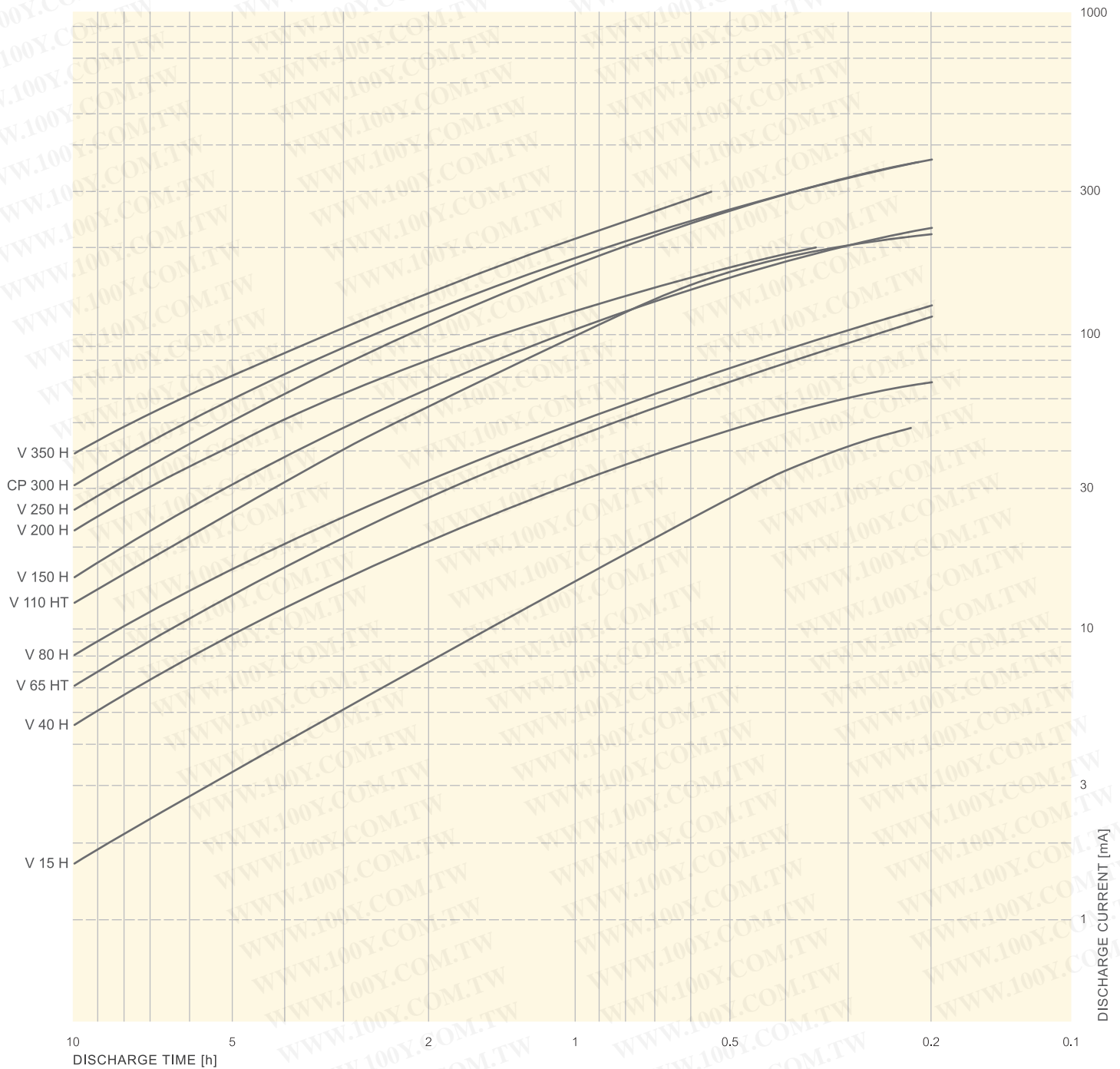

FIG. 14  
 Discharge diagram for selection of NiMH Button Cells Series V...H(T)  
 (T = +20°C, based on nominal capacity)



### 3. ASSORTMENT V...HR(T) POWERFUL (85)



勝特力材料 886-3-5753170  
勝特力电子(上海) 86-21-34970699  
勝特力电子(深圳) 86-755-83298787  
[Http://www.100y.com.tw](http://www.100y.com.tw)

### 3.1 CONSTRUCTION AND ELECTROCHEMICAL PROCESSES OF NIMH HIGH RATE BUTTON CELLS

A precision seal, with long diffusion path, ensures excellent sealing properties. The cup of the casing acts as the positive terminal and the lid as the negative terminal. The punched positive sign with precisely predefined rest-wall thickness on the cell serves as a safety device which opens smoothly at predetermined internal pressure, in case of gross abuse. The new Multi-Electrode technology is the reason for more power.

A sealed NiMH cell requires that towards the end of charging, oxygen which is generated at the positive electrode must be recombined to avoid pressure build-up. The extra charge-reserve capacity is responsible for this process. Additionally a discharge reserve is necessary to prevent degradation of the negative electrode at the end of discharge. In general the negative electrode is overdimensioned compared with the positive. The positive electrode determines the useable cell capacity (Fig. 16).

FIG. 15  
Schematic view of a NiMH High Rate Button Cell from VARTA Microbattery

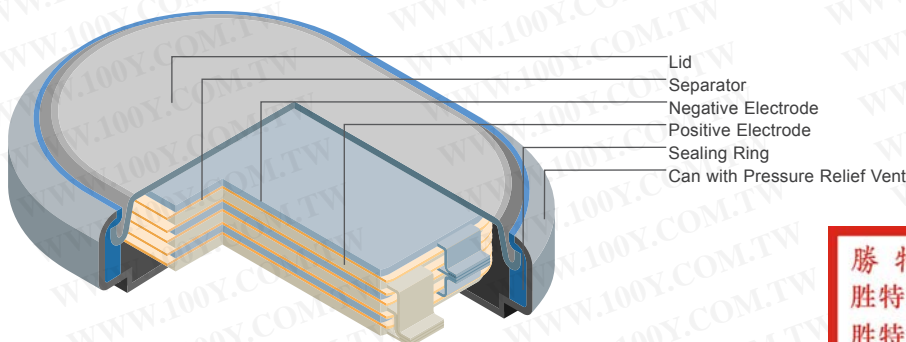

勝特力材料 886-3-5753170  
 勝特力电子(上海) 86-21-34970699  
 勝特力电子(深圳) 86-755-83298787  
[Http://www.100y.com.tw](http://www.100y.com.tw)

#### Chemical Process of Charging/Discharging

$Ni(OH)_2 + Metal$	Charging	$NiOOH + MH$
	Discharging	
Charge product of the positive electrode:		Nickel (III) oxyhydroxide – NiOOH
Charge product of the negative electrode:		Metal hydride
Discharge product of the positive electrode:		Nickel (II) hydroxide – $Ni(OH)_2$
Discharge product of the negative electrode:		Metal alloy
Electrolyte:		Alkaline solution (KOH)

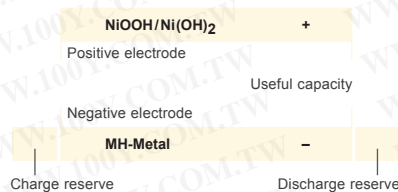

FIG. 16  
Schematic representation of the electrodes, demonstrating useful capacity, charge reserve and discharge reserve

### 3.2 FEATURES V...HR(T) POWERFUL (85)

- Cells with typical capacities from 3 up to 600 mAh
- Nominal cell voltage 1.2 V
- Wide operating temperature range
- Built-in safety device\*\*
- UL Recognition\*\*\*
- Fast charge capability (1 CA charge/-ΔV)\*
- Long life expectancy
- Self-discharge less than 20% after the 1st month at +20°C
- Excellent High Rate characteristics\* (3 CA/5 CA), short time even higher

\* multi-layer-electrode types  
 \*\* for cells with 7mm Ø or more  
 \*\*\* pending for V 3 HR, V 60 HR, V 120 HR



Technical Data	Single-layer-electrodes					Multi-layer-electrodes			
	V 6 HR	V 18 HRT	MBU 20	V 450 HR	V 500 H(R)T	V 500 HRT	V 600 HR	V 650 HRT	
<b>Type Number</b>	55996	55802	55803	55945	55750	55850	55960	55865	
Typical Capacity (mAh)	6.2	18	22	450	510	510	600	650	
Nominal Voltage (V)	1.2	1.2	1.2	1.2	1.2	1.2	1.2	1.2	
Nominal Capacity (mAh)	6	18	18	450	500	500	580	620	
<b>Dimension</b>									
Diameter/Length (mm)	6.8 -0.1	11.5 -0.1	11.5 -0.1	24.1 -0.2	24.2 -0.2	24.1 -0.2	24.1 -0.2	24.1 -0.2	
Height (mm)	2.15 -0.2	2.3 -0.3	2.4 -0.3	5.6 -0.3	6.5 -0.2	6.6 -0.5	6.8 -0.5	6.8 -0.4	
Width (mm)	-	-	-	34.1 -0.2	34.1 -0.2	34.1 -0.2	34.1 -0.2	34.1 -0.2	
Weight, approx. (g)	0.28	0.9	0.9	12.5	14.0	14.0	14.5	16.0	
<b>Charge Method</b>									
Normal Charging Current for 14-16 h (mA)	0.6	1.8	1.8	45	50	50	58	65	
Accelerated Charging <sup>1)</sup> for 4 h (mA)	3.0 (2.5h).	9.0 (2.5h)	9.0 (2.5h)	135	150	150	175	n.a.	
Fast Charge	n.a.	n.a.	n.a.	450	500	500	580	300	
Maximum Trickle Charge (mA)	0.18	0.6	0.6	13.5	15.0	5.0	17.5	6.5-19.5	
<b>Overcharge Current at 20°C</b>									
For Continuous (mA)	0.18	0.6	0.6	13.5	15	15	17.5	n.a.	
Max. 6 months (mA)	0.6	1.8	1.8	45	50	50	58	65	
Self-discharge (1 month storage, 20°C)	< 20%	< 20%	< 20%	< 20%	< 20%	< 20%	< 20%	< 20%	
<b>Operating Temperature</b>									
Charging	0 to +65°C	0 to +85°C	0 to +65°C	0 to +65°C	0 to +85°C	0 to +65°C	0 to +65°C	0 to +85°C	
Discharging	-20 to +65°C	-20 to +85°C	-20 to +65°C	-20 to +65°C	-20 to +85°C	-20 to +65°C	-20 to +65°C	-20 to +85°C	
Storage	-40 to +65°C	-40 to +85°C	-40 to +65°C	-40 to +65°C	-40 to +85°C	-40 to +65°C	-40 to +65°C	-40 to +85°C	
<b>Life Expectancy (typical)</b>									
IEC Cycles	1000 cycles	1000 cycles	1000 cycles	1000 cycles	1000 cycles	1000 cycles	1000 cycles	1000 cycles	
Trickle Charge at 20°C	~5 years	~5 years	~5 years	~5 years	~5 years	~5 years	~5 years	~5 years	
Trickle Charge at 45°C	-	~3 years	-	~2.5 years	~3 years	~3 years	-	~3 years	
<b>Impedance/Internal Resistance<sup>2)</sup></b>									
Impedance (Ω) <sup>3)</sup>	3.0	0.6	0.5	0.02	0.015	0.015	0.015	0.050	
Internal Resistance (Ω) <sup>4)</sup>	21	5	5	0.140	0.100	0.100	0.100	0.150	

TAB. 13

Type overview

<sup>1)</sup> After full discharge. Fast charge must be limited to room temperature, time controlled, voltage control recommended. <sup>2)</sup> In accordance to IEC 61951-2, measured at charged cells at room temperature. Tolerance ±10%. <sup>3)</sup> AC at 1 kHz <sup>4)</sup> DC at 0.2 CA/2 CA voltage differential method

\* not for new designs

### 3.3 NIMH HIGH RATE BUTTON CELL BATTERIES FOR INNOVATIVE IT AND AUTOMOTIVE APPLICATIONS

Higher demands for energy and the need for a wide temperature range make this NiMH High Rate Button Cell from VARTA Microbattery an ideal solution for IT and automotive applications. The slim design offers a vast flexibility for product designs. Depending on customer demands, a variety of battery

configurations are being made available. The wide temperature range of this cell allows the usage in applications where low or high temperature performance is a must. The cell is especially designed for high ambient temperatures, continuous up to 85°C.

FIG. 17  
Example:  
4/V 500 HRT

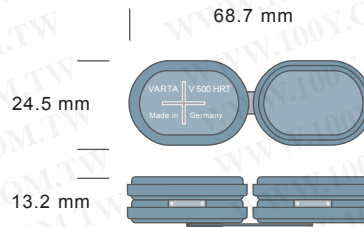

FIG. 18  
Typical discharge curves of NiMH High Rate Button Cell V 500 HRT at various temperatures

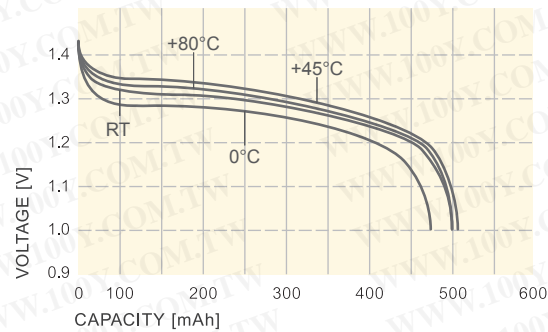
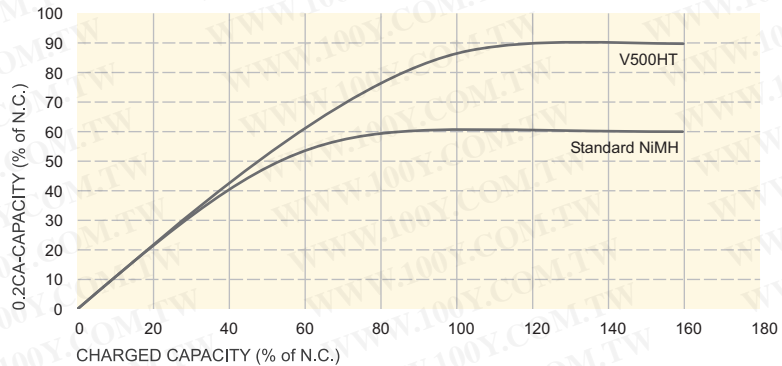

FIG. 19  
Charge efficiency for 0.6 CA charge @ 60°C



勝特力材料 886-3-5753170  
 勝特力电子(上海) 86-21-34970699  
 勝特力电子(深圳) 86-755-83298787  
[Http://www.100y.com.tw](http://www.100y.com.tw)

### 3.4 EXAMPLES OF NIMH HIGH RATE BUTTON CELL V...HR(T) ASSEMBLIES

The NiMH High Rate Button Cell generation from VARTA Microbattery is available in a various range of different cell assemblies, e.g.:

FIG. 20  
Example: 3/MBU 20



FIG. 21  
Example: 6/MBU 20



FIG. 22  
Example: 3/V 450 HR



FIG. 23  
Example: 4/V 450 HR



FIG. 24  
Example: 6/V 450 HR



FIG. 25  
Example: 3/V 450 HR



## 3.5 CHARGING METHODS FOR POWERFUL FAMILY

### CHARGING METHODS

#### 1. Standard Charge

The method to fully charge sealed NiMH cells is to charge at nominal constant current (0.1 CA) with time limited charge termination. The timer should be adjusted to terminate charging after having reached 150–160% capacity input (15–16 h) to avoid extended overcharge. This charging method may be used in the temperature range of 0 to +45°C. The cells should not be over-charged for more than 1000 hours at room temperature at a maximum rate of 0.1 CA.

#### 2. Accelerated Charge

An alternative method to fully charge NiMH cells in a shorter time is to charge at a constant current of 0.3 CA with time limited charge termination. The timer should be set to terminate charging after 4 hours, which is equivalent to 120% charge input. This charging method may be used in the temperature range of +10 to +45°C.

#### 3. Fast Charge

Another method to fully charge NiMH cells V450–V600 HR or batteries in an even shorter time is to charge at a constant current of 0.5–1 CA. Use of a timer control circuit alone is not sufficient for fast charge termination. In order to achieve the best cycle life we recommend the fast charge termination by  $dT/dt$ . For  $dT/dt$  control a temperature increase rate of 0.7°C/min should be used.

As shown in Fig. 26 the temperature rise as well as the voltage decrease can be used for charge termination.  $-\Delta V$ <sup>1)</sup> charge termination may be used.

Reference value for  $-\Delta V$  termination should be 5–10 mV/cell. An additional TCO<sup>2)</sup> device should be used to interrupt charging if these switch-off methods fail to respond. After the fast charge termination it is possible to switch to trickle charge at a rate of 0.01–0.03 CA.

#### 4. Trickle Charge

A large number of applications require the use of cells and batteries which are maintained in a fully charged condition. In order to compensate the loss of capacity due to self-discharge it is recommended to maintain a trickle charge current of between 0.01–0.03 CA. The preferred temperature range for trickle charge is in the range of +10 to +35°C. Trickle charge may be used following any of the previous charging methods.

<sup>1)</sup> For  $dT/dt$  and/or  $-\Delta V$  cut off applications please consult us for more detailed information. <sup>2)</sup> TCO = Temperature cut off.

FIG. 26  
 Charging characteristics  
 (Charging current > 0.5 CA)

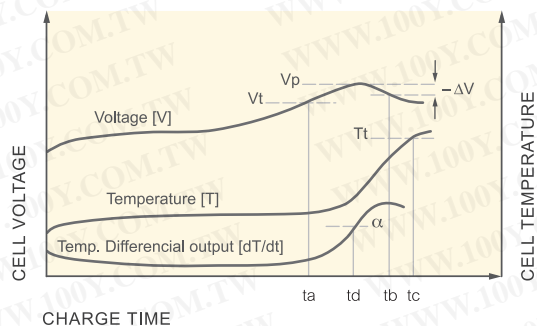

Charging recommended and methods refer to single cells. For batteries there may be different conditions requiring other means of charge or control.

## RECOMMENDED TEMPERATURE RANGE

### 1. Operating Temperature during Charge

Charge efficiency highly depends on operating temperature. Due to the increasing evolution of oxygen at the positive electrode charge efficiency decreases at higher temperatures.

At low temperatures charge efficiency is excellent. As the oxygen recombination process is slowed down at low temperature, a certain rise in internal cell pressure may occur depending on charge rate. Therefore the following ranges of operating temperatures are recommended.

- Standard charge: 0 to +45°C
- Accelerated charge: +10 to +45°C
- Fast charge: +10 to +45°C
- Trickle charge: +10 to +35°C

### 2. Operating Temperature during Discharge

The recommended temperature range is -20 to +60°C for discharge. Maximum capacity is obtained at an ambient temperature of about +24°C.

There is a slight decrease of capacity at higher temperatures and also at low temperatures. This reduction in capacity is more pronounced at low temperatures and high discharge rates.

### 3. Storage and Self-Discharge

The recommended temperature range for long-term storage is -20 to +35°C<sup>1)</sup>. Due to the self-discharge of the cells the stored capacity decreases over time. Self-discharge is dependent on temperature. The higher the temperature the greater the self-discharge over time. Long-term storage has no permanent effect on capacity, if recharging is done at least once a year. Please observe that batteries are faster discharged through leak-currents as soon as they are electrically connected with a device.

<sup>1)</sup> The relative humidity should be around 50%.

勝特力材料 886-3-5753170  
勝特力电子(上海) 86-21-34970699  
勝特力电子(深圳) 86-755-83298787  
[Http://www.100y.com.tw](http://www.100y.com.tw)

### 3.6 CHARGE TABLE FOR NIMH HIGH RATE BUTTON CELLS V...HR(T)

#### Charge Table

	Normal charge	Accelerated charge <sup>1)</sup>	Fast charge <sup>2)</sup>	Trickle charge
Specific currents	0.1 CA	0.3 CA	0.5–1 CA	0.01 CA to 0.03 CA
Charge time	14–16 hours	4 hours	1–2 hours	unlimited
Recommended charging values at room temperature for the powerful family V...HR(T)	0.1 CA 14–16 hours	0.3 CA 4 hours	0.5–1 CA	0.01 CA to 0.03 CA unlimited
Available capacity (%)	100	100	>80	100

TAB. 14

- <sup>1)</sup> Only at room temperature and after fully discharged cells, voltage control recommended (for multi-layer-electrodes)  
<sup>2)</sup> Special charge control is required (see p. 26)

Note: NiMH High Rate Button Cells shall not be charged at temperatures below 0°C

勝特力材料 886-3-5753170  
 勝特力电子(上海) 86-21-34970699  
 勝特力电子(深圳) 86-755-83298787  
[Http://www.100y.com.tw](http://www.100y.com.tw)

FIG. 27 TYPICAL TRICKLE CHARGING  
 Figure 27 shows battery voltage and charge current characteristics over charging time for a 2-cell battery in a typical trickle charge circuit

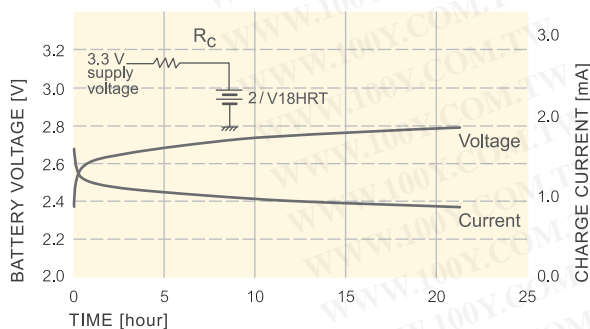

Trickle charge characteristics of e.g.  
 2/V 18 HRT  $R_C = 1 \text{ k}\Omega$



### 3.7 TYPICAL CHARGING CURVES AT VARIOUS TEMPERATURES AND RATES ROBUST (85)

FIG. 28  
Charging curves at various charging currents of NiMH Button Cells V...H(T) at +23°C

- A = 0.2 CA
- B = 0.1 CA
- C = 0.050 CA
- D = 0.033 CA
- E = 0.010 CA

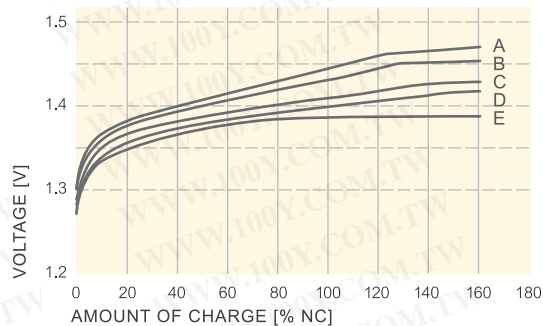

FIG. 29  
Charging curves at various charging currents of NiMH Button Cells V...H(T) at +45°C

- A = 0.1 CA
- B = 0.050 CA
- C = 0.033 CA
- D = 0.010 CA

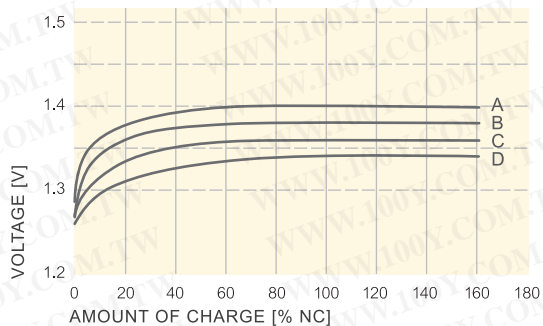
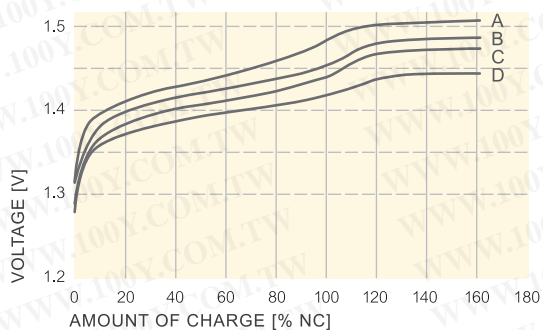

FIG. 30  
Charging curves at various charging currents of NiMH Button Cells V...H(T) at 0°C

- A = 0.1 CA
- B = 0.050 CA
- C = 0.033 CA
- D = 0.010 CA



勝特力材料 886-3-5753170  
 勝特力电子(上海) 86-21-34970699  
 勝特力电子(深圳) 86-755-83298787  
[Http://www.100y.com.tw](http://www.100y.com.tw)

## POWERFUL (85)

**FIG. 31**  
Typical charging curves at various charging currents of NiMH High Rate Button Cells V...HR at room temperature

A = 1 CA (ML)\*  
B = 0.3 CA (ML)\*  
C = 0.1 CA  
D = 0.03 CA

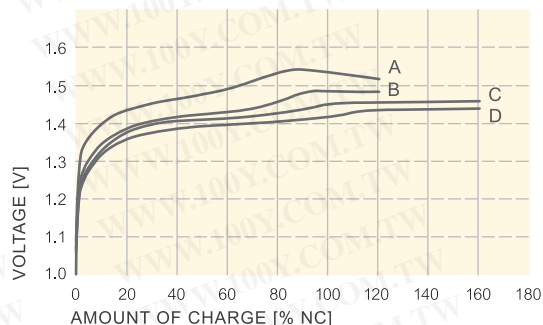

**FIG. 32**  
Charging curves at various charging currents of NiMH High Rate Button Cells V...HR at +45°C

A = 1 CA (ML)\*  
B = 0.3 CA (ML)\*  
C = 0.1 CA  
D = 0.03 CA

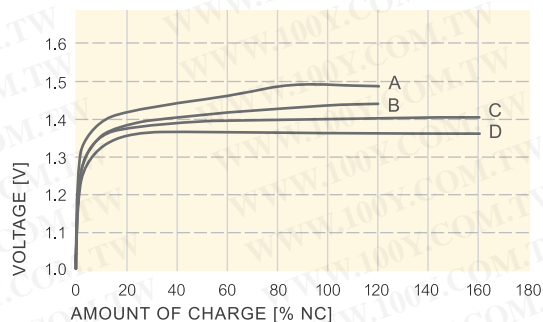

**FIG. 33**  
Charging curves at various charging currents of NiMH High Rate Button Cells V...HR at 0°C

A = 1 CA (ML)\*  
B = 0.3 CA (ML)\*  
C = 0.1 CA  
D = 0.03 CA

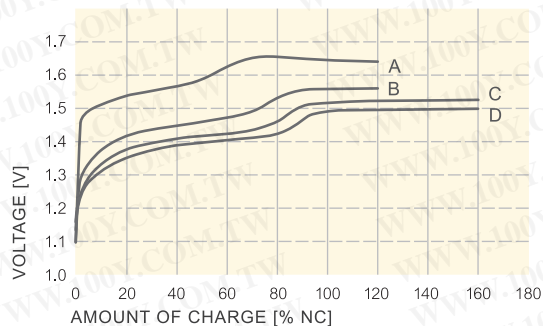

\* ML: Multi-Layer-Electrodes.  
i.e. V 450 HR, V 500 HRT, V 600 HR

勝特力材料 886-3-5753170  
勝特力电子(上海) 86-21-34970699  
勝特力电子(深圳) 86-755-83298787  
[Http://www.100y.com.tw](http://www.100y.com.tw)

### 3.8 DISCHARGE CHARACTERISTICS OF NIMH HIGH RATE BUTTON CELLS POWERFUL (85)

The capacity and the voltage level of a cell during discharge are limited by various operational parameters. The most important of these are: the rate of discharge, the ambient temperature and the end of discharge

voltage. In general, the higher the discharge current, the lower the discharge voltage and the available capacity; this tendency becomes pronounced when the discharge current reaches 5 CA.

**FIG. 34**  
 Typical temperature characteristics of NiMH High Rate Button Cells V...HR

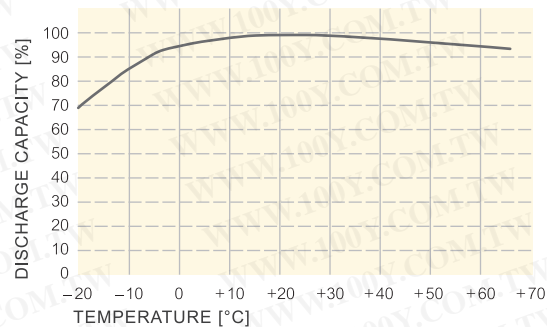

Discharge at 0.2 CA

**FIG. 35**  
 Typical discharge curves of NiMH High Rate Button Cells V...HRT Multi-layer-electrodes (ML) at room temperature

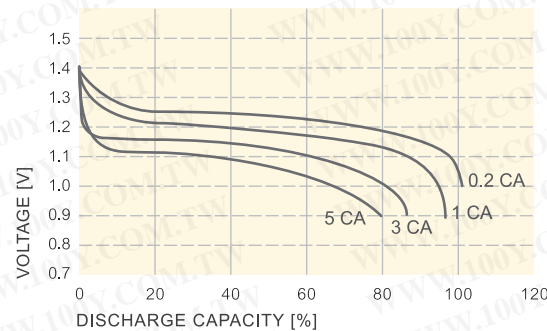

Discharge at various rates at 20°C

**FIG. 36**  
 Temperature characteristics of NiMH High Rate Button Cells V...HR Multi-layer-electrodes (ML) at GSM current profile

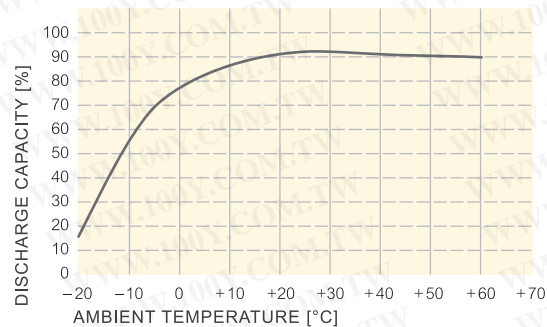

Charge: 0.1 CA at room temperature  
 Discharge: GSM-pulse  
 (1.8 A – 0.6 msec/0.2 A – 4 msec)  
 at various temperatures

勝特力材料 886-3-5753170  
 勝特力电子(上海) 86-21-34970699  
 勝特力电子(深圳) 86-755-83298787  
[Http://www.100y.com.tw](http://www.100y.com.tw)

### 3.9 DISCHARGE DIAGRAMS OF NIMH HIGH RATE BUTTON CELLS V...HR(T) POWERFUL FAMILY

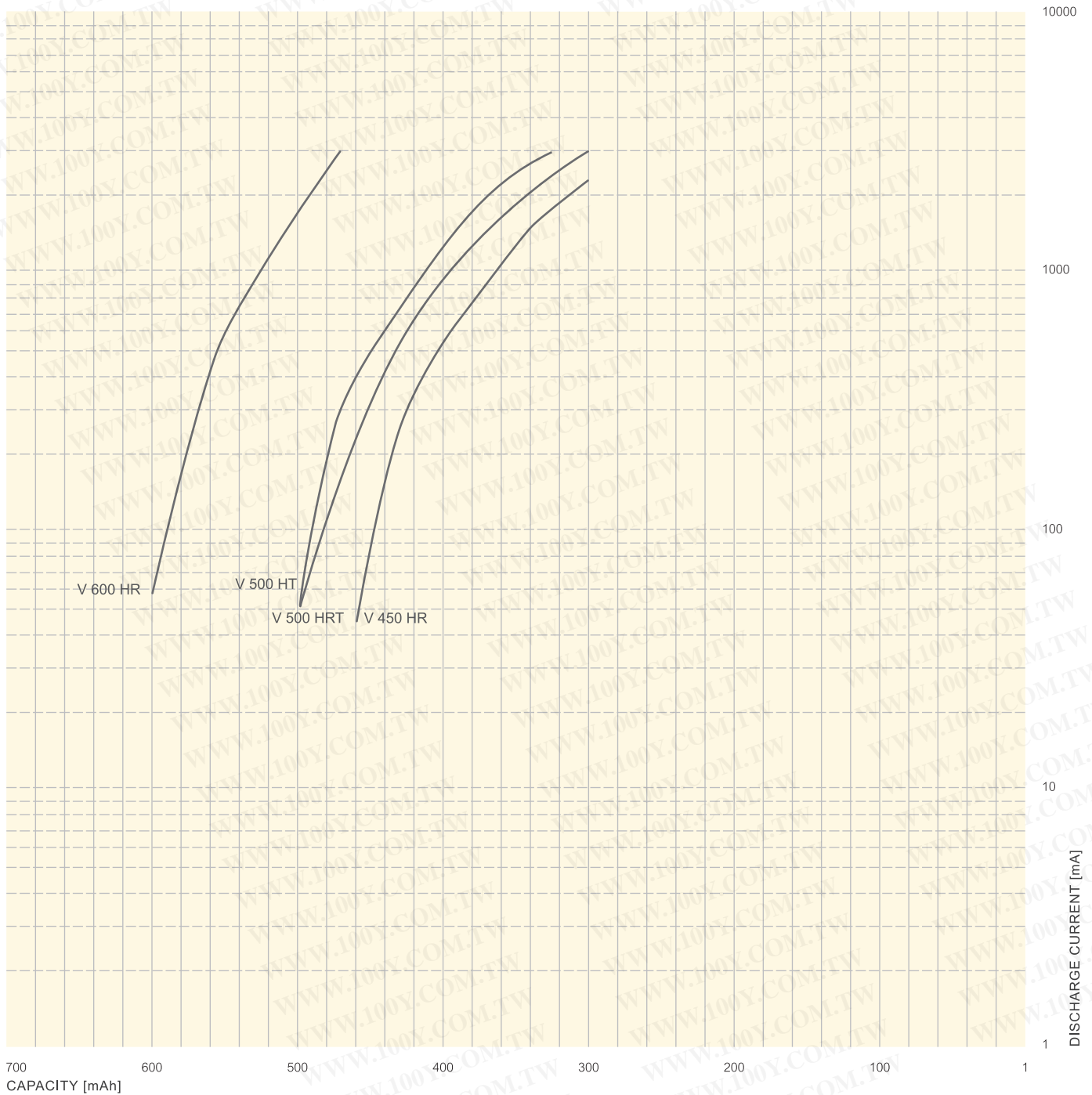

FIG. 37  
 Discharge characteristics V 600 HR, V 500 HRT, V 450 HR

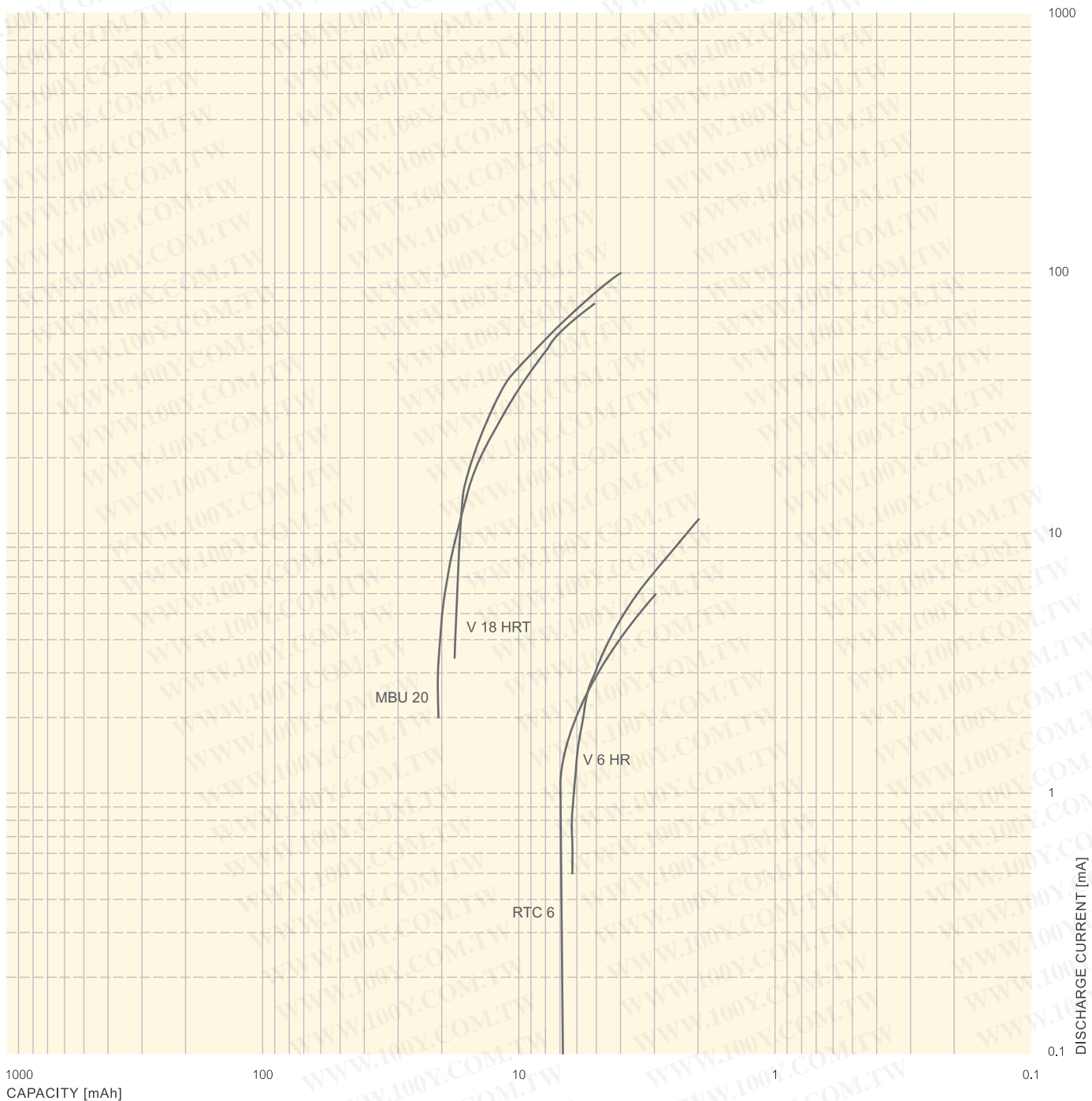

FIG. 38  
 Discharge characteristics MBU 20, V 18 HRT, V 6 HR, RTC 6

### 3.10 PERMISSIBLE TEMPERATURE RANGE

The NiMH High Rate Button Cells from VARTA Microbattery are suitable for use in a wide temperature range.

#### Operation Temperature During Charge

Charge efficiency is dependent on operating temperature. Due to the increasing evolution of oxygen at the positive electrode, charge efficiency decreases at higher temperatures. At low temperatures charge efficiency is excellent due to higher charge voltage. As the oxygen recombination process is slowed down at low temperature, a certain rise in internal cell pressure may occur depending on charge rate. The ranges of operation temperatures in Fig. 39 are permitted.

#### Operation Temperature During Discharge

Maximum capacity is obtained at an ambient temperature of about +24°C. There is a slight decrease of capacity at higher and lower temperatures especially at a longer period of time. This reduction in capacity is more pronounced at low temperatures and high discharge rates.

#### Charge Retention (Self-discharge)

Due to the self-discharge of the cells the stored capacity decreases over time. The self-discharge is dependent on temperature. The higher the temperature, the greater the self-discharge over time. Losses in capacity due to self-discharge are reversible within storage of  $\leq 12$  months within normal ambient conditions. After long-term storage up to three full cycles may be necessary to obtain full capacity.

In any case, please refer also to p. 42/43, 4.3 Proper use and Handling.

#### Series HR/HRT

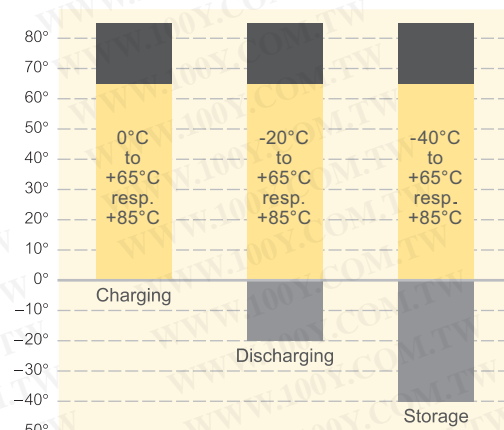

FIG. 39 Permissible temperature range for NiMH High Rate Button Cells (+65°C resp. +85°C, depending on type. See also p. 27)

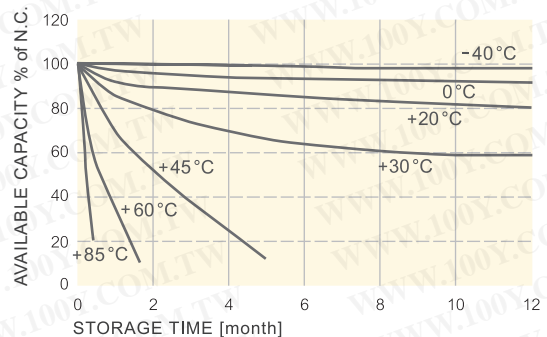

FIG. 40

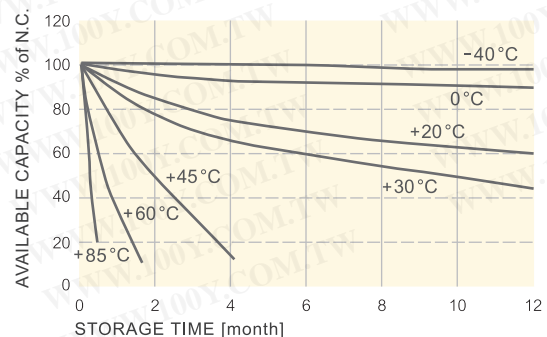

FIG. 41

FIG. 40 Self-discharge characteristics at different temperatures of V...H(T) robust family

FIG. 41 Self-discharge characteristics at different temperatures of V...HR(T) powerful family

## 4. GENERAL CHARACTERISTICS

### 4.1 REFERENCES

NiMH Button Cells from VARTA Microbattery (Made in Germany) are produced at an outstanding quality level in ISO 9001 certified facilities on fully automated lines. Process control in combination with various internal and external tests, e.g. UL Recognition tests, give our

customers the highest reliability and safety for their application. Our NiMH Button Cells are highly environmentally compatible due to an innovative Pb-, Hg- and Cd-free design.

#### UL Recognition

Currently the following NiMH Button Cells and batteries from VARTA Microbattery are recognized by Underwriters Laboratories Inc. under UL file number MH 13654 (N): V 6 HR, V18 HRT, V 450 HR, V 500 HRT, V 600 HR, V 15 H, V 40 H, V 80 H, V 110 HT, V 150 H, V 250 H, CP 300 H, V 350 H, V6/8 H, V7/8 H, V 65 HT, V 200 H, RTC 6, MBU 20, V 500 HT.

The NiMH Button Cells from VARTA Microbattery have certification for non-hazardous failure in the event of misuse or abuse such as:

- Charging at an excessively high rate
- Excessive reverse charge
- Short circuiting
- Exposure to open flame
- Crushing



Trademark of Underwriters Laboratories

#### Ecological Award

VARTA Microbattery gets the ecological award "Gläserner Baum 1998" of the German retail with its cadmium free NiMH Button Cells.



#### Lead-Free Soldering

Since 2003, VARTA Microbattery has successfully implemented lead-free soldering for all NiMH Button Cell assemblies. Under RoHS\*, lead is one of the hazardous substances which will be banned from use by 2006.

\* Restriction of the use of certain Hazardous Substances in electrical and electronics equipments

#### Customers

Various well-known companies from all kinds of electrical and electronics industries are our satisfied customers over many years.

EC-Directive for batteries is fulfilled  
 (Council Directive 91/157/EEC)

#### ISO 9001 + ISO 14001 Certification

The quality system of sealed rechargeable button cell and battery production from VARTA Microbattery is certified to ISO 9001 and ISO 14001. That means besides production also administration/management and R&D are continuously involved in defined improving processes regarding to changing market needs.



## 4.2 RELIABILITY AND LIFE EXPECTANCY

VARTA Microbattery NiMH Button Cells/Batteries are safe in normal usage and under anticipated conditions of unintentional abuse. Protective devices are incorporated into the cell/batteries to ensure maximum safety. For

- Long life expectancy:
  - Cycle application (IEC): up to 1,000 cycles
  - At trickle charge: up to 6 years at +20°C, up to 3 years at +45°C (up to 5 years at +45°C: V 65 HT, V 110 HT, V 150 HT)

confirmation of product safety extensive testing of typical abusive conditions has been performed. Features of the high reliability and long operating time at various applications are listed below and in Fig. 42, 43, 44 and 45:

- Wide temperature range for standard, high temperature and trickle charge applications
- High overcharge capability for simple, inexpensive charging circuits
- Excellent cell balance for robustness and high reliability

FIG. 42  
ROBUST FAMILY  
Life expectancy of robust family

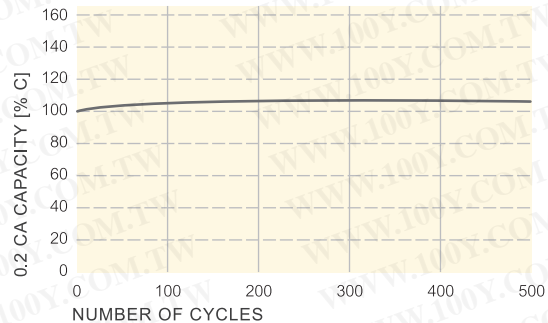

Cycling test by IEC 61951-2

FIG. 43  
ROBUST FAMILY

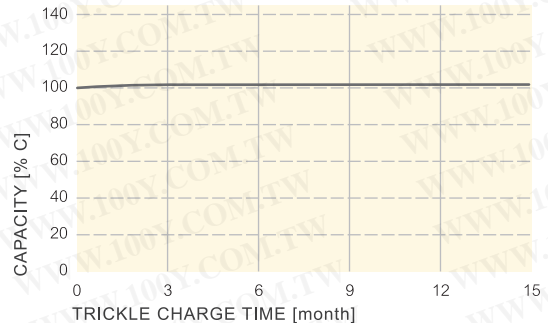

Trickle charge test at +45°C of NiMH Button Cells  
(trickle charge at 0.03 CA)

勝特力材料 886-3-5753170  
勝特力电子(上海) 86-21-34970699  
勝特力电子(深圳) 86-755-83298787  
[Http://www.100y.com.tw](http://www.100y.com.tw)



勝特力材料 886-3-5753170  
 勝特力电子(上海) 86-21-34970699  
 勝特力电子(深圳) 86-755-83298787  
[Http://www.100y.com.tw](http://www.100y.com.tw)

FIG. 44  
POWERFUL FAMILY

Life expectancy of  
V 450 HR, V 18 HRT

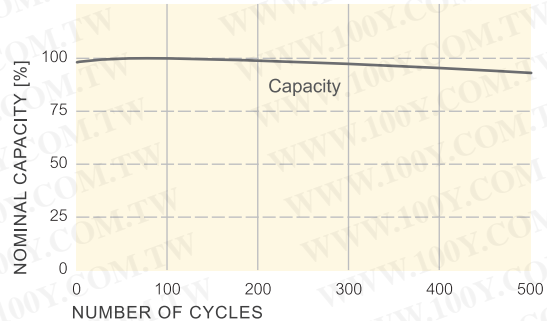
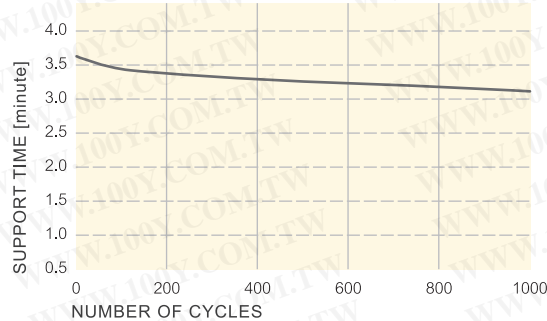

FIG. 45  
POWERFUL FAMILY  
Bridge battery life cycle test of  
V 18 HRT cell (bridging application)

Cycling Method:  
 Charge: 6 mA for 60 min.  
 Discharge: 100 mA to 0.8 V per cell



## 4.3 PROPER USE AND HANDLING

NiMH cells are sealed designs which are maintenance free. These products may be used in any operating position. They should be kept clean and dry during storage and operation. In general, batteries or cells will be shipped in a partially charged state. Therefore caution should be exercised not to short-circuit them at prolonged periods of time. Cells or batteries must be charged before use to obtain full capacity. Storage is

possible in any state of charge. Storage temperatures between  $-20^{\circ}\text{C}$  and  $+35^{\circ}\text{C}$  are recommended at a relative humidity of approximately 50%. In case of long-term storage cells and batteries should be recharged minimum once every year. In order to ensure performance expectations, the following conditions for use and handling are recommended.

### Charging

Charging should be conducted as previously described in "Charging Methods" (see page 18/30). Extended charging outside specified temperature ranges may have an adverse effect on cell life. Also permanent charging exceeding the limits of specified temperature ranges may reduce the battery life. The maximum life is achieved, when charging at an average temperature of  $+20$  to  $+30^{\circ}\text{C}$ .

### Cell reversal

In general, cell reversal should be avoided. If four or more cells are connected in series, it is necessary that these cells have matching capacities. The process of selecting cells of similar capacities is called "matching". For multicell configurations a cut off voltage of 1.0 V per cell or higher should be applied for discharge rates up to 1 CA. For configurations containing more than 6 cells in series and/or discharge rates exceeding 1 CA, please ask us for advice.

### Discharging

The specified temperature range is from  $-20$  to  $+60^{\circ}\text{C}$  resp.  $+85^{\circ}\text{C}$  on discharge. Repeated discharges at the extreme temperatures may affect battery life. In all applications do not deep-discharge ( $< 0.6$  V/cell) our NiMH cells and batteries.

### Short circuit protection

Because the internal resistance of NiMH cells and batteries is rather low, a prolonged short circuit will result in very high currents. This may lead to excessive heat generation and cell venting. Therefore prolonged short circuit must be avoided under all circumstances. The use of Polyswitch in battery configurations is recommended. Additional protection should be given to exposed battery terminals.

### Life Expectancy in Long-term use

Batteries are chemical products involving chemical reactions. Hence capacity and voltage will decrease over long time use as well as during long-term storage capacity and voltage will drop. Typically, a battery will last 5 years or 1000 IEC cycles, if used under recommended conditions and not overdischarged or overcharged. However, non-observance of recommended conditions concerning storage, charging, discharging, temperature and other factors during use can lead to shortened life expectancy of products and deterioration of performance.

### Severe use applications

Short term use of NiMH batteries outside specified ranges may be possible. Please consult us, if such a requirement exists.

## Deep Discharge (Over Discharge)

Deep discharge or reverse charging will damage the battery performance and must be avoided. In order to avoid over discharge of battery which is directly connected to an electronic circuitry, any leakage current must be reduced to minimum or better avoided completely. A switch or a deep discharge cut off device may be connected between battery and associated circuitry to prevent over discharge. We recommend to use such device in any case if battery with circuitry is shipped or stored. Please consult us for detailed design recommendations.

勝特力材料 886-3-5753170  
勝特力电子(上海) 86-21-34970699  
勝特力电子(深圳) 86-755-83298787  
[Http://www.100y.com.tw](http://www.100y.com.tw)

## Safety Guidelines

- Keep out of the reach of children. If swallowed, contact a physician at once
- Do not incinerate or mutilate, may burst or release toxic materials
- Do not short circuit, may cause burns
- Do not deep-discharge or discharge into reverse
- Do not solder on the battery directly (use our tagged versions)
- Restrict charging current and time to the recommended value
- Observe charging temperature: 0 to +65°C/+85°C
- Battery compartment should provide sufficient space for battery to expand in case of abuse
- Either battery compartment or battery connector should have a design that makes it impossible to place the battery in reverse polarity
- Equipment intended for use by children should have tamper-proof battery compartment
- Battery of different electrochemical system, grades, or brands should not be mixed
- Battery disposal method should be in accordance with local and state regulations

勝特力材料 886-3-5753170  
勝特力电子(上海) 86-21-34970699  
勝特力电子(深圳) 86-755-83298787  
[Http://www.100y.com.tw](http://www.100y.com.tw)

## CARE AND HANDLING

### 1. Connections and Terminals

Soldering of lead wires directly onto cells can damage the internal components like the gasket and other parts. It is recommended that a tag is spotwelded to the cell, on which lead wires can then be soldered. Never solder onto cells directly!

### 2. Parallel Cell Configuration

Parallel charging may produce unpredictable current distribution into cells. Therefore overcharge and low performing cells may result. When designing a battery where paralleling is needed, please consult us.

### 3. Contact Terminals

Battery assembly contact materials as well as contacts in battery holders should have a nickel surface for best corrosion resistance.

### 4. Battery Position

For optimum life batteries should be shielded or placed apart from heat sources.

### 5. Vented Battery Compartments

Airtight battery compartments are not allowed. Under abuse conditions cell venting may occur releasing hydrogen gas. It is therefore necessary for compartments to have an air ventilation.

### 6. Disassembly

Under no conditions should cells be disassembled. Cells contain potassium hydroxide electrolyte, which can cause injury. In the event that the electrolyte gets on skin or in eyes, immediately flush with water and seek medical advice.

### 7. Handling

Do not pull excessively on lead wires or connectors, as excessive force will cause product damage.

### 8. Incineration

Do not dispose of cells or batteries in a fire or in incinerator since rupturing and disassembly may occur.

### 9. Mixing of Cell Types

Do not put different cells and capacities in the same battery assembly! The mixed use of NiMH cells with NiCd cells, primary cells, old and new cells, cells of different sizes and capacities in one assembly can be dangerous and lead to either battery damage or poor performance of the device that it is intended to power.

## 4.4 TRANSPORTATION, SAFETY AND RECYCLING NOTE FOR BATTERIES

For latest version please see  
<http://www.varta-microbattery.com/top/trans-safe>

勝特力材料 886-3-5753170  
勝特力电子(上海) 86-21-34970699  
勝特力电子(深圳) 86-755-83298787  
[Http://www.100y.com.tw](http://www.100y.com.tw)

## 4.5 STORAGE/HANDLING

Sealed rechargeable NiMH Button Cells from VARTA Microbattery can be operated in any position.

Maintenance of the cells is not necessary, they are maintenance-free. However, the cells, like other electrical components, should be kept clean and dry. The cells complete the manufacturing process in a charged state. A considerable period of time can elapse due to assembly into battery units, storage and dispatch before they are taken into service by the customer. Because of time and temperature depending self-discharge, the state of charge upon receipt can not be precisely defined. Before use, therefore, sealed NiMH cells should be recharged.

To ensure long life and trouble-free operation, charging should be carried out as previously advised. Sealed NiMH cells can be stored for a long time without permanently losing capacity. Before storage the cells should be fully charged and must be disconnected from any load. The most advantageous storage temperatures are between +10°C and +35°C, at a relative humidity of approx. 50%. Cells should be protected from moisture and contamination.

Before putting into operation, stored cells should be recharged for 24 hours at the nominal charge rate or at a smaller current for a longer time. An extended charge process of two or three normal reconditioning cycles are necessary after longer storage. In this way the cells are reactivated and will achieve their "full capacity" i.e. the activatable present capacity after storage again.

Direct soldering onto the cells can lead to damage.

NiMH Button Cells/Batteries from VARTA Microbattery are available with different connectors, e.g. ring solder tags, solder lugs and plug solder lugs for printed circuits.

Button cells and button cell batteries for printed circuit board solder application can be flow soldered in the charged state as long as the soldering time does not exceed 10 secs. The preheating period should also be limited to approx. 10 secs. The specified temperature limits should also be observed with the "Burn-in" tests. Consult VARTA Microbattery with regard to the compatibility of cleaning materials for printed circuit boards.

For NiMH Button Cells from VARTA Microbattery there are no restrictions regarding to their operating positions.

In general, referring to NiMH batteries – as for any battery – please remember:

- Do not short-circuit
- Do not damage
- Do not incinerate
- Do not handle out of specification
- Keep out of reach of children. If swallowed, contact a physician at once

勝特力材料 886-3-5753170  
勝特力电子(上海) 86-21-34970699  
勝特力电子(深圳) 86-755-83298787

[Http://www.100y.com.tw](http://www.100y.com.tw)

## 4.6 BATTERY ASSEMBLY

### Connection and Terminals

Never solder onto cells directly! Soldering of lead wires directly onto cells can damage the internal components like the sealing ring and other parts. It is recommended that a tag is spotwelded to the cell, on which lead wires can then be soldered.

### Parallel Cell Configuration

Never connect cells in parallel during charging!  
Parallel charging may produce unpredictable current distribution into cells. Therefore overcharge and low performing cells may result.  
Parallel discharging may result in discharging of one cell to another. Therefore, it is necessary to use blocking diodes between cells connected in parallel on discharging. When designing a battery where paralleling is needed, please consult us.

### Disassembly

Under no conditions should cells be disassembled. Cells contain potassium hydroxide electrolyte, which can cause injury. In the event that the electrolyte gets on skin or in eyes, immediately flush with water and seek medical advice.

### Incineration

Do not put cells or batteries in fire!

### Mixing of Cell Types

Do not put different cells and capacities in the same battery assembly!  
The mixed use of NiMH cells with NiCd cells, primary cells, old and new cells, cells of different sizes and capacities in one assembly can lead to either battery damage or poor performance of the device that it is intended to power.

### Contact Materials

Battery assembly contact materials as well as contacts in battery holders should have a nickel surface for best corrosion resistance.

### Battery Position in Devices

For optimum life batteries should be shielded or placed apart from heat sources.

### Handling

Do not pull excessively on lead wires or connectors, as excessive force will cause product damage.

勝特力材料 886-3-5753170  
胜特力电子(上海) 86-21-34970699  
胜特力电子(深圳) 86-755-83298787  
[Http://www.100y.com.tw](http://www.100y.com.tw)

## 4.7 MULTICELL BATTERIES

### BATTERY ASSEMBLY RECOMMENDATION

#### 1. Connection between Cells

When NiMH cells are connected, spotwelding methods are to be used. This is to avoid excessive temperature rise of the cell which would occur if soldered on to them. Tags used for cell connections should be nickel plated. They should have a 0.1–0.2 mm thickness and be 3–6 mm wide.

The temperature of NiMH cells or batteries rises when the charge gets close to completion. Temperature rise is larger for a battery pack than for a single cell because of different heat dissipation; the temperature rise is even greater when the cells are enclosed in a plastic case. In the final stage of the charging period the temperature of cells enclosed in a plastic case becomes about +10°C higher than in the case of cells with wide spacing. The charge efficiency also decreases with an increase in temperature.

Therefore, when a NiMH battery is being designed, it is important to make provisions for a temperature rise during charge as low as possible by means of facilitating good heat dissipation. This is achievable with appropriate design of the plastic case surface.

Air ventilation should be provided in the plastic cases of batteries to allow for egress of any gasses which may result from activation of the PRV of cells after abuse. Deflection space should be considered in the battery compartment to assure proper function of PRV.

#### 2. Thermal Protection for Battery Packs

Battery packs exceeding 3 cells intended for fast charging methods (HR and HRT-Family) need to have a thermal protection device. A thermistor (NTC) which allows the charger sensing the temperature inside the pack is to be implemented. An accuracy of 1% of such device is recommended.

勝特力材料 886-3-5753170  
勝特力电子(上海) 86-21-34970699  
勝特力电子(深圳) 86-755-83298787  
[Http://www.100y.com.tw](http://www.100y.com.tw)



## 4.8 DEFINITIONS

### Basically

Unless otherwise stated the technical values and definitions are based on room temperature conditions (R.T. = 20°C ± 2°C).

### System – specific data

The gravimetric energy density of the NiMH system depends on battery size and ranges from approx. 40–55 Wh/kg and the volumetric energy density ranges from approx. 120–180 Wh/l.

### Voltage Definitions

Open Circuit Voltage (O.C.V.):  
Equilibrium potential 1.25 V to 1.4 V on average, dependent on temperature, storage duration and state of charge.

Nominal Voltage of sealed NiMH button cells is 1.2 V.

End of Discharge Voltage (VE):  
The voltage at the end of discharging is 1.2 V to 0.9 V per cell, depending on discharge rate and temperature.

End of Charge Voltage:  
Terminal voltage after charge of 14 to 16 hours at the nominal rate 0.1 CA, about 1.45 V/cell at room temperature.

### Capacity Definitions

The Capacity C of a cell is defined by the discharge current I and the discharge time t:  $C = I \cdot t$

I = constant discharge current  
t = duration from the beginning of discharge until the end of discharge voltage is reached

Nominal Capacity:

The nominal capacity C denotes in quantity of electricity in mAh (milli-Ampère hours) that the cell can deliver at the 5 h discharge rate (0.2 CA). The reference temperature is 20°C ± 2°C, and the final discharge voltage 1.0 V.

Typical Capacity:

The typical capacity is the average capacity at a discharge rate of 0.2 CA to a final discharge voltage of 1.0 V.

Available Capacity:

NiMH cells deliver their nominal capacity at 0.2 CA. This assumes that charging and discharging is carried out as recommended. Factors which affect the available capacity are:

- Rate of discharge
- End of discharge voltage
- Ambient temperature
- State of charge

At higher than nominal discharge rates the available capacity is correspondingly reduced.

### Current Definitions

Charge and discharge rates are given as multiples of the nominal capacity (C) in ampères (A) with the term CA.

Example:

Nominal capacity C = 100 mAh  
0.1 CA = 10 mA, 1 CA = 100 mA

Nominal Charge Current:

The nominal charge current is the charge rate (0.1 CA) which is necessary to achieve full charge of a cell in 14 to 16 hours, if the cell has been fully discharged.

Overcharge Current:

Permissible current 0.1 CA for occasional overcharging not exceeding 1 year. Frequent overcharge reduces cell/battery life. Overcharge is restricted to room temperature. Occasional discharges reinstitute the original performance.

Permanent Charge Current:

Recommended current 0.03 CA for capacity retention (also known as trickle charge current).

Nominal Discharge Current:

The nominal discharge current of a NiMH cell is the 5 hour discharge current (0.2 CA). It is current at which the nominal capacity of a cell is discharged in 5 hours.

$$I = \frac{C}{t} = \frac{C}{5} = 0.2 \text{ CA when } t = 5 \text{ h}$$

## Ah-Efficiency

The ratio of effective available capacity and capacity input is denoted as charge efficiency.

$$\eta_{Ah} = \frac{\text{available capacity}}{\text{capacity input}}$$

$\eta_{Ah}$  is dependent on cell type, charge rate, cell temperature and discharge rate. In case of nominal conditions maximum hAh value is approximately 0.8, that means at least 125% charge input of nominal capacity is necessary. In practice a charge input of 140 to 160% at the nominal charge current is recommended.

**勝特力材料 886-3-5753170**  
**勝特力电子(上海) 86-21-34970699**  
**勝特力电子(深圳) 86-755-83298787**  
**Http://www.100y.com.tw**

Subject to change without further notice.  
 No responsibility for the correctness of this information.  
 For latest technical data please refer to our data sheets which you will find on our website [www.varta-microbattery.com](http://www.varta-microbattery.com).

© by VARTA Microbattery GmbH

## 4.9 APPLICATION CHECK LIST

CUSTOMER:		APPLICATION:	
Volume cells per year:		Samples requested:	
Target Price:		Delivery required:	
Min. operating voltage $V_B$ :	(V)	Max. $V_B$	(V)
Operating time required:	Hours:	Days:	Month:
DISCHARGE conditions at:	Min. temperature: (°C)	Max. temperature: (°C)	
Discharge mode (A)	(mA)	Operating time	Per discharge
Continuous discharge			Pulse number
Pulse discharge			Min. Hr. Days
Max. current		<input type="checkbox"/>	<input type="checkbox"/> <input type="checkbox"/>
Min. current		<input type="checkbox"/>	<input type="checkbox"/> <input type="checkbox"/>
CHARGE CONDITIONS AT:	Min. temperature: (°C)	Max. temperature: (°C)	
Required charge method:			
<input type="checkbox"/> Standard charge	<input type="checkbox"/> Accelerated charge	<input type="checkbox"/> Limited fast charge	<input type="checkbox"/> Trickle charge
Preferred charge termination method:			
Available charging current:			
Charge time available:	Minutes:	Hours:	Days:
Further information on charging:			
CONSTRUCTIONAL AND MECHANICAL REQUIREMENTS:			
Space available:	Length: (mm) x	Width: (mm) x	Height: (mm)
Requested battery type	Type of battery form:		
	Type of terminals:		
Qualification test procedures of the customer:			

## Product Portfolio

Primary Batteries					
	Silver Oxide Button Cells		Lithium-Manganese Cells Lithium-Thionyl-Chloride Cells		Zinc Air Cells
	Alkaline Batteries		Lithium Button Cells		
Rechargeable Batteries					
	Li-Polymer		NiMH Button Cells (V...H / HR / HT / HRT)		Cylindrical & Prismatic Li-Ion & NiMH Cells

## Contacts

**Germany and Central Europe**  
**VARTA Microbattery GmbH**  
 Daimlerstrasse 1  
 73479 Ellwangen, Germany  
 Tel +49 79 61 921 - 0  
 Fax +49 79 61 921 - 553

### Americas

VARTA Microbattery, Inc.  
 1311 Mamaroneck Avenue, Suite 120  
 White Plains, NY 10605, USA  
 Tel +1 914 592 25 00  
 Fax +1 914 345 04 88

### UK and Ireland

VARTA Microbattery GmbH  
 17 Progress Business Centre,  
 Whittle Parkway, Slough SL 1 6DQ, GB  
 Tel +44 16 28 60 79 30  
 Fax +44 16 28 60 79 39

### France

VARTA Microbattery SARL  
 12 - 14, Rue Raymond RIDEL  
 92250 La Garenne Colombes, France  
 Tel +33 1 47 84 84 54  
 Fax +33 1 47 84 28 32

### Asia Pacific

VARTA Microbattery Pte. Ltd.  
 300, Tampines Avenue 5, #05-01  
 Tampines Junction, 529653 Singapore  
 Tel +65 6 260 58 01  
 Fax +65 6 260 58 12

### China

VARTA Microbattery Pte. Ltd.  
 Room 1702-3, 17/F., Fullerton Centre  
 19 Hung to Road, Kwun Tong  
 Kowloon, Hongkong  
 Tel +852 28 98 83 73  
 Fax +852 28 97 76 09

VARTA Microbattery (Shanghai) Co. Ltd.  
 Block 3, Shanghai Pudong Chuansha  
 Industrial Park  
 No. 6999 Chuansha Road  
 Pudong New Area  
 201202 Shanghai, China  
 Tel +86 21 58 59 83 85  
 Fax +86 21 58 59 33 13

### Japan

VARTA Microbattery Pte. Ltd.  
 Kyobashi Y'SUS Bldg, 3F.1-6-12, Kyobashi,  
 Chuo-Ku  
 Tokyo 104-0031, Japan  
 Tel +81 3 35 67 81 71  
 Fax +81 3 35 67 81 75

### Taiwan

VARTA Microbattery Pte. Ltd.  
 11F-4, No.130, Section 2  
 Chung Hsiao East Road  
 Taipei 10053, Taiwan  
 Tel +886 2 33 93 15 57  
 Fax +886 2 33 93 15 56

**Distributors** Distributors and representations in all major countries worldwide. Please see webpage.  
**Internet** [www.varta-microbattery.com](http://www.varta-microbattery.com).  
 For e-mail contact please visit: <http://contact.varta-microbattery.com>.

[www.varta-microbattery.com](http://www.varta-microbattery.com)

VARTA Microbattery is a company of  
**Montana Tech Components AG,**  
 Hauptstrasse 35, 5737 Menziken, Switzerland  
[www.montanatechcomponents.com](http://www.montanatechcomponents.com)

**MONTANA**  
 TECH COMPONENTS

勝特力材料 886-3-5753170  
 勝特力电子(上海) 86-21-34970699  
 勝特力电子(深圳) 86-755-83298787  
[Http://www.100y.com.tw](http://www.100y.com.tw)