



勝特力材料 886-3-5753170
勝特力电子(上海) 86-21-34970699
勝特力电子(深圳) 86-755-83298787
[Http://www.100y.com.tw](http://www.100y.com.tw)

Connection Terminal Specifications for Lithium Batteries and Key Circuit Design Points

Connection Terminal Specifications for Lithium Batteries and Key Circuit Design Points

When choosing batteries, the rating of the device, operating load conditions, and operating temperature range should be considered. Also, when deciding connection terminal configuration, battery installation space and battery fixation method should be considered. Refer to the lithium battery section of the battery selection guide (p12).
 When planning circuit design, please keep in mind that there is a large difference between primary and rechargeable lithium batteries. The properties of each design must be completely understood before implementation.
 Please consult SANYO for further details or inquiries.
 SANYO standard configuration and model No. display methods are as shown below.
 Standard SANYO specifications are given starting on page 1.

Tab specification

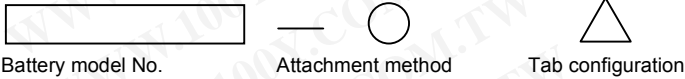

Battery model No.
 Attachment method (to a PC board)
 H : Horizontal attachment
 V : Vertical attachment
 T : Surface mount attachment
 Z : Special attachment

Tab configuration

T : Flat board (width 3mm)
 I : Flat board (top width; 0.5 ~ 1.9mm)
 H : Flat board with hole (top width; 3.0 ~ 3.9mm)
 L : Flat board with hole (top width; over 4mm)
 J : Top J type
 M : Top pin type
 R : 3 terminal type (corner R ant)
 S : 3 terminal type (corner R pear)
 Z : Special

Lead wire specification

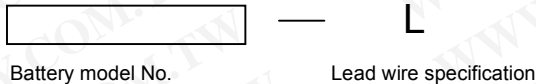

Battery model No. Lead wire specification

Connector specification



Battery model No. Connector specification

勝特力材料 886-3-5753170
 胜特力电子(上海) 86-21-34970699
 胜特力电子(深圳) 86-755-83298787
[Http://www.100y.com.tw](http://www.100y.com.tw)



[Primary Lithium Batteries]

Sanyo has anticipated a wide range of user requirements by developing a line of batteries with a variety of different terminal designs (tab, connector and other terminals), as well as holders for simple mounting and greater flexibility. Standard specifications are described below. Consult Sanyo for other specifications. Dimensions are for reference only. Consult Sanyo for details.

Tab specification

Coin Type Primary Lithium Batteries

Model	Capacity (mAh)	Insulating tube	Dimensions (mm)							Material of terminal	Fig.	
			A	B	C	D	E	F	G			
CR2032-TT2	220	no	20.0	3.2	3.4	10.0					0.1t Ni-Cu alloy	Fig. 1
CR2430-TT2	280	no	24.5	3.0	3.3	10.0					0.15t Ni-Cu alloy	
CR2450-TT2	610	no	24.5	5.0	5.3	10.0					0.15t Ni-Cu alloy	
CR2025-TT2	150	no	20.5	2.5	2.9	⊕ \ominus 5.0					0.15t Ni-Cu alloy	
CR1220-TJ1	36	yes	13.0	2.0	2.8	3.1	⊕ \ominus 2.5	3.8			0.2t stainless steel	Fig. 2
CR2032-T19	220	no	20.0	3.2	3.6	6.3	5.0	18.0			0.15t Ni-Cu alloy	Fig. 3
CR2450-T8	610	yes	25.0	5.0	5.4	6.3	5.0	20.3			0.15t Ni-Cu alloy	Fig. 4
CR1220-P1	36	no	12.5	2.0	2.8	6.2	5.0	10.0	3.25		0.2t stainless steel	
CR2032-P5-1	220	no	20.0	3.2	4.0	8.7	5.0	15.2			0.2t stainless steel	Fig. 5
CR2032-P5-2	220	yes	20.5	3.2	4.0	8.7	5.0	15.2			0.2t stainless steel	
CR2430-P1-2	280	no	24.5	3.0	3.8	6.2	5.0	20.3			0.2t stainless steel	
CR2450-P2	610	no	24.5	5.0	5.8	6.2	5.0	20.3			0.2t stainless steel	
CR2032-H5	220	yes	20.5	3.2	4.0	5.0	3.5	20.5			0.2t stainless steel	Fig. 6
CR2032-VM1	220	yes	20.5	3.2	5.2	5.0		4.2	⊕10.5		φ0.8 nickel wire	Fig. 7
CR2430-P2	280	yes	25.0	3.0	5.0	5.0		4.0	⊕10.5		φ0.8 nickel wire	
CR2032-FT10	220	no	20.0	3.2	4.0	5.6	4.0	17.8	⊕10.2		0.2t stainless steel	Fig. 8
CR2430-FT10	280	no	24.5	3.0	3.8	5.6	4.0	17.8	⊕10.2		0.2t stainless steel	
CR2450-FT2-1	610	no	24.5	5.0	5.8	4.6	4.0	17.8	⊕10.2		0.2t stainless steel	Fig. 9
CR2032-FT4-2	220	yes	20.5	3.2	4.0	5.0	4.0	3.8	⊕10.2		0.2t stainless steel	
CR2430-FT4-2	280	yes	25.0	3.0	3.8	5.0	4.0	3.6	⊕10.2		0.2t stainless steel	
CR2450-FT5-4	610	no	24.5	5.0	5.8	5.0	4.0	5.6	⊕10.2		0.2t stainless steel	

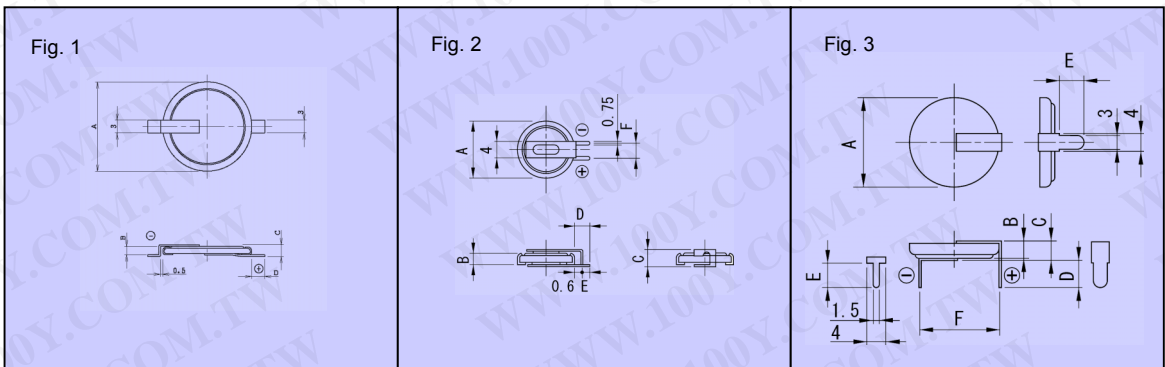

Stainless tab and nickel wire are solder plated.

勝特力材料 886-3-5753170
 勝特力电子(上海) 86-21-34970699
 勝特力电子(深圳) 86-755-83298787
[Http://www.100y.com.tw](http://www.100y.com.tw)

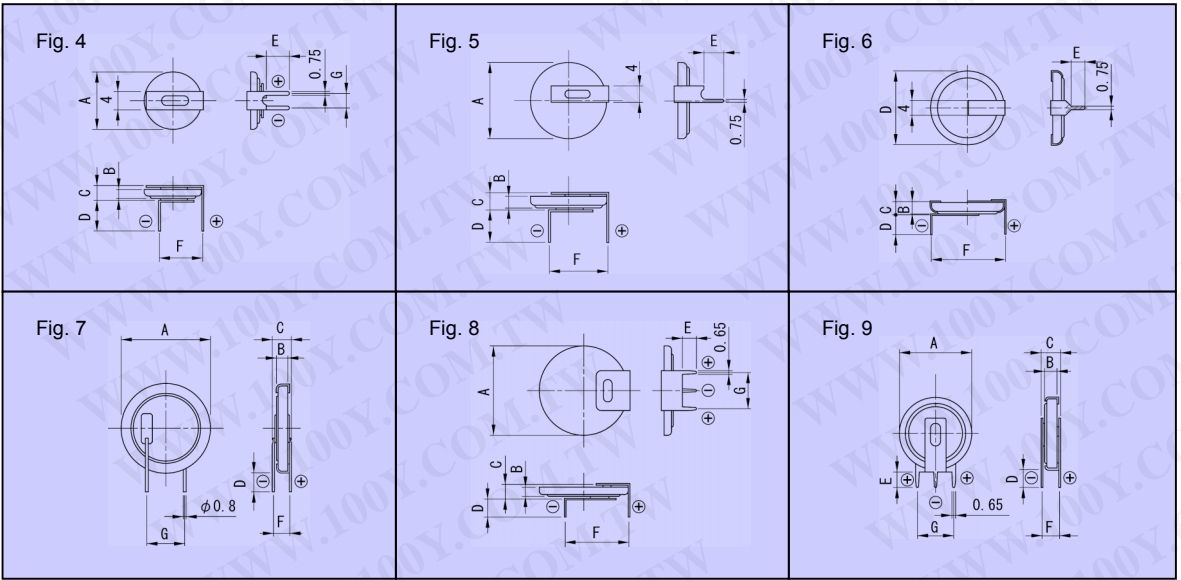

Stainless tab and nickel wire are solder plated.

High-power Cylindrical Type Primary Lithium Batteries

Model	Capacity (mAh)	Insulating tube	Dimensions (mm)							Material of terminal	Fig.
			A	B	C	D	E	F	G		
CR-1/3N-P1-1	160	yes *	11.6	10.8	12.8	7.2		11.8		$\phi 0.8$ nickel wire	Fig. 10
CR15270-HM2	850	yes	15.5	27.0	29.0	6.0		27.0		$\phi 0.8$ nickel wire	Fig. 11
CR17450E-R-HH2	2200	yes	17.0	45.0	45.3	3.5		45.0		0.15t Ni-Cu alloy	Fig. 12
CR-1/3N-FT1	160	yes *	11.6	10.8	11.5	5.5	4.0	11.0	$\oplus 10.2$	0.15t Ni-Cu alloy	Fig. 13
CR15400-FT1	1400	yes	15.5	40.0	40.8	5.1	4.0	40.5	$\oplus 7.5$	0.3t stainless steel	Fig. 14
CR17335-HR1	1400	yes	17.0	33.8	34.6	5.1	4.0	34.3	$\oplus 7.5$	0.3t stainless steel	Fig. 15
CR17335E-R-HR1	1500	yes	17.0	33.5	34.3	5.1	4.0	34.0	$\oplus 7.5$	0.3t stainless steel	Fig. 20
CR17335HE-R-HR1	1350	yes	17.0	33.5	34.3	5.1	4.0	34.0	$\oplus 7.5$	0.3t stainless steel	
CR17450E-R-HR1	2200	yes	17.0	45.0	45.8	5.1	4.0	45.5	$\oplus 7.5$	0.3t stainless steel	
CR17450HE-R-HR1	2000	yes	17.0	45.0	45.8	5.1	4.0	45.5	$\oplus 7.5$	0.3t stainless steel	

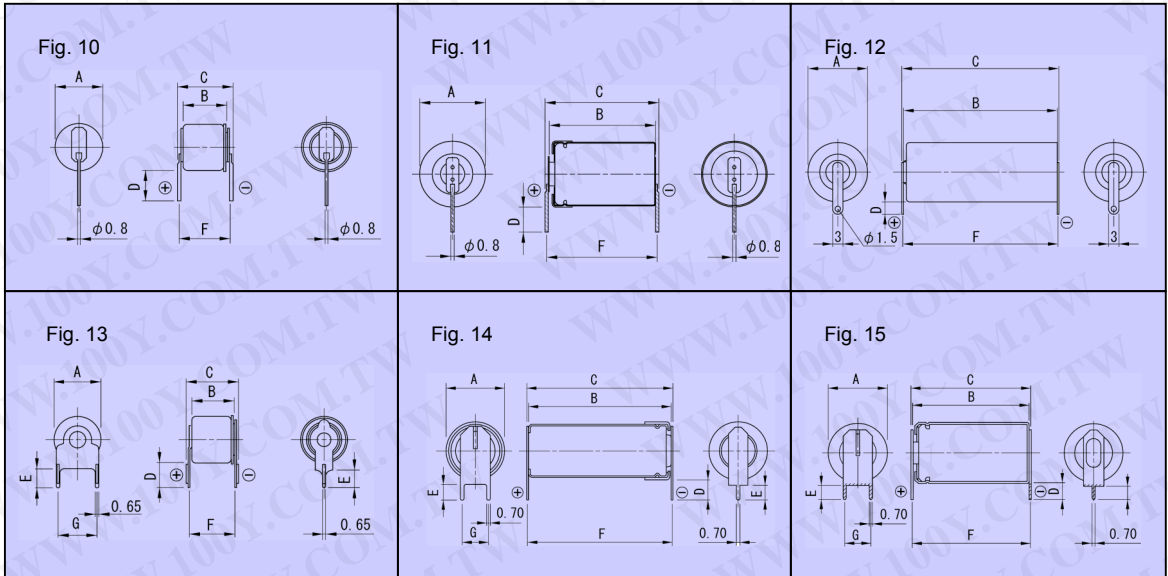

Stainless tab and nickel wire are solder plated.

* Provided with insulating sleeve instead of insulating tube.

High-capacity Cylindrical Type Primary Lithium Batteries

Model	Capacity (mAh)	Dimensions (mm)							Material of terminal	Fig.
		A	B	C	D	E	F	G		
CR14250SE-T1	850	14.5	25	25.3	5		25		0.15t Ni-Cu alloy	Fig. 16
CR17335SE-T1	1800	17	33.5	33.8	4.5		33.5		0.15t Ni-Cu alloy	
CR17450SE-T1	2500	17	45	45.3	7.5		45		0.15t Ni-Cu alloy	
CR23500SE-T1	5000	23	50	50.3	5		50.5		0.15t Ni-Cu alloy	
CR14250SE-HH2	850	14.5	25	25.3	3.5		25		0.15t Ni-Cu alloy	Fig. 17
CR12600SE-T1	1500	12	60	60.3	10		59		0.15t Ni-Cu alloy	
CR17335SE-T4	1800	17	33.5	33.8	3.5		33.5		0.15t Ni-Cu alloy	
CR14250SE-SP1-1	850	14.5	25		33				φ0.8 nickel wire	Fig. 18
CR17335SE-HM1	1800	17	33.5		33				φ0.8 nickel wire	
CR14250SE-P1-1	850	14.5	25	27	7		26		φ0.8 nickel wire	Fig. 19
CR14250SE-P3	850	14.5	25	25.8	5.1	4	25.5		0.3t stainless steel	Fig. 20
CR12600SE-P3	1500	12	60	60.8	5.1	4	59		0.3t stainless steel	
CR17335SE-P3	1800	17	33.5	34.3	5.1	4	34		0.3t stainless steel	
CR17450SE-P3	2500	17	45	45.8	5.1	4	45.5		0.3t stainless steel	
CR14250SE-FT1	850	14.5	25	25.8	5.1	4	25.5	(+)7.5	0.3t stainless steel	Fig. 21
CR12600SE-FT3	1500	12	60	60.8	5.1	4	59	(+)7.5	0.3t stainless steel	
CR17335SE-FT1	1800	17	33.5	34.3	5.1	4	34	(+)7.5	0.3t stainless steel	
CR17450SE-FT1	2500	17	45	45.8	5.1	4	45.5	(+)7.5	0.3t stainless steel	

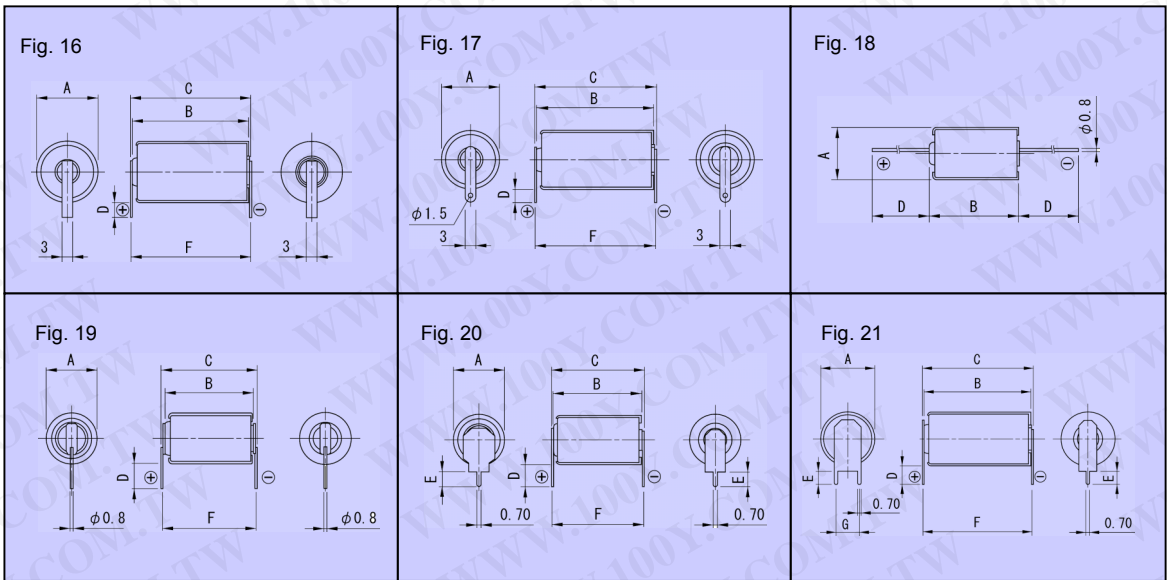

Stainless tab and nickel wire are solder plated.
Provided with insulating tube.

High-capacity cylindrical-type unit cell batteries are not nickel-plated. Do not use unit cells directly. Always use with the connection terminals.

Assembled Primary Lithium Batteries with Connectors

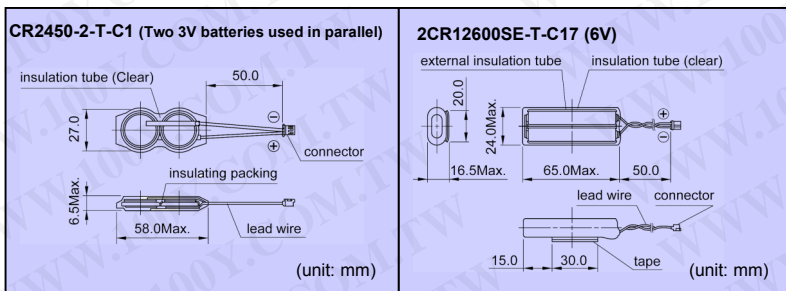

勝特力材料 886-3-5753170
 勝特力电子(上海) 86-21-34970699
 勝特力电子(深圳) 86-755-83298787
[Http://www.100y.com.tw](http://www.100y.com.tw)

Battery Holders (For Primary Lithium Batteries)

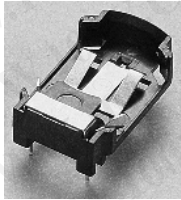

20H-1

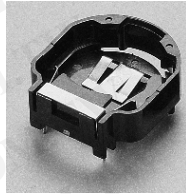

24H-1

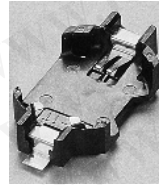

20H-1T

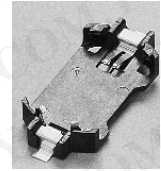

24H-2T

Through-hole Mounting Type

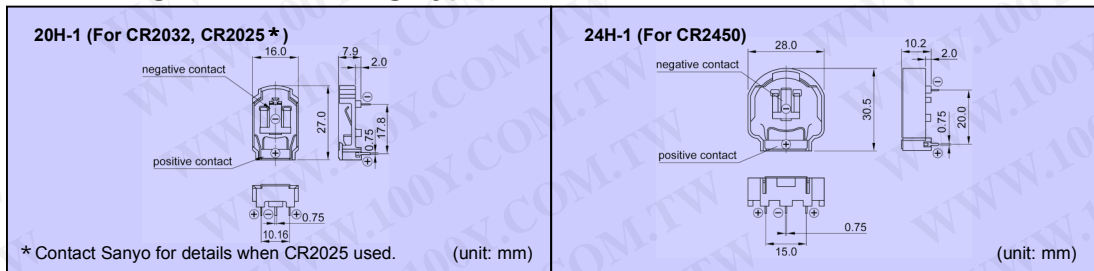

Features

- Easy battery replacement.
- Simple mounting on the PCB.
- Designed so that batteries cannot be easily inserted in reverse polarity.
- Rigid battery fixing.

Specifications

Holder material is modified PPE and satisfies UL94V-1. (20H-1)
 Holder material is modified PPE and satisfies UL94V-0. (24H-1)
 For the terminal material, 0.25t of stainless steel plate is nickel-plated.
 The connection resistances of (+) and (-) terminals are under 100m (1kHz through AC method).

Surface Mounting Type

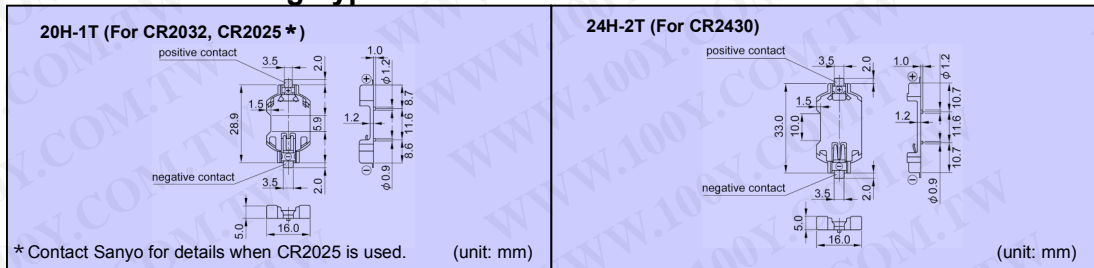

Features

- Easy battery replacement.
- Superior heat-resistant property allows reflowing. (When mounting battery with a reflowing system, first solder a holder on PCB, then place the battery in it. Contact Sanyo for further details.)
- Compact and slim design requires minimal space.
- Rigid battery fixing.

Specifications

Holder material is PPS and satisfies UL94V-0.
 For the terminal material, 0.2t of stainless steel plate is nickel-plated and the top is soldered.
 The connection resistances of (+) and (-) terminals are under 100m (1kHz through AC method).

[Primary Lithium Batteries for Memory Backup Key Design Points]

Selecting Batteries

When considering the relationship between load current and battery durability, please keep in mind that you must select the appropriate battery to meet load, current and expected durability of the equipment. The operating voltage of primary lithium batteries tends to decrease as the temperature decreases. The current consumption of ICs tends to lessen as the temperature decreases. Please take these points into account when selecting batteries. The relationship between load current and discharge time are shown as follows:

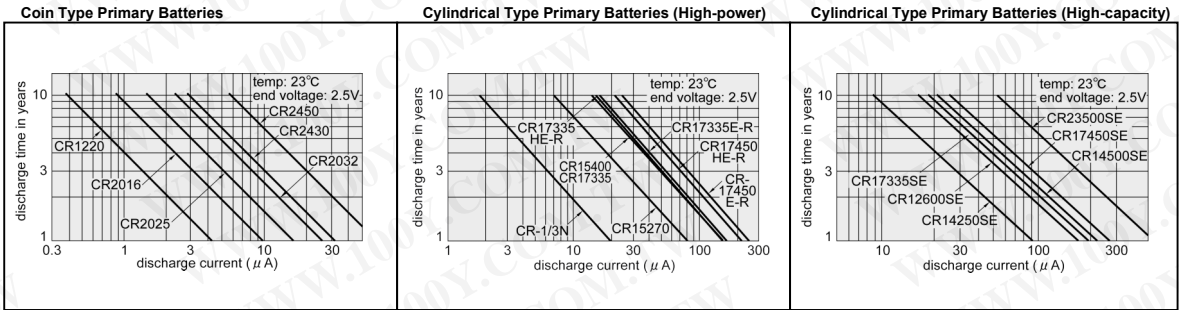

Important Points For Designing

Battery life is determined based on load current of IC (CMOS, SRAM) and memory retaining voltage. Pay special attention to the following points in order to make full use of the superior characteristics of lithium primary batteries.

Battery Voltage for Memory Backup

The ordinary memory backup circuitry is shown below:

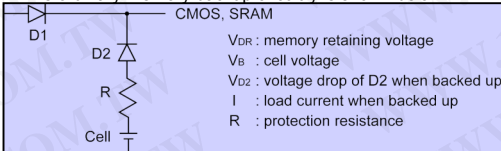

Minimum battery voltage for memory backup is required as follows: $V_B > V_{DR} + V_{D2} + I \times R$

Using Reverse Flow Prevention Diodes

Lithium primary batteries are not rechargeable. If there is any possibility of electric current flowing from the main power source to the battery, be sure to use one reverse flow prevention diode and one protective resistor in series. (In accordance with UL regulations, when lithium primary batteries are used as an equipment backup power source, one diode and one protective resistor must be used in series.)

Protective Resistor

A protective resistor is necessary in order to reduce the charging current when the diode fails. According to UL regulations, the charging current when the diode fails should not exceed the value shown in the table on page 6.

For example, in the circuit (1) shown below, when battery model CR2016 is used in combination with a 5V main power source. The maximum allowable current is 10mA.

$$5V\text{-cell voltage} \quad R \times 10mA$$

$$\text{In this case, cell voltage} = 0, R = 500$$

Therefore, a protective resistor over 500 Ω is required.

Allowable Charging Amount Through the Diode

As shown in the circuit example (left figure), if there is any possibility that the battery will be charged by D2 reverse current, please observe the following.

Use a silicon diode with a small leakage current type or a Schottky diode and design the circuit so that the total charging amount through the diode does not exceed 3% of the battery's nominal capacity during the total period of use. Within this level, the adverse effect on battery performance is extremely small. For instance, when CR12600SE (nominal capacity of 1500mAh) is used for 10 years, the total charging amount due to diode leakage current is $1500 \times 0.03 = 45\text{mAh}$. Dividing by a 10-year period:

$$45 \div (10 \times 365 \times 24) = 0.0005 \text{ (mA)}$$

Therefore, leakage current diode under $0.5 \mu A$ is required.

Circuit Sample

Using a single 3V cell (UL conditions)

- (1) When one reverse flow prevention diode and one protective resistor are used in series.

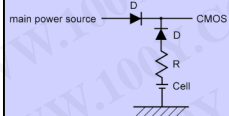

Using 2 cells

- (2) When 6V is used in series.

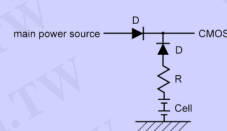

- (3) When 3V is used in parallel.

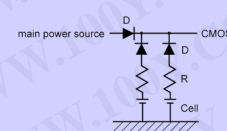

D: reverse flow prevention diode R: protective resistor Cell: primary lithium battery

勝特力材料 886-3-5753170
 勝特力电子(上海) 86-21-34970699
 勝特力电子(深圳) 86-755-83298787
[Http://www.100y.com.tw](http://www.100y.com.tw)

Battery Arrangement

When the battery is placed close to components that generate heat, the battery may become hot. This may cause deformation of the gasket material, resulting in leakage and inferior performance.

Soldering

When soldering is required, use a battery equipped with a connection terminal. Do not apply solder directly to the battery. Hand soldering should be done as quickly as possible (within 5 seconds) at a temperature from 250 to 350. If too much solder is used, solder may flow under the battery onto the PC board, causing battery leakage or deterioration of battery characteristics. Be especially careful when the battery and PC board are positioned close together. For automatic soldering, apply at 250 ~ 270 within 5 seconds. If the battery is kept above the soldering bath for a long time, or if it is dropped into the soldering bath, it may burst open due to overheating. To avoid leakage due to thermal deformation of the gasket material or deterioration of battery performance, make sure that the battery temperature does not exceed 85. Consult Sanyo for details when soldering is applied with a reflowing system.

The graph on the right shows open voltage recovery characteristics after a presumed short circuit during automatic soldering.

Cleaning and Drying

The use of a solvent with electrical conducting properties may cause the battery to short circuit, resulting in the deterioration of the battery's performance. If the temperature rises above 85 when drying, the gasket becomes thermally deformed. This may cause leakage or inferior battery performance. Be sure not to exceed 85 when drying.

Storage of Batteries

Store batteries in a dry place that is not exposed to direct sunlight and has little temperature fluctuation. Storage at high temperatures or high humidity may influence the battery's performance.

Recommended storage conditions:
 temperature: 10 to 30
 relative humidity: under 60%

Battery Replacement for UL

According to UL regulations, batteries must be replaced by trained technicians. However, the models other than those marked with asterisks can be replaced by users, if certain conditions are satisfied. Consult Sanyo for details.

- 1) The end product must be designed to prevent reverse polarity installation of the battery. If the battery is reversed, the short- or open-circuiting of any protective component, one component at a time, shall not result in forced discharge of the battery.
- 2) The end of the product shall contain a permanent marking adjacent to the battery stating the following: "Replace battery with (Battery manufacturer's name or end-product manufacturer's name), Part No. () only. Use of another battery may present a risk of fire or explosion. See owner's manual for safety instructions."
- 3) The instruction manual supplied with the end product shall also contain the above warning notice along with instructions to the user as to where replacement batteries can be obtained.

CAUTION: The battery used in this device may present a fire or chemical burn hazard if mistreated. "Do not disassemble, heat above 100 (212 ° F) or incinerate." "Dispose of used battery promptly. Keep away from children."

4) The following statements, or equivalent, shall be included on the smallest package containing replacement cells.

"CAUTION: Fire and burn hazard. Do not disassemble, heat above 212 ° F or incinerate. Keep battery out of reach of children and in original package until ready to use. Dispose of used batteries promptly."

Open Circuit Voltage Recovery After Short Circuit CR17335SE

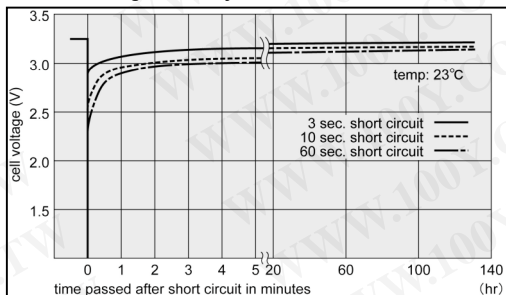

Allowable Charging Current Level When Diode Fails (UL Regulations)

Classification	Model	Max. allowable charging current (mA)	
Coin	CR1220	3.0	
	CR2016	10.0	
	CR2025	10.0	
	CR2032	10.0	
	CR2430	15.0	
	*CR2450	15.0	
cylindrical	high-power	CR-1/3N	2.0
		2CR-1/3N	2.0
		CR15270	20.0
		CR15400	25.0
		CR17335	25.0
		CR17335E-R	25.0
		CR17335HE-R	25.0
		CR17450E-R	25.0
		CR17450HE-R	25.0
	high-capacity	CR2	20.0
		CR123A	25.0
		CR-P2	25.0
		CR-V3	25.0
		2CR5	25.0
		*CR14250SE	10.0
		*CR12600SE	15.0
		*CR17335SE	15.0
		*CR17450SE	15.0
*CR23500SE	20.0		
*CR14250SE-R	10.0		
CR17335SE-R	15.0		
CR17450SE-R	15.0		
*CR23500SE-R	20.0		

[Rechargeable Lithium Batteries]

As part of our ongoing efforts to meet customers' needs, we offer a wide range of batteries featuring different terminals, as well as battery holders that facilitate easy connection to equipment. Only standard types of assembled batteries are discussed in this catalog. Consult Sanyo for details regarding terminals and other types of assembled batteries.

The ML2220, ML2020, ML2016, and ML1220 are not nickel-plated. Avoid bare-contact usage or contact between the battery holder and coin-type primary batteries. This could result in a faulty electrical connection. The battery must be used with connection terminals. However, the ML414, ML421, ML614, ML621, NBL414, and NBL621 are nickel-plated and allow bare-contact.

Standard specifications are described below. Consult Sanyo for further specifications.

Tab specification

Model	Capacity (mAh)	Insulating tube	Dimensions (mm)							Shape and material of terminal	Fig.
			A	B	C	D	E	F	G		
ML1220-TT2	15	yes	13	2	2.4	⊕ \ominus 3.0					Fig. 1
ML2016-TT2	30	yes	20.5	1.6	2	⊕ \ominus 3.0					
ML2020-TT2	45	yes	20.5	2	2.7	⊕ \ominus 3.0					
ML2430-TT2	100	yes	25	3	3.4	⊕ \ominus 3.0					
ML414R-TT30	0.1	no	4.8	1.4	1.8	1.1	1.3				Fig. 2
ML1220-HZ1	15	yes	13	2	2.4	6.3	5	10			Fig. 3
ML2016-HZ1	30	yes	20.5	1.6	2	6.3	5	18			
ML2430-HZ1	100	yes	25	3	3.4	6.3	5	18			
ML614-TZ14	3.4	no	6.8	1.4	1.8	2.6	⊕ \ominus 1.8	2.2			Fig. 4
ML414-TZ1	1.0	no	4.8	1.4	1.8	2.2	⊕ \ominus 1.6	1.5			
NBL414-TZ1	1.0	no	4.8	1.4	1.8	2.2	⊕ \ominus 1.6	1.5			Fig. 5
ML421-TZ1	2.3	no	4.8	2.1	26.5	2.2	⊕ \ominus 1.6	1.5			
ML621-TZ1	5.5	no	6.8	2.1	2.55	2.6	⊕ \ominus 2.0	1.5			
NBL621-TZ1	4.0	no	6.8	2.1	2.55	2.6	⊕ \ominus 2.0	1.5			Fig. 6
ML1220-TJ1	15	yes	13	2	2.8	3.1	⊕ \ominus 2.5	3.8			
ML1220-HJ1	15	yes	13	2	2.8	6.2	5	10	3.3		Fig. 7
ML2016-HJ1	30	yes	20.5	1.6	2.4	6.2	5	20.5			Fig. 8
ML2430-HJ1	100	yes	25	3	3.8	6.2	5	20.5			
ML1220-VM1	15	yes	13	2	4	7		3	2.7		Fig. 9
ML2016-VM1	30	yes	20.5	1.6	3.6	5		2.6	10.5		
ML2430-VM1	100	yes	25	3	5	5		4	10.5		
ML2016-HS1	30	yes	20.5	1.6	2.4	5.6	4	17.8	⊕ \ominus 0.2		Fig. 10
ML2430-HS1	100	yes	25	3	3.8	5.6	4	17.8	⊕ \ominus 0.2		
ML2016-VS1	30	yes	20.5	1.6	2.4	5	4	2.2	⊕ \ominus 0.2		Fig. 11
ML2430-VS1	100	yes	25	3	3.8	5	4	3.6	⊕ \ominus 0.2		

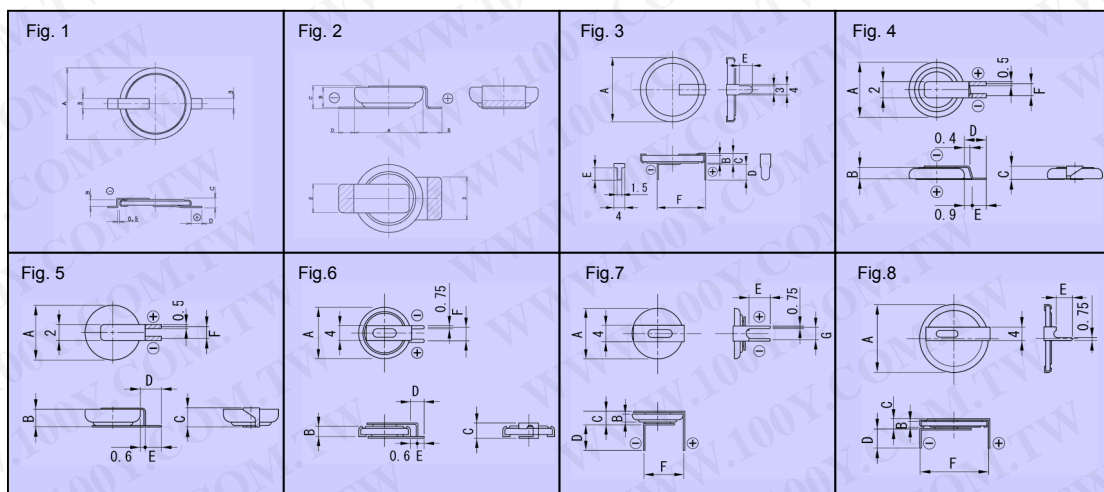

Stainless steel tab and nickel wire are solder plated.

勝特力材料 886-3-5753170
 勝特力电子(上海) 86-21-34970699
 勝特力电子(深圳) 86-755-83298787
[Http://www.100y.com.tw](http://www.100y.com.tw)

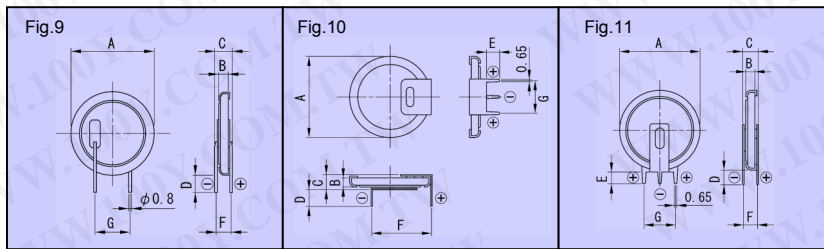

Assembled Rechargeable Lithium Batteries with Connectors

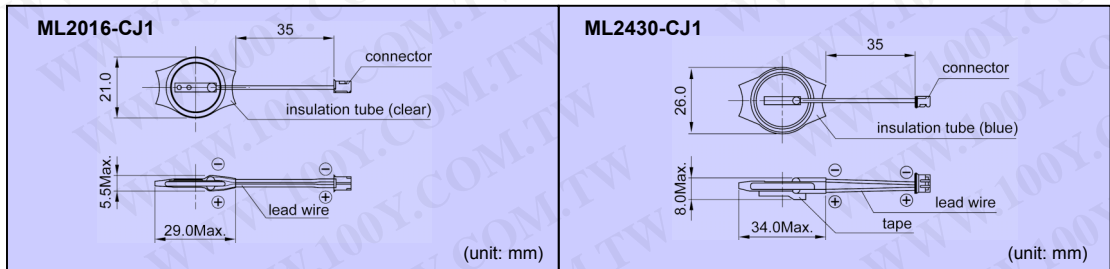

Battery Holders (For Rechargeable Lithium Batteries)

Surface Mounting Type

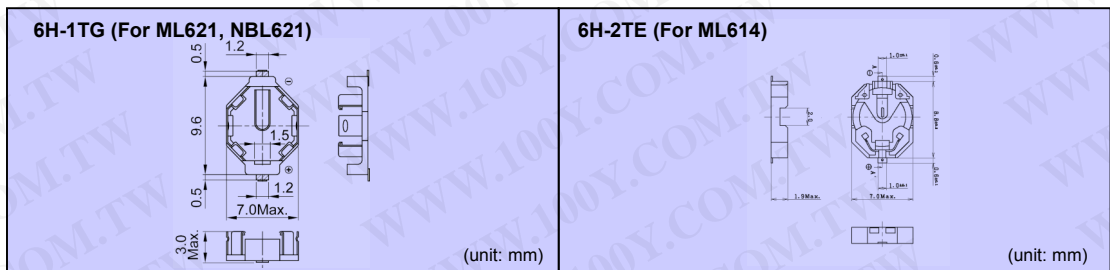

Features

- Easy battery replacement.
- Superior heat-resistant property allows reflowing.
(When mounting battery with a reflowing system, first solder a holder on PCB, then place the battery in it. Contact Sanyo for further details.)
- Compact and slim design requires minimal space.
- Rigid battery fixing.

Specifications

- Holder material is LCP and satisfies UL94V-0.
- For the terminal material, 0.1t of stainless steel plate is nickel-plated and gold-plated.
- The connection resistances of (+) and (-) terminals are under 100m Ω (1kHz through AC method).

勝特力材料 886-3-5753170
 勝特力电子(上海) 86-21-34970699
 勝特力电子(深圳) 86-755-83298787
[Http://www.100y.com.tw](http://www.100y.com.tw)

[Coin Type Rechargeable Lithium Batteries for Key Design Points of Circuits]

Selecting Batteries

Choose the best batteries to suit the equipment load current and expected durability. Sanyo generally ships batteries with approx. 90% charging condition. Handle with care to avoid short-circuiting. The relationship between load current and discharge time are shown below:

ML series

NBL series

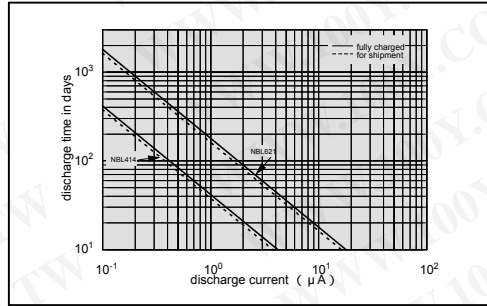
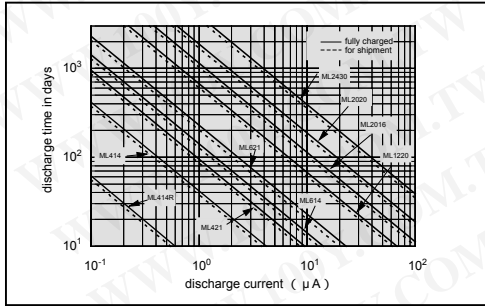

Important Points for Designing

Charging circuit of rechargeable lithium battery and Ni-Cd trickle charging circuit are different. When a rechargeable lithium battery is charged with a Ni-Cd trickle charging circuit, over-voltage may occur, resulting in deterioration of battery performance, leakage and corrosion. The following steps must be taken to make full use of the superior features of rechargeable lithium batteries.

Charge Circuit of Rechargeable Lithium Batteries

A constant voltage charging system is recommended for rechargeable lithium batteries. Sample cases for a constant voltage charge are shown as follows. Contact Sanyo for details regarding circuit design.

Constant Voltage Charge System

ML series	NBL series
3.10 ± 0.15V	2.20 ± 0.4V
2.95 ± 0.15V	2.10 ± 0.3V
at cell voltage 2.8V. ML414, ML414R : under 0.2mA ML614, ML621: under 0.45mA ML1220: under 2.25mA ML2016, ML2020, ML2430: under 4.5mA	at cell voltage 1.5V. NBL414 : under 0.2mA NBL414, NBL621: under 0.35mA

Circuit examples when charging with a 5V line

(1) Charge/discharge control IC use

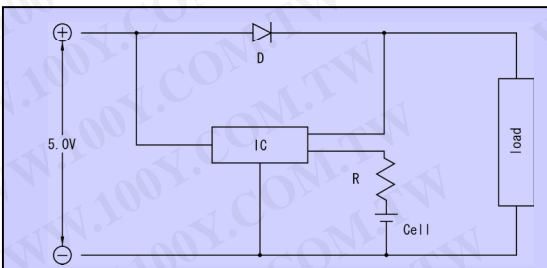

This IC controls charge voltage and has an overdischarge protection circuit.

D: silicon or Schottky diode
IC: charge/discharge control IC (MB3790, or equivalent)
R: charge current control resistor
Cell: rechargeable lithium battery (ML)

勝特力材料 886-3-5753170
勝特力电子(上海) 86-21-34970699
勝特力电子(深圳) 86-755-83298787
[Http://www.100y.com.tw](http://www.100y.com.tw)

(2) Voltage regulator IC use

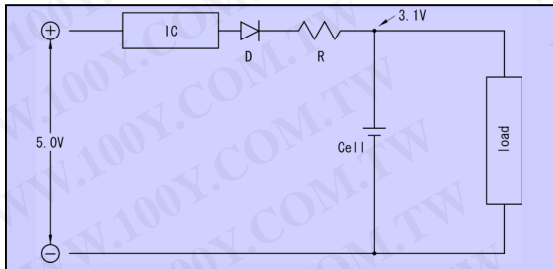

The voltage regulator IC is used for control charge voltage. This circuit can prevent the voltage drop of the battery by resistance at discharge.

D: silicon or Schottky diode
 IC: voltage regulator IC (S-81232, or equivalent)
 R: charge current control resistor
 Cell: rechargeable lithium battery (ML)

(3) Zener diode (ZD) use

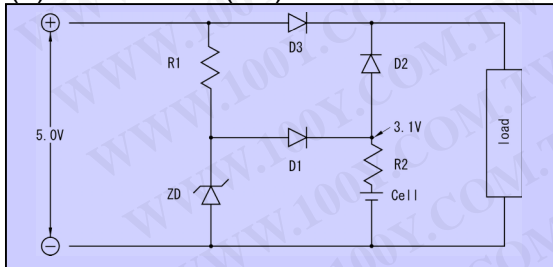

The zener diode is used for control charge voltage.

D1: silicon or Schottky diode
 D2: silicon or Schottky diode
 (use diode with under 0.1 μ A reverse current at 2.0V reverse voltage.)
 D3: silicon or Schottky diode
 R1: charge voltage, charge current control resistor
 R2: charge current control resistor
 ZD: Zener diode
 Cell: rechargeable lithium battery (ML)

Notice:

As shown in circuit example (3), if there is a possibility that the battery might be charged by D2 reverse current, choose a diode having reverse current below 0.1 μ A when the reverse voltage of D2 is 3V. Be aware that the higher the temperature rises, the larger the D2 reverse current becomes. Using an ML614 and ML621 in the circuit (3), however, is NOT recommended.

Examples of actual circuit (3) are shown on the right. The model numbers of diodes described here are just examples.

When applying for the UL standards, carefully observe the following charge current values (when a protective part has been shorted or opened):

ML414, ML414R, ML421, ML614: 56mA or below
 ML621, ML1220, ML2016, ML2020, ML2430: 300mA or below

Charging lime:

Hours required to fully charge a battery, after discharged to a 2.0V end voltage.

Variations of battery voltage and charge capacity are shown below.

	example (1)	example (2)	example (3)
D1	Sanyo SB0203C	Sanyo SB00703Q	
D2, D3	Sanyo SB00703Q		
ZD	Sanyo GZA3.3X	Sanyo GZA3.6X	Sanyo GZA3.9Z
R1	180 Ω (R2 = 0 Ω)	820 Ω (R2 = 0 Ω)	3.9k Ω (R2 = 0 Ω)
Cell	ML2016		
Charging time	approx. 20hr	approx. 50hr	approx. 130hr

Charging time : Hours required to fully charge a battery, after discharged to a 2.0V end voltage.

Variations of battery voltage and charge capacity are shown on the next page.

The smaller the R value, the shorter the time required to fully charge. However, considering charge, efficiency, battery deterioration and circuit components, set the R value as shown in the table.

	ML1220	ML2016	ML2430
Value of R1	over 360 Ω	over 180 Ω	over 180 Ω

Charge Time vs. Cell Voltage

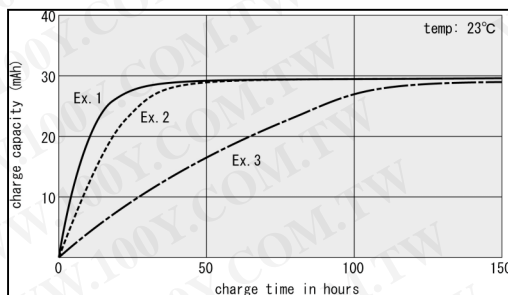

Charge Time vs. Cell Capacity

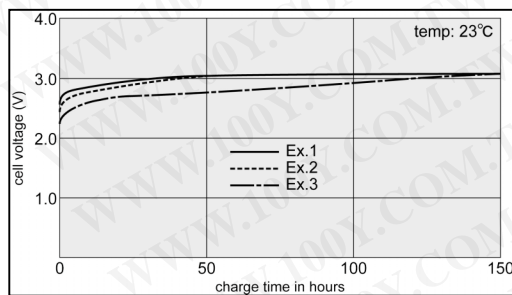

Circuits (1) and (2) are recommended when using solar batteries as the main power source.

勝特力材料 886-3-5753170
 勝特力电子(上海) 86-21-34970699
 勝特力电子(深圳) 86-755-83298787
[Http://www.100y.com.tw](http://www.100y.com.tw)

(1) Voltage regulator IC use

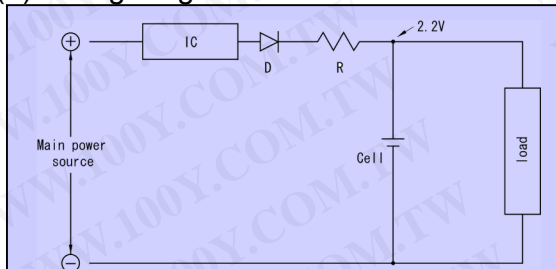

The voltage regulator IC is used for control charge voltage. This circuit can prevent the voltage drop of the battery by resistance at discharge.

D: silicon or Schottky diode
 IC: voltage regulator IC
 R: charge current control resistor
 Cell: rechargeable lithium battery (NBL)

The above circuit is also recommended when using a solar battery as the main power source.

Charge Voltage of Batteries

Set the charging voltage of the battery at 2.8 ~ 3.25V for the ML-series and 1.8 ~ 2.6V for the NBL-series. Design the circuit with as low a voltage as possible.

When charging the battery at a high temperature for a long time, the charging voltage should be set at 2.8 ~ 3.1V for the ML-series and 1.8 ~ 2.4V for the NBL-series.

If charged with a higher voltage than these normal conditions, the internal impedance will increase, causing a number of problems including battery performance deterioration, swelling and leakage.

Constant Current Charge

When charged with a constant current, design the circuit so that the cell voltage does not exceed upper limit of voltage range. The charging current differs by the battery model. Consult Sanyo for details.

Overdischarge

Lithium rechargeable batteries suffer deterioration in performance when overdischarged for a long period, or when they are frequently overdischarged. Deterioration is especially severe when overdischarged at high temperatures. Mounting an overdischarge prevention circuit is recommended when overdischarge occurs frequently or for a long period, or when the temperature is high.

Maximum Charge Current of Batteries

According to UL directives, even if there is a problem into the circuit components, the charge current in the battery should not exceed Max. charge current below.

ML2430, ML2020, ML2016, ML1220, ML621: Max.300mA

ML614, ML414, ML414R: Max.56mA

NBL621, NBL414: 15mA

Consult Sanyo for details.

Series and Parallel Use of Batteries

Be sure to contact Sanyo when batteries are used in series or parallel.

Placement of Batteries

When the battery is placed close to components that generate heat, the battery may become hot. This may cause deformation of the packing material, resulting in leakage and inferior performance.

Cleaning and Drying

The use of a solvent with electrical conducting properties may cause the battery to short circuit, resulting in the deterioration of the battery's performance. If the temperature rises above 85 when drying, the gasket becomes thermally deformed. This may cause leakage or inferior battery performance. Be sure not exceed 85 when drying.

Storage of Batteries

Store batteries in a dry place that is not exposed to direct sunlight and has little temperature fluctuation. Storage at high temperatures or high humidity may influence the battery's performance.

Recommended storage conditions:

temperature : 10 to 30

relative humidity : under 60%

Soldering

When soldering is required, use a battery equipped with a connection terminal. Do not apply solder directly to the battery.

Hand soldering should be done as quickly as possible (within 5 seconds) at a temperature from 250 to 350 .

If too much solder is used, solder may flow under the battery onto the PC board, causing battery leakage or deterioration of battery characteristics.

Be especially careful when the battery and PC board are positioned close together.

Apply at 250 ~ 270 within 5 seconds. If the battery is kept above the soldering bath for a long time, or if it is dropped into the soldering bath, it may burst open due to overheating. To avoid leakage due to thermal deformation of the gasket material or deterioration of battery performance, make sure that the battery temperature does not exceed 85 . Consult Sanyo for details when soldering is applied with reflowing system. The graph shows open circuit voltage recovery characteristics after a presumed short circuit during automatic soldering.

Open Circuit Voltage Recovery After Short Circuit ML2430

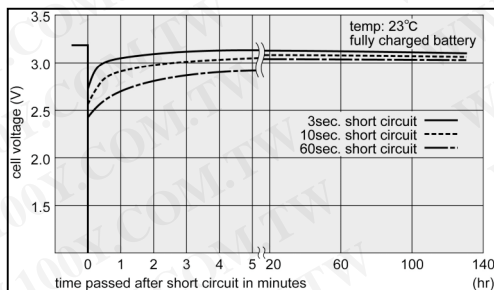

Open Circuit Voltage Recovery After Short Circuit NBL621

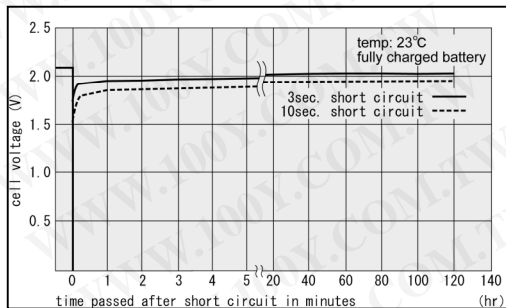

勝特力材料 886-3-5753170

勝特力电子(上海) 86-21-34970699

勝特力电子(深圳) 86-755-83298787

Http://www.100y.com.tw

[Battery Selection Guide]

When choosing batteries, the rating of the device, operating load conditions, and operating temperature range should be considered.
 Main technical factors are shown below.
 Lithium battery characteristics depend on load and operating conditions.
 Please consult SANYO for further details or inquiries.

Technical factors regarding battery selection (reference)

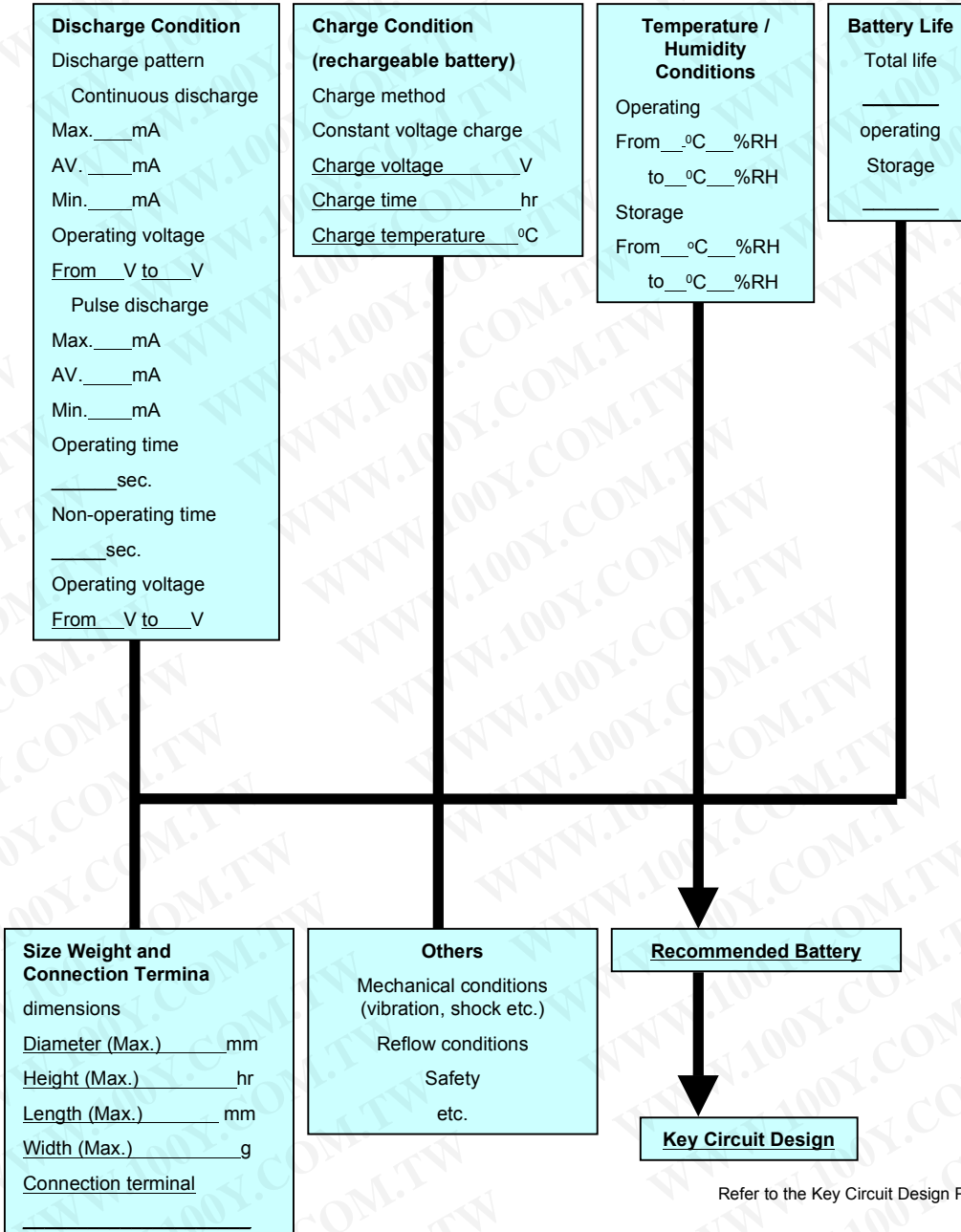

[Battery Handling Precautions for Your Own Safety]

Lithium batteries contain combustible materials such as lithium metal and organic solvent. Improper handling can lead to heat generation, bursting or fire. To prevent accidents, follow these precautions and refer to them when precautions regarding lithium battery usage are described in instruction manuals for equipment you are using.

Coin-type Primary and Rechargeable Lithium Batteries

Warning!

1. Do not charge. (Primary batteries, CR series).

When this battery is charged, gas is generated inside and raises internal pressure, resulting in fire, heat generation, leakage or bursting.

2. Do not heat, disassemble nor dispose of in fire.

Doing so damages the insulation materials or the safety vent, resulting in fire, heat generation, leakage or bursting.

3. Do not insert batteries with the ⊕ and ⊖ polarities reversed.

Make sure the polarities are in the right position when inserting the batteries into equipment. When using 3 or more batteries, the equipment may operate even though one of the batteries is improperly inserted. But this may cause leakage or bursting.

4. Do not short-circuit.

If the ⊕ and ⊖ come into contact with metal objects, short circuiting occurs resulting in heat generation or bursting. When carrying or storing batteries, avoid direct contact with metal objects such as bracelets or key chains by putting them in a separate bag.

5. Keep batteries out of children's reach.

If leaked liquid is ingested or a battery is swallowed, consult a physician immediately.

6. In case of leakage or a strange smell, keep away from fire to prevent ignition of any leaked electrolyte.

7. Do not solder directly.

This can damage the insulation materials, resulting in fire, heat generation, leakage or bursting.

8. Be sure to wrap each battery when disposing or storing to avoid short circuit

Putting batteries together or in contact with metal objects causes short circuiting, resulting in fire, heat generation or bursting.

9. Do not force-discharge.

When a battery is force-discharged by an external power source, the voltage drops to 0 or less (reversal voltage) and gas is generated inside the battery. This may cause fire, heat generation, leakage or bursting.

10. Do not charge with high current and high voltage. (Rechargeable batteries, ML, NBL series).

Doing so may generate gas inside the battery, resulting in swelling, fire, heat generation or bursting.

Caution!

1. If leaked liquid gets in the eyes, wash them with clean water and consult a physician immediately.

2. Do not use new and used batteries together. Do not use different types of batteries together.

Doing so may cause heat generation, leakage or bursting.

3. Do not apply strong pressure to the batteries nor handle roughly.

Doing so may cause heat generation, leakage or bursting.

4. Do not use nor leave the batteries in direct sunlight nor in high-temperature areas.

Doing so may cause heat generation, leakage or bursting.

5. Avoid contact with water.

Doing so may cause heat generation.

6. Make sure to insert batteries without having the ⊕ and ⊖ come in contact with metal parts of equipment.

7. Read the equipment instruction manual and precautions carefully before use.

Some usages or types of equipment do not suit the specifications or performance of these batteries.

8. Keep batteries away from direct sunlight, high temperature and humidity.

Leaving batteries in such places may cause heat generation.

9. For proper disposal, follow local government regulations.

勝特力材料 886-3-5753170
勝特力电子(上海) 86-21-34970699
勝特力电子(深圳) 86-755-83298787
[Http://www.100y.com.tw](http://www.100y.com.tw)

Cylindrical-type Primary Lithium Batteries



Warning!

DO NOT CHARGE

1. Do not use batteries for unspecified purposes.

Differences in voltage or terminal configuration may cause an imperfect connection, fire, heat generation, leakage or bursting.

2. Do not charge.

When this battery is charged, gas is generated inside and raises internal pressure, resulting in fire, heat generation, leakage or bursting.

3. Do not heat, disassemble nor dispose of in fire.

Doing so damages the insulation materials or the safety vent, resulting in fire, heat generation, leakage or bursting.

4. Do not insert batteries with the ⊕ and ⊖ polarities reversed.

Make sure the polarities are in the right position when inserting the batteries into equipment. When using 3 or more batteries, the equipment may operate even though one of the batteries is improperly inserted. But this may cause leakage or bursting.

5. Do not short-circuit.

If the ⊕ and ⊖ come into contact with metal objects, short circuiting occurs resulting in heat generation or bursting. When carrying or storing batteries, avoid direct contact with metal objects such as bracelets or key chains by putting them in a separate bag.

6. Keep batteries out of children's reach.

If leaked liquid is ingested or a battery is swallowed, consult a physician immediately.

7. In case of leakage or a strange smell, keep away from fire to prevent ignition of any leaked electrolyte.

8. Do not use new and used batteries together. Do not use different types of batteries together.

Doing so may cause fire, heat generation, leakage or bursting.

9. Do not solder directly.

Doing so may cause damage to insulation materials. It may also cause fire, heat generation, leakage or bursting.

10. Do not apply strong pressure nor handle roughly.

Doing so may cause fire, heat generation, leakage or bursting.

11. To prevent damage to the safety vent inside the battery, do not deform in any way.

12. Do not force-discharge.

When a battery is force-discharged by an external power source, the voltage drops to 0 or less (reversal voltage) and gas is generated inside the battery. This may cause fire, heat generation, leakage or bursting.

13. Do not damage nor peel off the resin film on the surface of the battery.

The battery surface is covered with thin vinyl film to prevent short circuiting. Cutting with a knife or peeling off this film causes short circuiting, resulting in heat generation or bursting.



Caution!

1. If leaked liquid gets in the eyes, wash them with clean water and consult a physician immediately.

2. Do not use nor leave the batteries in direct sunlight nor in high-temperature areas.

Doing so may cause heat generation, leakage or bursting.

3. Avoid contact with water.

This can cause heat generation.

4. Read the equipment instruction manual and precautions carefully before use. Some usages or types of equipment do not suit the specifications or performance of these batteries.

5. Keep batteries away from direct sunlight, high temperature and humidity.

Leaving batteries in such places may cause heat generation.

6. Be sure to wrap each battery when disposing or storing to avoid short circuit.

Putting batteries together or in contact with metal objects causes short circuiting, resulting in fire, heat generation or bursting.

7. For disposal, follow local government regulations.

勝特力材料 886-3-5753170
勝特力电子(上海) 86-21-34970699
勝特力电子(深圳) 86-755-83298787
[Http://www.100y.com.tw](http://www.100y.com.tw)

[Precautions for Designing Equipment]

As specified in these Battery Handling Precautions for Your Own Safety, improper handling of lithium batteries can lead to overheating, bursting or fire. To prevent accidents, carefully observe the following precautions when designing equipment.

Primary Lithium Batteries [for main power source]

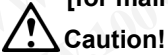

Caution!

1. Select appropriate batteries for specific uses.

To obtain maximum battery performance, be sure to select an appropriate battery to meet the load, current, expected durability and other equipment operating conditions. Improper selection may generate excessive current flow, which in turn can cause heat generation, fire or bursting, resulting in damage to the equipment. Consult SANYO for details.

2. Observe the following precautions when using two or more batteries in series or in parallel.

Do not connect more than three cells in series. Do not use more than one assembled battery pack (including 2CR5, CR-P2 and 2CR-1/3N). When connecting batteries in parallel, be sure to mount a diode between the batteries.

When using two or more batteries, the equipment must be designed so that the lithium battery will not be used together with other batteries of different capacity, type or brand. Consult SANYO when incorporating two or more batteries into the equipment.

If different types of batteries are used together, the difference in voltage, capacity, etc. may cause overdischarge of a battery with inferior characteristics, resulting in heat generation, fire, bursting or combustion.

If different types of batteries are used in parallel, the batteries with inferior characteristics may be charged by the other batteries, resulting in heat generation, fire, bursting or combustion.

3. Use an independent power circuit for the battery.

If equipment is designed with a dual or triple power source system where the lithium battery is combined with other battery types or an AC power source, an independent circuit must be provided to prevent the lithium battery from forced charge or discharge by other power sources in use.

4. Incorporate maximum current protection devices.

To avoid excessive current flow due to an equipment circuit malfunction, incorporate appropriate protective devices such as a thermal fuse, resistor and PTC device that meet specific usage conditions.

If excessive current flows from the battery due to an equipment circuit malfunction, the circuit or equipment may be damaged. It also may cause heat generation, fire, bursting or combustion.

[When using as auxiliary power source for memory backup]

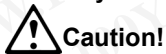

Caution!

1. Use an independent circuit for batteries.

To prevent lithium batteries from forced charge or discharge by the main power source, use an independent circuit wherever possible.

2. Observe the following precautions when connecting to a separate main power source.

If there is any possibility that electric current might flow from the separate main power source to charge the battery, use a diode and protective resistor in combination. For details, refer to the Primary Lithium Batteries for Memory Backup & Key Design Points, pages 5 and 6.

Rechargeable Lithium Batteries



Caution!

1. Consult SANYO when using two or more batteries in series or in parallel.

2. Observe the charging conditions (voltage and current).

Refer to the Rechargeable Lithium Batteries for Memory Backup - Key Design Points for, pages 9 to 11.

Battery Holder and Compartment Structures



Caution!

1. Take special care when designing battery holders and compartments.

A SANYO special battery holder is recommended.

The battery holder must be constructed so that the positive and negative terminals of the battery cannot be reversed. Be especially careful when using two or more batteries. The correct battery placement direction (positive and negative polarity indications) and installation instructions must be marked clearly and permanently on the holder.

The battery holder must be constructed to prevent mixed use with other batteries of different characteristics including voltage and type of battery.

The battery compartment must be provided with a gas release structure. For use with equipment of water-resistant construction, or if there is any possibility of exposure to water, the compartment must include features to prevent water from entering (such as a waterproofing or dip-proof design).

If the battery compartment is airtight, it must have an explosion-proof structure such as an explosion-proof vent or thin wall area for emergency venting. If the equipment has any heat source, the compartment must either be located away from the heat source preventing the battery from exposure to heat or be constructed to resist heat.

The battery compartment must be constructed so that batteries cannot be easily removed by small children.

If the positive and negative terminals of a battery are reversed (when two or more batteries are used), the improperly inserted battery may be charged, resulting in heat, fire, bursting or combustion.

If gas is generated within an airtight battery compartment, its internal pressure will rise, causing compartment explosion. If water enters into the compartment, it may cause electrolysis in the battery, generating gas and causing an excessive rise in internal pressure which is hazardous. To prevent equipment from exploding, an airtight compartment must include an explosion-proof structure such as a thin wall area for emergency venting.

Precautions for Contacts and Terminals



Caution!

Be extremely careful to select contact materials and shapes that provide sufficient electrical contact.

Avoid electrical contact with areas on the battery and circuit except for designated contact points.

The contacts must be constructed to prevent the reversal of the positive and negative terminals, thus taking the battery structure and difference in the shapes of positive and negative terminals into consideration.

Do not directly apply solder to the battery terminals. inappropriate contact and/or terminal shapes may cause inferior contact, resulting in heat generation or short circuiting.

勝特力材料 886-3-5753170

勝特力电子(上海) 86-21-34970699

勝特力电子(深圳) 86-755-83298787

[Http://www.100y.com.tw](http://www.100y.com.tw)