

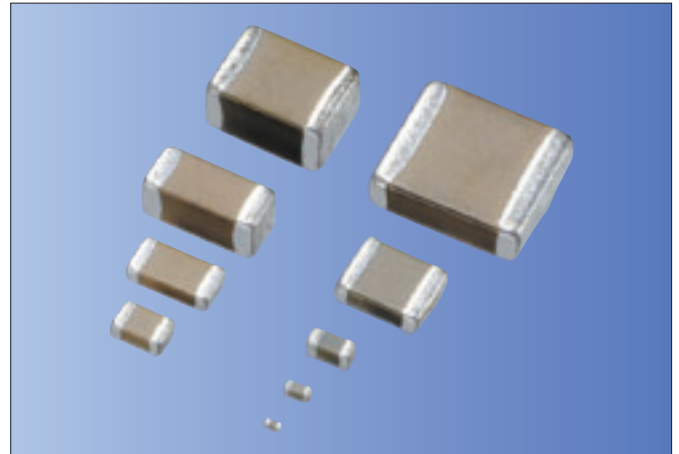

Kyocera's series of Multilayer Ceramic Chip Capacitors are designed to meet a wide variety of needs. We offer a complete range of products for both general and specialized applications, including CM series for general-purpose, CT series for low profile, CU series for Hi-Q, AT series for Au termination, ST series for soft termination, and CF series for high-voltage.

Features

- We have a network worldwide in order to supply our global customer bases quickly and efficiently and to maintain our reputation as one of the highest-volume producers in the industry.
- All our products are highly reliable due to their monolithic structure of high-purity and superfine uniform ceramics and their integral internal electrodes.
- By combining superior manufacturing technology and materials with high dielectric constants, we produce extremely compact components with exceptional specifications.
- Our stringent quality control in every phase of production from material procurement to shipping ensures consistent manufacturing and super quality.
- Kyocera components are available in a wide choice of dimensions, temperature characteristics, rated voltages, and terminations to meet specific configurational requirements.



RoHS Compliant

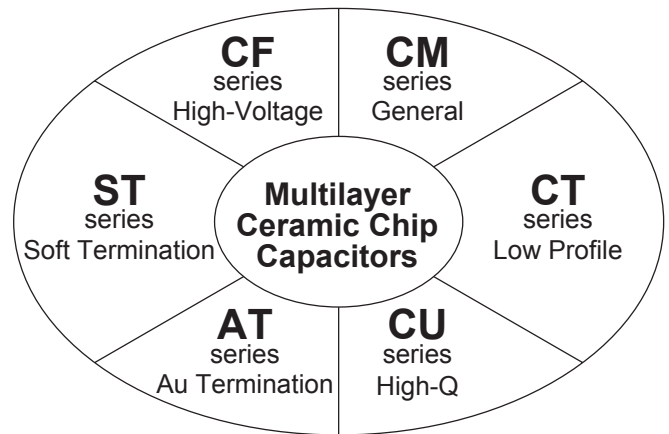

Structure

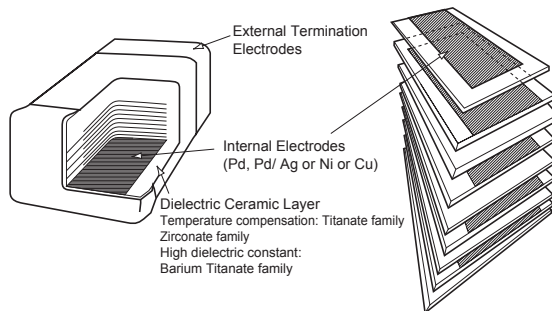

Nickel Barrier Termination Products

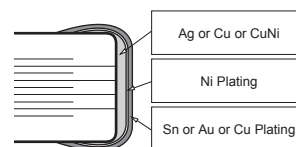

Tape and Reel

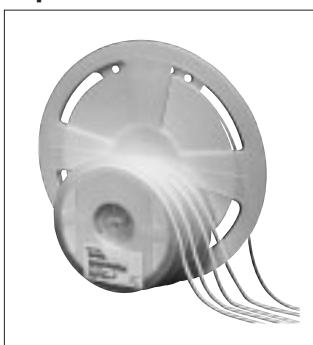

Bulk Case



Please contact your local AVX, Kyocera sales office or distributor for specifications not covered in this catalog.

Our products are continually being improved. As a result, the capacitance range of each series is subject to change without notice. Please contact an sales representative to confirm compatibility with your application.



Kyocera Ceramic Chip Capacitors are available for different applications as classified below:

Series	Dielectric Options	Typical Applications	Features	Terminations	Available Size
CM	C0G (NP0) X5R X7R *X6S X7S	General purpose	Wide cap range	Nickel barrier/ Tin	01005, 0201, 0402 0603, 0805, 1206 1210, 1812
CT	X5R X7R	IC card (Decoupling)	Low profile	Nickel barrier/ Tin	0201, 0402, 0603 0805, 1206, 1210
CU	C0G (NP0)	Power amplifier	High-Q	Nickel barrier/ Tin	01005
AT	X5R X7R	Optical communications	Au termination	Nickel barrier/ Au	0201, 0402
ST	X5R X7R X7S	PCB with severe bending conditions	Soft termination	Nickel barrier/ Tin (Soft Termination)	0201, 0402 1206, 1210
CF	C0G (NP0) X7R	High voltage & Power circuits	High voltage 250VDC, 630VDC 1000VDC, 2000VDC 3000VDC, 4000VDC	Nickel barrier/ Tin	0805, 1206, 1210 1808, 1812, 2208 2220

* Option

* Negative temperature coefficient dielectric types are available on request.



Dimensions

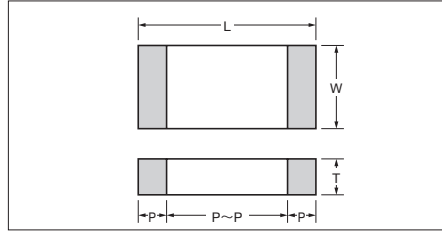

※Packaging Code

(E 8 / 2)

Taping Material		Taping Width		Pitch	
Code	Material	Code	Width	Code	Pitch
E	Plastic	4	4mm	1	1mm
P	Paper	8	8mm	2	2mm
		12	12mm	4	4mm
				8	8mm

Dimensions and Packaging Quantities

Size	Code		Dimension Code	Dimensions (mm)					Maximum quantity per reel								
	JIS	EIA		L	W	T	P min.	P max.	P to P min.	φ180 Reel*	φ330 Reel*						
02	0402	01005	A	0.4±0.02	0.2±0.02	0.2±0.02	0.07	0.14	0.13	40kp (E4/1) 20kp (P8/2)	-						
			B	0.6±0.03	0.3±0.03	0.22 max. 0.3±0.03	0.10	0.20	0.20	30kp (P8/1) 15kp (P8/2)	150kp (P8/1) 50kp (P8/2)						
03	0603	0201	C	0.6±0.05	0.3±0.05	0.3±0.05	0.13	0.23	0.19	30kp (P8/1) 15kp (P8/2)	150kp (P8/1) 50kp (P8/2)						
			D	0.6±0.09	0.3±0.09	0.3±0.09	0.13	0.23	0.19	15kp (P8/2)	-						
			E	0.6±0.10	0.3±0.10	0.25 max. 0.3±0.10				15kp (P8/2)	-						
			F	0.6±0.10	0.3±0.10	0.3±0.10	15kp (P8/2)	-									
			A	1.0±0.05	0.5±0.05	0.22 max.	0.15	0.35	0.30	20kp (P8/1) 10kp (P8/2)	100kp (P8/1) 50kp (P8/2)						
			B			0.25 max.				20kp (P8/1) 10kp (P8/2)	100kp (P8/1) 50kp (P8/2)						
05	1005	0402	C	1.0±0.07	0.5±0.07	0.33 max.	0.15	0.35	0.30	20kp (P8/1) 10kp (P8/2)	100kp (P8/1) 50kp (P8/2)						
			D			0.35 max.				20kp (P8/1) 10kp (P8/2)	100kp (P8/1) 50kp (P8/2)						
			E	1.0±0.10	0.5±0.10	0.5±0.05	0.15	0.35	0.30	20kp (P8/1) 10kp (P8/2)	100kp (P8/1) 50kp (P8/2)						
			F			1.0±0.07				0.5±0.07	0.5±0.07	20kp (P8/1) 10kp (P8/2)	100kp (P8/1) 50kp (P8/2)				
			G	1.0±0.15	0.5±0.15	0.35 max.	0.15	0.35	0.30	20kp (P8/1) 10kp (P8/2)	100kp (P8/1) 50kp (P8/2)						
			H			0.5±0.10				20kp (P8/1) 10kp (P8/2)	100kp (P8/1) 50kp (P8/2)						
			105	1608	0603	J	1.6±0.10	0.8±0.10	0.5±0.15	0.20	0.60	0.50	20kp (P8/1) 10kp (P8/2)	100kp (P8/1) 50kp (P8/2)			
						K			0.33 max. 0.5±0.20				20kp (P8/1) 10kp (P8/2)	100kp (P8/1) 50kp (P8/2)			
						L	1.6±0.15	0.8±0.15	0.55 max.	0.20	0.60	0.50	4kp (P8/4) 8kp (P8/2)	10kp (P8/4) 20kp (P8/2)			
						A			0.55 max.				4kp (P8/4) 8kp (P8/2)	10kp (P8/4) 20kp (P8/2)			
B	1.6±0.20	0.8±0.20				0.8±0.10	0.20	0.60	0.50	4kp (P8/4) 8kp (P8/2)	10kp (P8/4) 20kp (P8/2)						
C						0.8±0.15				4kp (P8/4) 8kp (P8/2)	10kp (P8/4) 20kp (P8/2)						
21	2012	0805				D	2.0±0.10	1.25±0.10	0.55 max.	0.20	0.75	0.70	4kp (P8/4) 8kp (P8/2)	10kp (P8/4) 20kp (P8/2)			
						E			0.8±0.20				4kp (P8/4) 8kp (P8/2)	10kp (P8/4) 20kp (P8/2)			
						F	2.0±0.15	1.25±0.15	0.85±0.10 1.05±0.10	0.20	0.75	0.70	4kp (P8/4) 3kp (E8/4)	10kp (P8/4) 10kp (E8/4)			
						G			1.25±0.10				4kp (P8/4) 3kp (E8/4)	10kp (P8/4) 10kp (E8/4)			
			H	2.0±0.20	1.25±0.20	0.55 max. 0.95 max.	0.20	0.75	0.70	4kp (P8/4) 3kp (E8/4)	10kp (P8/4) 10kp (E8/4)						
			J			1.25±0.15 0.95 max.				4kp (P8/4) 3kp (E8/4)	10kp (P8/4) 10kp (E8/4)						
			316	3216	1206	K	3.2±0.20	1.6±0.15	1.25±0.20 0.95 max.	0.30	0.85	1.40	4kp (P8/4) 3kp (E8/4)	10kp (P8/4) 10kp (E8/4)			
						L			1.15±0.10 1.25±0.10				4kp (P8/4) 3kp (E8/4)	10kp (P8/4) 10kp (E8/4)			
						M	3.2±0.20	1.6±0.20	1.6±0.15 0.95 max.	0.30	0.85	1.40	2.5kp (E8/4) 4kp (P8/4)	5kp (E8/4) 10kp (P8/4)			
						A			1.00 max. 1.6±0.20				4kp (P8/4) 2.5kp (E8/4)	10kp (P8/4) 5kp (E8/4)			
						B	3.2±0.30	1.6±0.30	1.6±0.20	0.30	0.85	1.90	2.5kp (E8/4) 2kp (E8/4)	5kp (E8/4) -			
						C			1.6±0.30				2kp (E8/4) 1kp (E8/4)	4kp (E8/4) -			
						32	3225	1210	D	4.5±0.20	2.5±0.20	1.00 max. 1.40 max.	0.30	1.00	1.40	4kp (E8/4) 3kp (E8/4)	10kp (E8/4) 10kp (E8/4)
									E			1.60 max. 1.6±0.15				2.5kp (E8/4) 2.5kp (E8/4)	5kp (E8/4) 5kp (E8/4)
F	4.5±0.30	3.2±0.20							2.20 max. 2.0±0.2	0.30	1.10	2.00	2kp (E8/4) 2kp (E8/4)	5kp (E8/4) 5kp (E8/4)			
G									2.5±0.2				1kp (E8/4) 2kp (E12/4)	4kp (E8/4) -			
42	4520	1808	A	4.5±0.30	3.2±0.20				1.6 max. 2.2 max.	0.30	1.10	2.00	2kp (E12/4) 2kp (E12/4)	- -			
			B						2.0 max. 2.0±0.2				1kp (E12/8) 1kp (E12/8)	- -			
			C	2.5 max. 2.5±0.2	0.5kp (E12/8) 0.5kp (E12/8)				- -								
52	5720	2208	D	5.7±0.40	2.0±0.20	2.8±0.2	0.15	0.85	4.20	0.5kp (E12/8)	-						
			E			2.2 max. 2.0 max.				2kp (E12/4) 1kp (E12/8)	- -						
55	5750	2220	A	5.7±0.40	5.0±0.40	2.5 max. 2.8 max.	0.30	1.40	2.50	0.5kp (E12/8) 0.5kp (E12/8)	- -						
			B			2.0 max. 2.5 max.				1kp (E12/8) 0.5kp (E12/8)	- -						
			C	2.8 max.	0.5kp (E12/8)	-											

Note: Taping denotes the quantity packaged per reel (kp means 1000 pieces). * Please contact us.



Temperature Compensation Type

Code	ppm/ °C		Temperature Range
CG	0	±30	-55 to 125°C
CH		±60	

Note: All parts of COG will be marked as "CG" but will conform to the above table.
Temperature coefficients are determined by calculation based on measurement at 20°C and 85°C.

High Dielectric Constant Type

EIA Dielectric	Temperature Range	ΔC max.
X5R	-55 to 85°C	±15%
X7R	-55 to 125°C	
X7S	-55 to 125°C	±22%
*X6S	-55 to 105°C	

* option

Available Tolerances

Dielectric materials, capacitance values and tolerances are available in the following combinations only:

EIA Dielectric	Tolerance	Capacitance
C0G	*3 A=±0.05pF	<0.5pF
	B=±0.1pF	≤5pF
	C=±0.25pF	*1 <10pF
	D=±0.50pF	
*3 X6S X5R X7S X7R	*3 G=±2%	≥10pF E12 Series
	J=±5%	
	K=±10%	
*3 X6S X5R X7S X7R	*2 K=±10%	*4 E3 Series
	M=±20%	

Note:

*1 Nominal values below 10pF are available in the standard values of 0.5pF, 1.0pF, 1.5pF, 2.0pF, 3.0pF, 4.0pF, 5.0pF, 6.0pF, 7.0pF, 8.0pF, 9.0pF

*2 J = ±5% for X7R (X5R) is available on request.

*3 option

*4 E6 series is available on request.

E Standard Number

E3	E6	E12	E24 (Option)	
1.0	1.0	1.0	1.0	1.1
		1.2	1.2	1.3
	1.5	1.5	1.5	1.6
		1.8	1.8	2.0
2.2	2.2	2.2	2.2	2.4
		2.7	2.7	3.0
	3.3	3.3	3.3	3.6
		3.9	3.9	4.3
4.7	4.7	4.7	4.7	5.1
		5.6	5.6	6.2
	6.8	6.8	6.8	7.5
		8.2	8.2	9.1

Features

We offer a diverse product line ranging from ultra-compact (0.4×0.2mm) to large (4.5×3.2mm) components configured for a variety of temperature characteristics, rated voltages, and packages. We offer the choice and flexibility for almost any applications.

Applications

This standard type is ideal for use in a wide range of applications, from commercial to industrial equipment.

Temperature Compensation Dielectric

Size (EIA Code)	CM02 (01005)		CM03 (0201)		CM05 (0402)	CM105 (0603)	CM21 (0805)		
Temperature	CΔ*1		CΔ*1		CΔ*1	CΔ*1	CΔ*1		
Rated Voltage (VDC)	16		25		50	50	16		
Capacitance (pF)	25		50		50	50	50		
R20									
R50									
1R0									
1R5									
2.0									
3.0									
4.0									
5.0									
6.0									
7.0									
8.0									
9.0									
100									
120									
15									
18									
22									
27									
33									
39									
47									
56									
68									
82									
101									
121									
120									
150									
180									
220									
270									
330									
390									
470									
560									
680									
820									
102									
122									
1200									
1500									
1800									
2200									
2700									
3300									
3900									
4700									
5600									
6800									
8200									
103									
123									
12000									
15000									
18000									

<Standard Capacitance Value>

E12 Series

Please contact for capacitance value other than standard.

*1: CG,CH

Alphabets in capacitance chart denote dimensions.

Please refer to the below table for detail.

(Example)

In case of "B" for CM03;

L : 0.6±0.03mm

W : 0.3±0.03mm

T : 0.3±0.03mm

Size	Size Code	Dimension (mm)		
		L	W	T
02	A	0.4±0.02	0.2±0.02	0.2±0.02
03	B	0.6±0.03	0.3±0.03	0.3±0.03
05	E	1.0±0.05	0.5±0.05	0.5±0.05
105	B	1.6±0.10	0.8±0.10	0.8±0.10
21	E	2.0±0.10	1.25±0.10	0.85±0.10
	G	2.0±0.10	1.25±0.10	1.25±0.10

X5R Dielectric

Size (EIA Code)	CM02 (01005)			CM03 (0201)				CM05 (0402)					CM105 (0603)					CM21 (0805)									
	6.3	10	16	6.3	10	16	25	4	6.3	10	16	25	35	4	6.3	10	16	25	50	4	6.3	10	16	25	50		
Rated Voltage (VDC)																											
Capacitance (pF)																											
101 100																											
151 150																											
220																											
330																											
470																											
680																											
102 1000																											
152 1500																											
2200																											
3300																											
4700																											
6800																											
103 10000																											
153 15000																											
22000																											
33000																											
47000																											
68000																											
104 100000																											
220000																											
470000																											
105 1000000																											
2200000																											
4700000																											
106 10000000																											
22000000																											
47000000																											
107 100000000																											

Size (EIA Code)	CM316 (1206)					CM32 (1210)					CM43 (1812)				
	6.3	10	16	25	50	100	4	6.3	10	16	25	50	6.3	50	
Rated Voltage (VDC)															
Capacitance (pF)															
105 220000															
470000															
1000000															
2200000															
4700000															
106 10000000															
22000000															
47000000															
107 100000000															

<Standard Capacitance Value>
 CM21 size and smaller : E6 Series
 CM316 size and larger / capacitance value of 0.1μF and larger : E3 Series
 Please contact for capacitance value other than standard.
 Optional Spec.

Two digits alphanumeric in capacitance chart denote dimensions and tan δ.
 Please refer to the below table for detail.

(Example)
 In case of "B3" for CM03;
 L : 0.6±0.03mm
 W : 0.3±0.03mm
 T : 0.3±0.03mm
 Tan δ : 5.0% max.

Size	Size Code	Dimension (mm)		
		L	W	T
02	A	0.4±0.02	0.2±0.02	0.2±0.02
	B	0.6±0.03	0.3±0.03	0.3±0.03
03	C	0.6±0.05	0.3±0.05	0.3±0.05
	D	0.6±0.09	0.3±0.09	0.3±0.09
05	E	1.0±0.05	0.5±0.05	0.5±0.05
	H	1.0±0.10	0.5±0.10	0.5±0.10
	J	1.0±0.15	0.5±0.15	0.5±0.15
	L	1.0±0.20	0.5±0.20	0.5±0.20
105	B	1.6±0.10	0.8±0.10	0.8±0.10
	D	1.6±0.15	0.8±0.15	0.8±0.15
21	G	2.0±0.10	1.25±0.10	1.25±0.10
	K	2.0±0.15	1.25±0.15	1.25±0.15
	M	2.0±0.20	1.25±0.20	1.25±0.20

Size	Size Code	Dimension (mm)		
		L	W	T
316	E	3.2±0.20	1.6±0.15	1.6±0.15
	H	3.2±0.20	1.6±0.20	1.6±0.20
	B	3.2±0.30	2.5±0.20	1.40 max.
32	C	3.2±0.30	2.5±0.20	1.60 max.
	F	3.2±0.30	2.5±0.20	2.0±0.2
	G	3.2±0.30	2.5±0.20	2.5±0.2
43	D	4.5±0.30	3.2±0.20	2.5±0.2
	E	4.5±0.30	3.2±0.20	2.8±0.2

Tan δ Code	Tan δ
3	5.0% max.
4	7.0% max.
5	7.5% max.
7	10.0% max.
8	12.5% max.
9	15.0% max.
10	20.0% max.



**Test Conditions and Specifications for Temperature Compensation Type (CΔ Characteristics)
CM/ CU/ CF Series**

Test Items		Test Conditions			Specifications												
Capacitance Value (C)		<table border="1"> <thead> <tr> <th>Capacitance</th> <th>Frequency</th> <th colspan="2">Volt</th> </tr> </thead> <tbody> <tr> <td>C≤1000pF</td> <td>1MHz±10%</td> <td colspan="2">0.5 to 5Vrms</td> </tr> <tr> <td>C>1000pF</td> <td>1kHz±10%</td> <td colspan="2"></td> </tr> </tbody> </table>			Capacitance	Frequency	Volt		C≤1000pF	1MHz±10%	0.5 to 5Vrms		C>1000pF	1kHz±10%			Within tolerance
Capacitance	Frequency	Volt															
C≤1000pF	1MHz±10%	0.5 to 5Vrms															
C>1000pF	1kHz±10%																
Q					C≥30pF : Q≥1000 C<30pF : Q≥400+20C												
Insulation Resistance (IR)		<p>Measured after the rated voltage is applied for 1 minute at room ambient. For the rated voltage of over 630V, apply 500V for 1 minute at room ambient. The charge and discharge current of the capacitor must not exceed 50mA.</p>			Over 10000MΩ or 500MΩ • μF, whichever is less												
Dielectric Resistance		<p>Apply 3 times of the rated voltage for 1 to 5 seconds. Apply 1.5 times when the rated voltage is 250V or over. Apply 1.2 times when the rated voltage is 630V or over. The charge and discharge current of the capacitor must not exceed 50mA.</p>			No problem observed												
Appearance		Microscope			No problem observed												
Termination Strength		<p>Apply a sideward force of 500g (5N) to a PCB-mounted sample. Apply 2N for 0201, and 1N for 01005 size.</p>			No problem observed												
Bending Strength		Glass epoxy PCB: Fulcrum spacing: 90mm, duration time 10 seconds.			No significant damage at 1mm bent												
Vibration Test	Appearance	<p>Vibration frequency: 10 to 55 (Hz) Amplitude: 1.5mm Sweeping condition: 10→55→10Hz/ 1 minute in X, Y and Z Directions: 2 hours each, 6 hours total.</p>			No problem observed												
	ΔC				Within Tolerance												
	Q				C≥30pF : Q≥1000 C<30pF : Q≥400+20C												
Soldering Heat Resistance	Appearance	<p>Soak the sample in 260°C±5°C solder for 10±0.5 seconds and place in room ambient, and measure after 24±2 hours. (Pre-heating conditions)</p>			No problem observed												
	ΔC				Within ±2.5% or ±0.25pF, whichever is larger												
	Q				C≥30pF : Q≥1000 C<30pF : Q≥400+20C												
	IR	<table border="1"> <thead> <tr> <th>Order</th> <th>Temperature</th> <th colspan="2">Time</th> </tr> </thead> <tbody> <tr> <td>1</td> <td>80 to 100°C</td> <td colspan="2">2 minutes</td> </tr> <tr> <td>2</td> <td>150 to 200°C</td> <td colspan="2">2 minutes</td> </tr> </tbody> </table>			Order	Temperature	Time		1	80 to 100°C	2 minutes		2	150 to 200°C	2 minutes		Over 10000MΩ or 500MΩ • μF whichever is less
	Order	Temperature	Time														
1	80 to 100°C	2 minutes															
2	150 to 200°C	2 minutes															
Withstanding Voltage	<p>The charge and discharge current of the capacitor must not exceed 50mA for IR and withstanding voltage measurement.</p>			Resist without problem													
Solderability		<p>Soaking condition</p> <table border="1"> <tbody> <tr> <td>Sn-3Ag-0.5Cu</td> <td>245±5°C</td> <td colspan="2">3±0.5 sec.</td> </tr> <tr> <td>Sn63 Solder</td> <td>235±5°C</td> <td colspan="2">2±0.5 sec.</td> </tr> </tbody> </table>			Sn-3Ag-0.5Cu	245±5°C	3±0.5 sec.		Sn63 Solder	235±5°C	2±0.5 sec.		Solder coverage : 90% min.				
Sn-3Ag-0.5Cu	245±5°C	3±0.5 sec.															
Sn63 Solder	235±5°C	2±0.5 sec.															
Temperature Cycle	Appearance	(Cycle)			No problem observed												
	ΔC	Room temperature (3min.)→			Within ±2.5% or ±0.25pF, whichever is larger												
	Q	Lowest operation temperature (30min.)→ Room temperature (3min.)→			C≥30pF : Q≥1000 C<30pF : Q≥400+20C												
	IR	Highest operation temperature(30min.)			Over 10000MΩ or 500MΩ • μF, whichever is less												
	Withstanding Voltage	<p>After 5 cycles, measure after 24±2 hours. The charge and discharge current of the capacitor must not exceed 50mA for IR and withstanding voltage measurement.</p>			Resist without problem												
Load Humidity Test (Except CF Series)	Appearance	<p>After applying rated voltage for 500+12/ -0 hours in pre-condition at 40°C±2°C, humidity 90 to 95%RH, allow parts to stabilize for 24±2 hours, at room temperature before measurement. The charge and discharge current of the capacitor must not exceed 50mA for IR measurement.</p>			No problem observed												
	ΔC				Within ±7.5% or ±0.75pF, whichever is larger												
	Q				C≥30pF : Q≥200 C<30pF : Q≥100+10C/ 3												
	IR				Over 500MΩ or 25MΩ • μF, whichever is less												
High-Temperature with Loading	Appearance	<p>After applying twice the rated voltage at the temperature of 125±3°C for 1000+12/ -0 hours, measure the sample after 24±2 hours.</p>			No problem observed.												
	ΔC	<p>Apply 1.5 times when the rated voltage is 250V or over. Apply 1.2 times when the rated voltage is 630V or over. The charge and discharge current of the capacitor must not exceed 50mA for IR measurement.</p>			Within ±3% or ±0.3pF, whichever is larger												
	Q				C≥30pF : Q≥350 10pF<C<30pF : Q≥275+5C/ 2 C<10pF : Q≥200+10C												
	IR				Over 1000MΩ or 50MΩ • μF, whichever is less												

Please ask for individual specification for the hatched range in previous chart.



**Test Conditions and Specifications for High Dielectric Type (X5R, X7R)
CM/ CT Series**

Test Items		Test Conditions	Specifications									
Capacitance Value (C)		Measure after heat treatment	Within tolerance									
Tanδ (%)		<table border="1"> <thead> <tr> <th>Capacitance</th> <th>Frequency</th> <th>Volt</th> </tr> </thead> <tbody> <tr> <td>C≤10μF</td> <td>1kHz±10%</td> <td>1.0±0.2Vrms</td> </tr> <tr> <td>C>10μF</td> <td>120Hz±10%</td> <td>0.5±0.2Vrms</td> </tr> </tbody> </table>	Capacitance	Frequency	Volt	C≤10μF	1kHz±10%	1.0±0.2Vrms	C>10μF	120Hz±10%	0.5±0.2Vrms	Refer to capacitance chart
Capacitance	Frequency	Volt										
C≤10μF	1kHz±10%	1.0±0.2Vrms										
C>10μF	120Hz±10%	0.5±0.2Vrms										
Insulation Resistance (IR)		Measured after the rated voltage is applied for 1 minute at room ambient. The charge and discharge current of the capacitor must not exceed 50mA.	Over 10000MΩ or 500MΩ • μF, whichever is less									
Dielectric Resistance		Apply 2.5 times of the rated voltage for 1 to 5 seconds. The charge and discharge current of the capacitor must not exceed 50mA.	No problem observed									
Appearance		Microscope	No problem observed									
Termination Strength		Apply a sideward force of 500g (5N) to a PCB-mounted sample. note : 2N for 0201 size in for 01005 size. Exclude CT series with thickness of less than 0.66mm.	No problem observed									
Bending Strength		Glass epoxy PCB: Fulcrum spacing: 90mm, duration time 10 seconds. Exclude CT series with thickness of less than 0.66mm.	No significant damage at 1mm bent									
Vibration Test	Appearance	Take the initial value after heat treatment. Vibration frequency: 10 to 55 (Hz) Amplitude: 1.5mm Sweeping condition: 10→55→10Hz/ 1 minute in X, Y and Z Directions: 2 hours each, 6 hours total.	No problem observed									
	ΔC		Within tolerance									
	Tanδ (%)		Within tolerance									
Soldering Heat Resistance	Appearance	Take the initial value after heat treatment. Soak the sample in 260°C±5°C solder for 10±0.5 seconds and place in room ambient, and measure after 24±2 hours. (Pre-heating conditions)	No problem observed									
	ΔC		Within ±7.5%									
	Tanδ (%)		Within tolerance									
	IR		Over 10000MΩ or 500MΩ • μF, whichever is less									
	Withstanding Voltage		<table border="1"> <thead> <tr> <th>Order</th> <th>Temperature</th> <th>Time</th> </tr> </thead> <tbody> <tr> <td>1</td> <td>80 to 100°C</td> <td>2 minutes</td> </tr> <tr> <td>2</td> <td>150 to 200°C</td> <td>2 minutes</td> </tr> </tbody> </table>	Order	Temperature	Time	1	80 to 100°C	2 minutes	2	150 to 200°C	2 minutes
Order	Temperature	Time										
1	80 to 100°C	2 minutes										
2	150 to 200°C	2 minutes										
Solderability		Soaking condition	Solder coverage : 90% min.									
		<table border="1"> <thead> <tr> <th>Sn-3Ag-0.5Cu</th> <th>Temperature</th> <th>Time</th> </tr> </thead> <tbody> <tr> <td>Sn63 Solder</td> <td>245±5°C</td> <td>3±0.5 sec.</td> </tr> <tr> <td></td> <td>235±5°C</td> <td>2±0.5 sec.</td> </tr> </tbody> </table>	Sn-3Ag-0.5Cu	Temperature	Time	Sn63 Solder	245±5°C	3±0.5 sec.		235±5°C	2±0.5 sec.	
Sn-3Ag-0.5Cu	Temperature	Time										
Sn63 Solder	245±5°C	3±0.5 sec.										
	235±5°C	2±0.5 sec.										
Temperature Cycle	Appearance	Take the initial value after heat treatment. (Cycle) Room temperature (3min.)→ Lowest operation temperature (30min.)→ Room temperature (3min.)→ Highest operation temperature(30min.) After 5 cycles, measure after 24±2 hours. The charge and discharge current of the capacitor must not exceed 50mA for IR and withstanding voltage measurement.	No problem observed									
	ΔC		Within ±7.5%									
	Tanδ (%)		Within tolerance									
	IR		Over 10000MΩ or 500MΩ • μF, whichever is less									
	Withstanding Voltage		Resist without problem									
Load Humidity Test	Appearance	Take the initial value after voltage treatment. After applying rated voltage for 500+12/-0 hours in pre-condition at 40°C±2°C, humidity 90 to 95%RH, allow parts to stabilize for 24±2 hours, at room temperature before measurement. The charge and discharge current of the capacitor must not exceed 50mA for IR measurement.	No problem observed									
	ΔC		Within ±12.5%									
	Tanδ (%)		200% max. of initial value									
	IR		Over 500MΩ or 25MΩ • μF, whichever is less									
High-Temperature with Loading	Appearance	Take the initial value after voltage treatment. After applying twice the rated voltage at the highest operation temperature for 1000+12/-0 hours, measure the sample after 24±2 hours. The charge and discharge current of the capacitor must not exceed 50mA for IR measurement. Apply 1.5 times when the rated voltage is 10V or less. Applied voltages for respective products are indicated in the below chart.	No problem observed									
	ΔC		Within ±12.5%									
	Tanδ (%)		200% max. of initial value									
	IR		Over 1000MΩ or 50MΩ • μF, whichever is less									

Pre-treatment	Heat	Keep specimen at 150+0/-10°C for 1 hour, leave specimen at room ambient for 24±2 hours.
	Voltage	Apply the same test condition for 1 hour, then leave the specimen at room ambient for 24±2 hours.

High-temperature with Loading Applied Voltage (Rated Voltage × □)

Applied Voltage	Rated Voltage	Products
×1.3	4V	CT03X5R104
	6.3V	CM105X5R475, CM316X5R476, CM02X5R153-104 CT05X5R104, CT21X5R106, CT03X5R104
×1.5	16V	CM02X7R101-222, CM05X7R333-104, CM105X7R474-105, CM21X7R105-475, CM316X7R475-106, CM32X7R106-226, CM05X5R224, CM105X5R225, CM21X5R475-106, CM316X5R226 CT105X5R105, CT21X5R225-475, CT316X5R106, CM03X5R332-103, CM02X5R101-103
	25V	CM105X7R474, CM21X7R105-225, CM316X7R475, CM32X7R106, CM105X5R474-105, CM21X5R225-106, CM316X5R106, CM32X5R106-226 CT316X5R225-106, CM03X5R152-103, CM05X7R103-104
	50V	CM21X5R105, CM32X5R106, CM32X7R106 CT21X5R225, CT316X5R105-475
	100V	CM32X7RK74, CM43X7R105

Please ask for individual specification for the hatched range in previous chart.



Substrate for Electrical Tests

(Unit: mm)

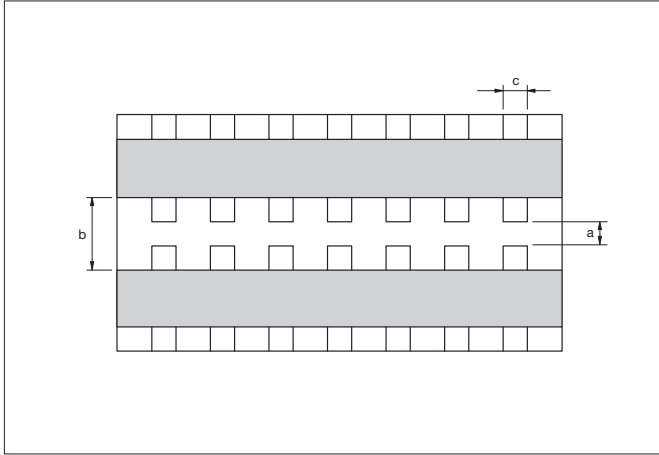

Size (EIA Code)	a	b	c
02 (01005)	0.15	0.50	0.20
03 (0201)	0.26	0.92	0.32
05 (0402)	0.4	1.4	0.5
105 (0603)	1.0	3.0	1.2
21 (0805)	1.2	4.0	1.65
316 (1206)	2.2	5.0	2.0
32 (1210)	2.2	5.0	2.9
42 (1808)	3.5	7.0	3.7
43 (1812)	3.5	7.0	3.7
52 (2208)	4.5	8.0	5.6
55 (2220)	4.5	8.0	5.6

Substrate for Bending Test

(Unit: mm)

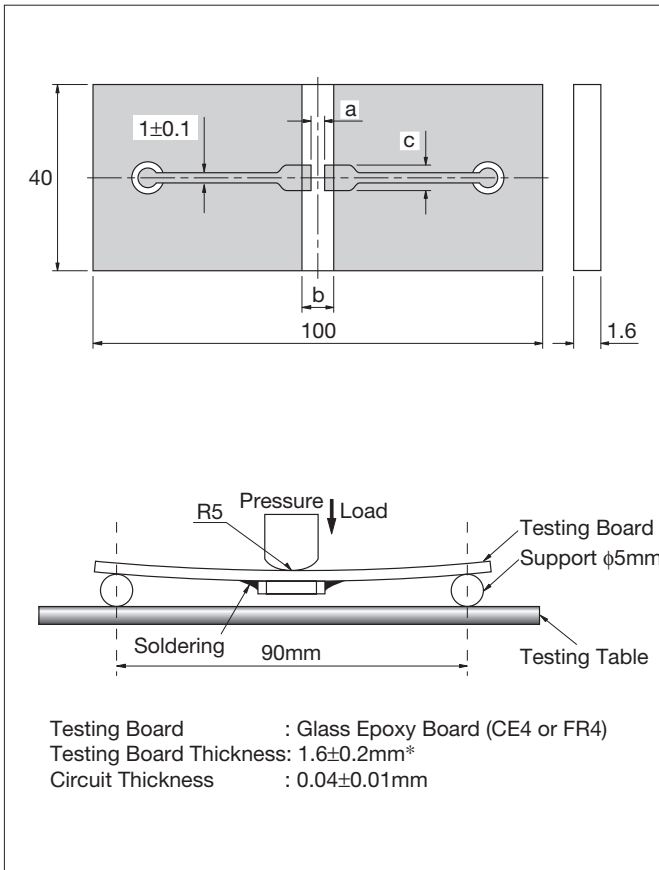

* 02, 03, 05 size 0.8 ± 0.1 mm

Substrate for Adhesion Strength Test

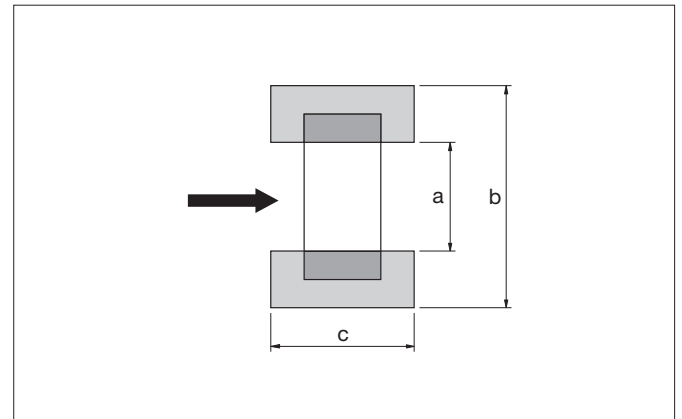



Tape and Reel

- Reel

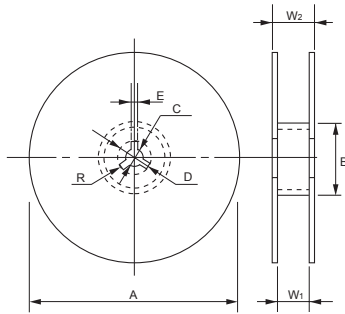

F=1mm (02 Type)

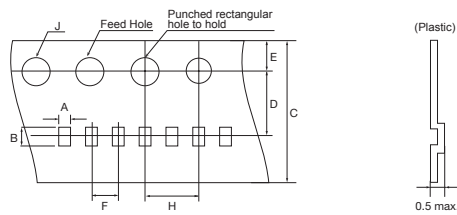

F=1mm (02, 03, 05 Type)

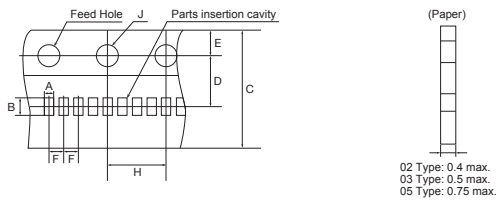

F=2mm (02, 03, 05, 105 Type)

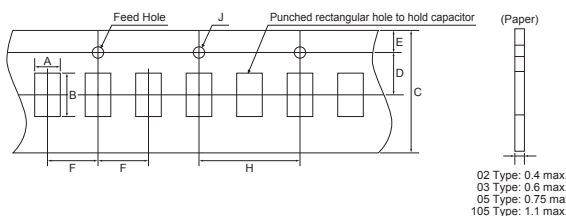

F=4mm (105, 21, 316, 32, 42, 52 Type)

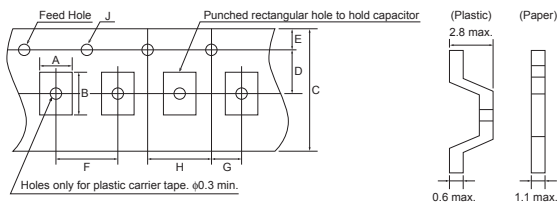

F=8mm (43, 55 Type)

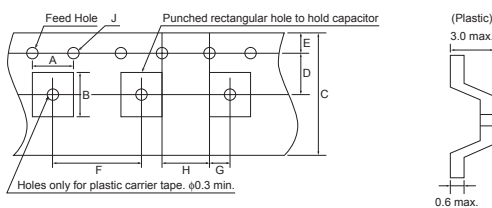

Reel

(Unit: mm)

Code Reel	A	B	C	D
7-inch Reel (CODE: T, H, Q)	180 ⁺⁰ _{-2.0}	$\phi 60$ min.	13 ± 0.5	21 ± 0.8
7-inch Reel (CODE: P)	178 ± 2.0			
13-inch Reel (CODE: L, N, W)	330 ± 2.0			
Code Reel	E	W ₁	W ₂	R
7-inch Reel (CODE: T, H, Q)	2.0 ± 0.5	10.5 ± 1.5	16.5 max.	1.0
7-inch Reel (CODE: P)		4.35 ± 0.3	6.95 ± 1.0	
13-inch Reel (CODE: L, N, W)		9.5 ± 1.0	16.5 max.	

* Carrier tape width 8mm.

For size 42 (1808) or over, Tape width 12mm and W₁: 14 ± 1.5 , W₂: 18.4mm max.

Carrier Tape

(Unit: mm)

Size (EIA Code)	A	B	F
02 (01005)*	0.23 ± 0.02	0.43 ± 0.02	1.0 ± 0.02
	0.25 ± 0.03	0.45 ± 0.03	2.0 ± 0.05
03 (0201)*	0.37 ± 0.03	0.67 ± 0.03	1.0 ± 0.05
			2.0 ± 0.05
05 (0402)*	0.65 ± 0.1	1.15 ± 0.1	1.0 ± 0.05
			2.0 ± 0.05
105 (0603)	1.0 ± 0.2	1.8 ± 0.2	4.0 ± 0.1
21 (0805)	1.5 ± 0.2	2.3 ± 0.2	4.0 ± 0.1
316 (1206)	2.0 ± 0.2	3.6 ± 0.2	4.0 ± 0.1
32 (1210)	2.9 ± 0.2	3.6 ± 0.2	4.0 ± 0.1
42 (1808)	2.4 ± 0.2	4.9 ± 0.2	4.0 ± 0.1
43 (1812)	3.6 ± 0.2	4.9 ± 0.2	8.0 ± 0.1
52 (2208)	2.4 ± 0.2	6.0 ± 0.2	4.0 ± 0.1
55 (2220)	5.3 ± 0.2	6.0 ± 0.2	8.0 ± 0.1

* Option

(Unit: mm)

F	Carrier Tape	C	D	E	G	H	J
1.0 ± 0.02	4mm Plastic	4.0 ± 0.08	1.8 ± 0.02	0.9 ± 0.05	-	2.0 ± 0.04	0.8 ± 0.04
1.0 ± 0.05	8mm Paper	8.0 ± 0.3	3.5 ± 0.05	1.75 ± 0.1	2.0 ± 0.05	4.0 ± 0.1	1.5 ± 0.1
2.0 ± 0.05		8.0 ± 0.3					
4.0 ± 0.1	8mm Plastic	12.0 ± 0.3	5.5 ± 0.05	1.75 ± 0.1	2.0 ± 0.05	4.0 ± 0.1	1.5 ± 0.1
8.0 ± 0.1	12mm Plastic						



Detail of leader and trailer

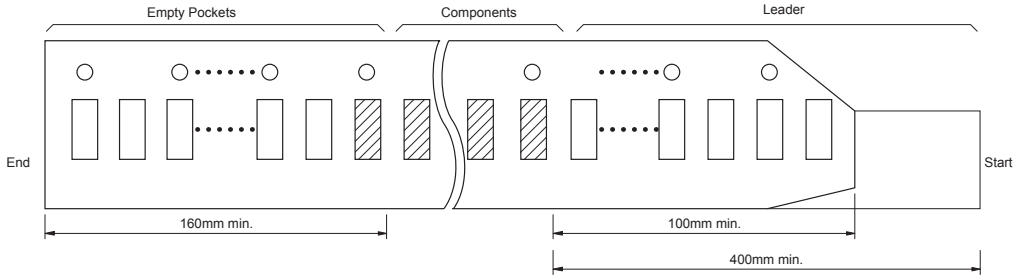

Adhesive tape

- 1) The exfoliative strength when peeling off the top tape from the carrier tape by the method of the following figure shall be ≈ 0.1 to $0.7N$. *02 Size: 0.1 to 0.5N
- 2) When the top tape is peeled off, the adhesive stays on the top tape.
- 3) Chip capacitors will be in a state free without being stuck on the thermal adhesive tape.

Exfoliating angle: 165 to 180 degrees to the carrier tape.
Exfoliating speed: 300 mm/min.

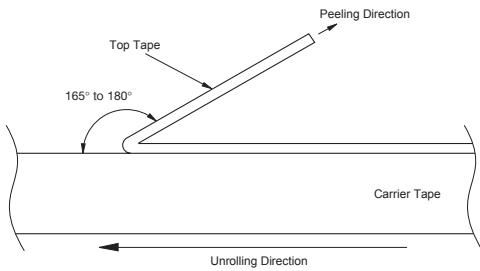

Bulk Case

(Unit: mm)

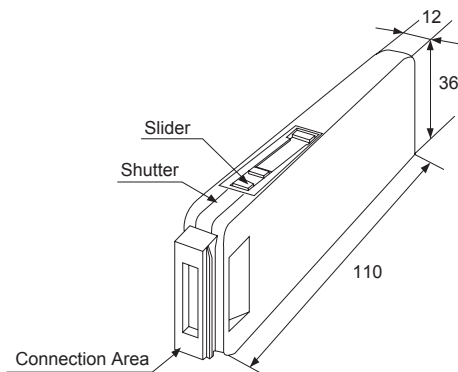

• Please contact Kyocera for details.



Dimensions for recommended typical land

Since the amount of solder (size of fillet) to be used has direct influence on the capacitor after mounting, the sufficient consideration is necessary.

When the amounts of solder is too much, the stress that a capacitor receives becomes larger. It may become the cause of a crack in the capacitor. When the land design of printed wiring board is considered, it is necessary to set up the form and size of land pattern so that the amount of solder is suitable.

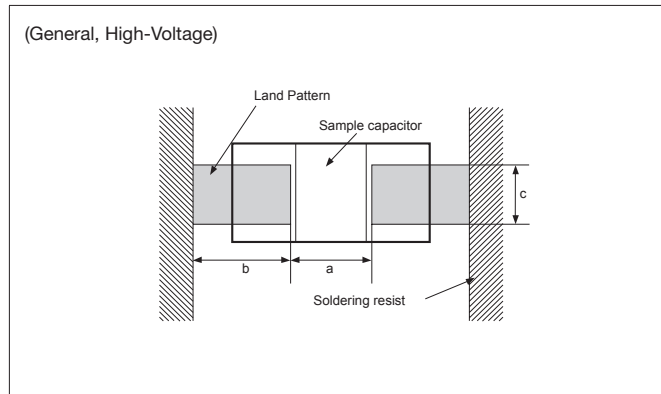

General, High-Voltage

(Unit: mm)

Size (EIA Code)	L×W	a	b	c
02 (01005)	0.4×0.2	0.13 to 0.20	0.12 to 0.18	0.20 to 0.23
03 (0201)	0.6×0.3	0.20 to 0.30	0.25 to 0.35	0.30 to 0.40
05 (0402)	1.0×0.5	0.30 to 0.50	0.35 to 0.45	0.40 to 0.60
105 (0603)	1.6×0.8	0.70 to 1.00	0.80 to 1.00	0.60 to 0.80
21 (0805)	2.0×1.25	1.00 to 1.30	1.00 to 1.20	0.80 to 1.10
316 (1206)	3.2×1.6	2.10 to 2.50	1.10 to 1.30	1.00 to 1.30
32 (1210)	3.2×2.5	2.10 to 2.50	1.10 to 1.30	1.90 to 2.30
42 (1808)	4.5×2.0	2.50 to 3.20*1	1.80 to 2.30	1.50 to 1.80
43 (1812)	4.5×3.2	2.50 to 3.20*1	1.80 to 2.30	2.60 to 3.00
52 (2208)	5.7×2.0	4.20 to 4.70	2.00 to 2.50	1.50 to 1.80
55 (2220)	5.7×5.0	4.20 to 4.70	2.00 to 2.50	4.20 to 4.70

*1 Dimension of 3.0 to 3.5mm is recommended for "a", in the case of High-Voltage products.

Design of printed circuit and Soldering

The recommended fillet height shall be 1/2 of the thickness of capacitors or 0.5mm. When mounting two or more capacitors in the common land, it is necessary to separate the land with the solder resist strike so that it may become the exclusive land of each capacitor.

Ideal Solder Height

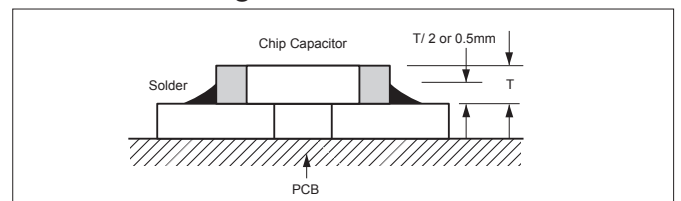

Item	Not recommended example	Recommended example/ Separated by solder
Multiple parts mount		
Mount with leaded parts		
Wire soldering after mounting		
Overview		



Mounting Design

The chip could crack if the PCB warps during processing after the chip has been soldered.

Recommended chip position on PCB to minimize stress from PCB warpage



Actual Mounting

- 1) If the position of the vacuum nozzle is too low, a large force may be applied to the chip capacitor during mounting, resulting in cracking.
- 2) During mounting, set the nozzle pressure to a static load of 1 to 3 N.
- 3) To minimize the shock of the vacuum nozzle, provide a support pin on the back of the PCB to minimize PCB flexure.

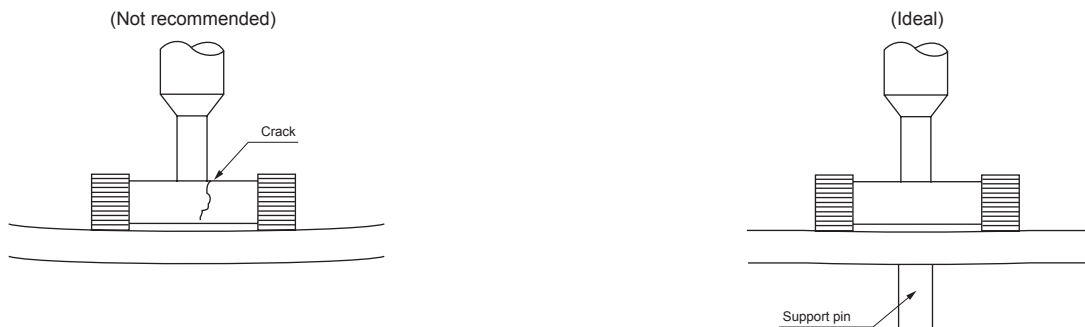

- 4) Bottom position of pick up nozzle should be adjusted to the top surface of a substrate which camber is corrected.
- 5) To reduce the possibility of chipping and cracks, minimize vibration to chips stored in a bulk case.
- 6) The discharge pressure must be adjusted to the part size. Verify the pressure during setup to avoid fracturing or cracking the chips capacitors.

Resin Mold

- 1) If a large amount of resin is used for molding the chip, cracks may occur due to contraction stress during curing. To avoid such cracks, use a low shrinkage resin.
- 2) The insulation resistance of the chip will degrade due to moisture absorption. Use a low moisture absorption resin.
- 3) Check carefully that the resin does not generate a decomposition gas or reaction gas during the curing process or during normal storage. Such gases may crack the chip capacitor or damage the device itself.



Soldering Method

- 1) Ceramic is easily damaged by rapid heating or cooling. If some heat shock is unavoidable, preheat enough to limit the temperature difference (Delta T) to within 150 degree Celsius.
- 2) The product size 1.6×0.8mm to 3.2×1.6mm can be used in reflow and wave soldering, and the product size of bigger than 3.2×1.6mm, or smaller than 1.6×0.8mm can be used in reflow.
Circuit shortage and smoking can be created by using capacitors which are used neglecting the above caution.
- 3) Please see our recommended soldering conditions.
- 4) In case of using Sn-Zn Solder, please contact us in advance.
- 5) The following condition is recommended for spot heater application.

• Recommended spot heater condition

Item	Condition
Distance	5mm min.
Angle	45°
Projection Temp.	400°C max.
Flow rate	Set at the minimum
Nozzle diameter	2φ to 4φ (Single hole type)
Application time	10 sec. max. (1206 and smaller) 30 sec. max. (1210 and larger)

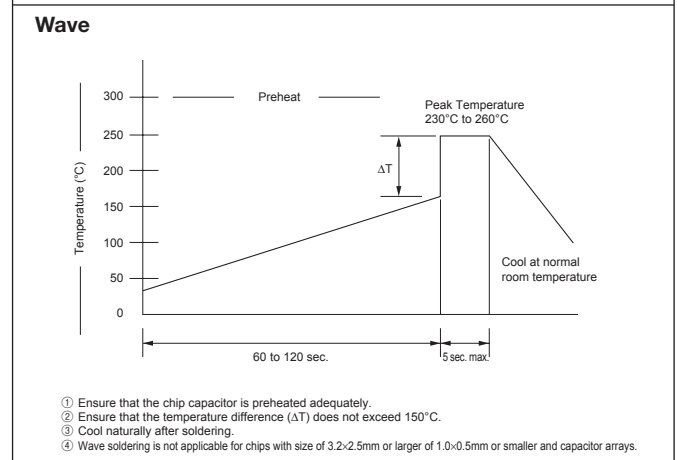
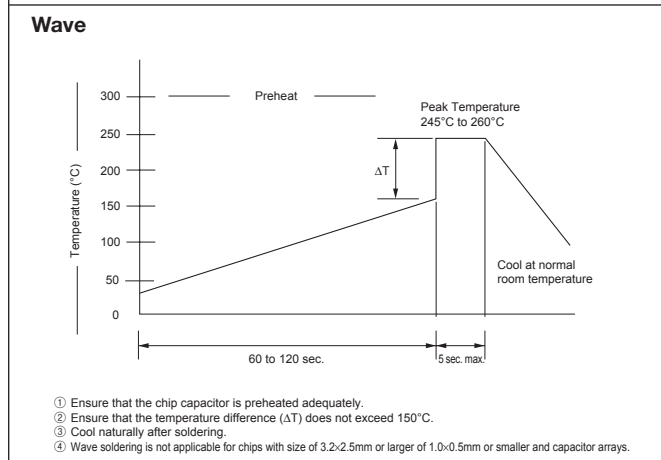
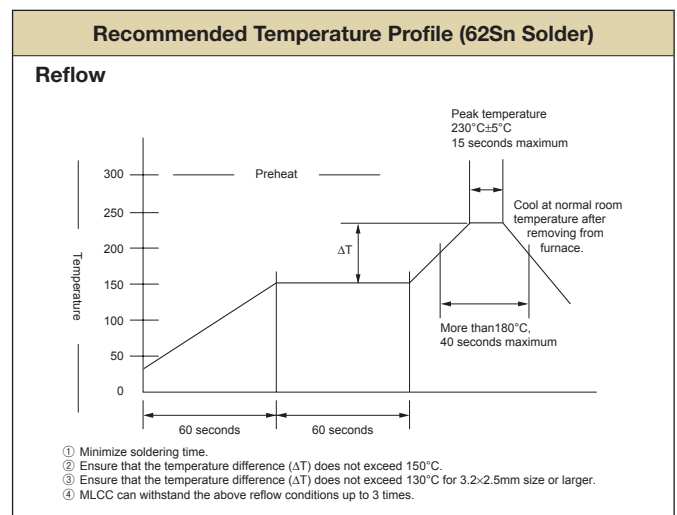
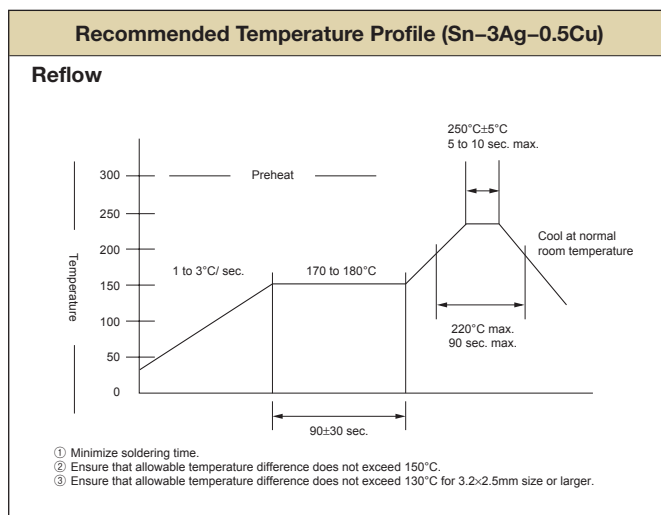
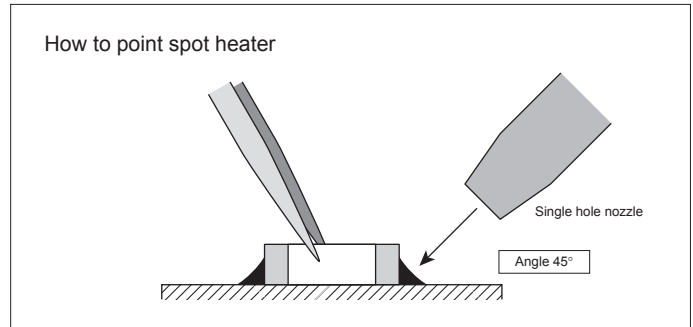

Soldering iron

- | | | |
|--------------------------------|---|--|
| 1) Temperature of iron chip | 1206 and smaller 350°C max.
1210 and larger 280°C max. | 5) Cautions |
| 2) Wattage | 80W max. | a) Pre-heating is necessary rapid heating must be avoided.
Delta T≤150°C (product size of bigger than 3.2×1.6mm. Delta T≤130°C) |
| 3) Tip shape of soldering iron | φ3.0mm max. | b) Avoid direct touching to capacitors. |
| 4) Soldering Time | 3 sec. max. | c) Avoid rapid cooling after soldering. Natural cooling is recommended. |
- *Consult as if it is difficult to keep the temperature 280°C max. for 1210 and larger MLCC'S.



Circuit Design

1. Once application and assembly environments have been checked, the capacitor may be used in conformance with the rating and performance which are provided in both the catalog and the specifications. Use exceeding that which is specified may result in inferior performance or cause a short, open, smoking, or flaming to occur, etc.
2. Please consult the manufacturer in advance when the capacitor is used in devices such as: devices which deal with human life, i.e. medical devices; devices which are highly public orientated; and devices which demand a high standard of liability.
Accident or malfunction of devices such as medical devices, space equipment and devices having to do with atomic power could generate grave consequence with respect to human lives or, possibly, a portion of the public. Capacitors used in these devices may require high reliability design different from that of general purpose capacitors.
3. Please use the capacitors in conformance with the operating temperature provided in both the catalog and the specifications.
Be especially cautious not to exceed the maximum temperature. In the situation the maximum temperature set forth in both the catalog and specifications is exceeded, the capacitor's insulation resistance may deteriorate, power may suddenly surge and short-circuit may occur. The capacitor has a loss, and may self-heat due to equivalent series resistance when alternating electric current is passed therethrough. As this effect becomes especially pronounced in high frequency circuits, please exercise caution.
When using the capacitor in a (self-heating) circuit, please make sure the surface of the capacitor remains under the maximum temperature for usage. Also, please make certain temperature rises remain below 20°C.
4. Please keep voltage under the rated voltage which is applied to the capacitor. Also, please make certain the peak voltage remains below the rated voltage when AC voltage is super-imposed to the DC voltage.
In the situation where AC or pulse voltage is employed, ensure average peak voltage does not exceed the rated voltage.
Exceeding the rated voltage provided in both catalog and specifications may lead to defective withstanding voltage or, in worst case situations, may cause the capacitor to smoke or flame.
5. When the capacitor is to be employed in a circuit in which there is continuous application of a high frequency voltage or a steep pulse voltage, even though it is within the rated voltage, please inquire to the manufacturer.
In the situation the capacitor is to be employed using a high frequency AC voltage or a extremely fast rising pulse voltage, even though it is within the rated voltage, it is possible capacitor reliability will deteriorate.
6. It is a common phenomenon of high-dielectric products to have a deteriorated amount of static electricity due to the application of DC voltage.
Due caution is necessary as the degree of deterioration varies depending on the quality of capacitor materials, capacity, as well as the load voltage at the time of operation.
7. Do not use the capacitor in an environment where it might easily exceed the respective provisions concerning shock and vibration specified in the catalog and specifications.
In addition, it is a common piezo phenomenon of high dielectric products to have some voltage due to vibration or to have noise due to voltage change. Please contact sales in such case.
8. If the electrostatic capacity value of the delivered capacitor is within the specified tolerance, please consider this when designing the respective product in order that the assembled product function appropriately.
9. Please contact us upon using conductive adhesives.

Storage

1. If the component is stored in minimal packaging (a heat-sealed or zippered plastic bag), the bag should be kept closed. Once the bag has been opened, reseal it or store it in a desiccator.
2. Keep storage place temperature +5 to +40 degree C, humidity 20 to 70% RH. See JIS C 60721-3-1, class 1K2 for other climatic conditions.
3. The storage atmosphere must be free of corrosive gas such as sulfur dioxide and chlorine. Also, avoid exposing the product to saline moisture. If the product is exposed to such atmospheres, the terminals will oxidize and solderability will be effected.
4. Precautions 1) to 3) apply to chip capacitors packaged in carrier tapes and bulk cases.
5. The solderability is assured for 6 months from our shipping date if the above storage precautions are followed.
6. Chip capacitors may crack if exposed to hydrogen (H₂) gas while sealed or if coated with silicon, which generates hydrogen gas.

Safety application guideline and detailed information of electrical properties are also provided in Kyocera home page;

URL: <http://www.kyocera.co.jp/electronic/>