

| | |
|---|---------------|
| For board-to-FPC | <h1>A35S</h1> |
| Narrow pitch connectors (0.35mm pitch) | |

Contributes to device miniaturization and advanced functionality with 2.5 mm width, 0.35 mm pitch and 0.8 mm mated height!

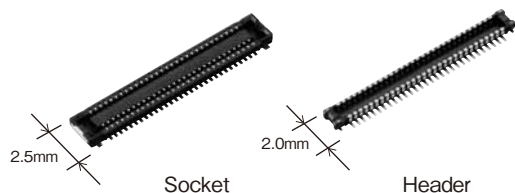

FEATURES

- 0.35 mm terminal pitch, 2.5 mm width and 0.8 mm mated height
- Low profile type with up to 100 pins.
- “TOUGH CONTACT” construction provides high resistance to various environmental.
- Simple lock structure provides tactile feedback to ensure excellent mating/unmating operation feel.
- Connectors for inspection available

APPLICATIONS

Smartphones, tablet PC and other mobile devices

DETAILED FEATURES

0.35 mm terminal pitch, 2.5 mm width and 0.8 mm mated height

When mated, the footprint is reduced by approx. 10% from A4S (60 pins), contributing to the functionality enhancement and size reduction of end equipment.

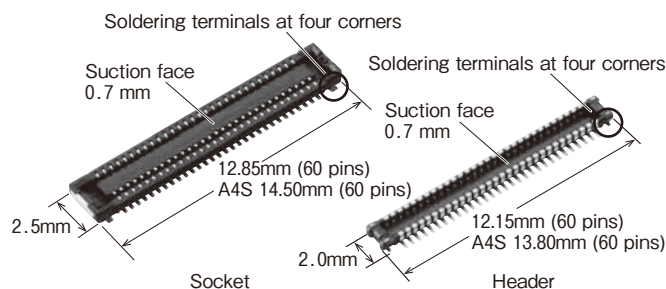

High resistance to various environments!
“TOUGH CONTACT” construction provides high contact reliability

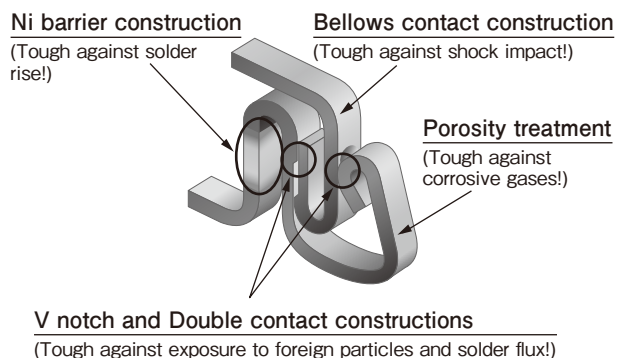

ORDERING INFORMATION

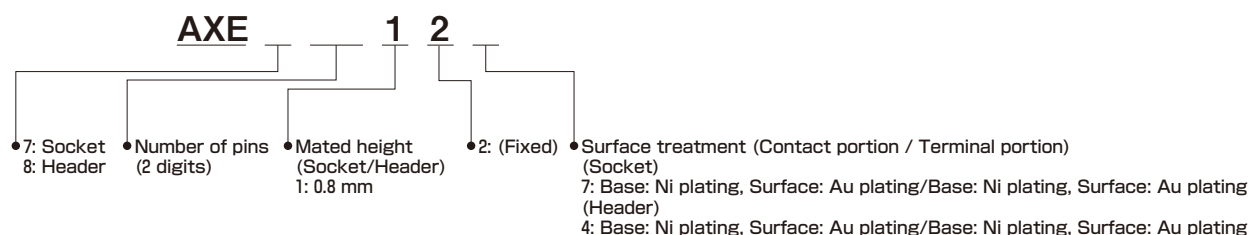

PRODUCT TYPES

| Mated height | Number of pins | Part number | | Packing | |
|--------------|----------------|-------------|-----------|-----------------------|---------------|
| | | Socket | Header | Inner carton (1-reel) | Outer carton |
| 0.8mm | 10 | AXE710127 | AXE810124 | 5,000 pieces | 10,000 pieces |
| | 12 | AXE712127 | AXE812124 | | |
| | 16 | AXE716127 | AXE816124 | | |
| | 20 | AXE720127 | AXE820124 | | |
| | 24 | AXE724127 | AXE824124 | | |
| | 30 | AXE730127 | AXE830124 | | |
| | 34 | AXE734127 | AXE834124 | | |
| | 40 | AXE740127 | AXE840124 | | |
| | 44 | AXE744127 | AXE844124 | | |
| | 50 | AXE750127 | AXE850124 | | |
| | 54 | AXE754127 | AXE854124 | | |
| | 60 | AXE760127 | AXE860124 | | |
| | 64 | AXE764127 | AXE864124 | | |
| | 70 | AXE770127 | AXE870124 | | |
| | 80 | AXE780127 | AXE880124 | | |
| 100 | AXE700127 | AXE800124 | | | |

Notes: 1. Order unit: For volume production: 1-inner carton (1-reel) units. For samples, please contact our sales office.
2. Please contact our sales office for connectors having a number of pins other than those listed above.

SPECIFICATIONS**1. Characteristics**

| | Item | Specifications | Conditions | | |
|---|---|--|--|-------------------|----------------|
| Electrical characteristics | Rated current | 0.25A/pin contact (Max. 4 A at total pin contacts) | | | |
| | Rated voltage | 60V AC/DC | | | |
| | Dielectric strength | 150V AC for 1 min. | No short-circuiting or damage at a detection current of 1 mA when the specified voltage is applied for one minute. | | |
| | Insulation resistance | Min. 1.000M Ω (initial) | Using 250V DC megger (applied for 1 min.) | | |
| | Contact resistance | Max. 100m Ω | Based on the contact resistance measurement method specified by JIS C 5402. | | |
| Mechanical characteristics | Composite insertion force | Max. 0.981N/pin contact \times pin contacts (initial) | | | |
| | Composite removal force | Min. 0.165N/pin contact \times pin contacts | | | |
| Environmental characteristics | Ambient temperature | -55 to +85°C | No icing. No condensation. | | |
| | Soldering heat resistance | The initial specification must be satisfied electrically and mechanically. | Reflow soldering: Peak temperature: 260°C or less (on the surface of the PC board around the connector terminals) Soldering iron: 300°C within 5 sec. 350°C within 3 sec. | | |
| | Storage temperature | -55 to +85°C (product only) -40 to +50°C (emboss packing) | No icing. No condensation. | | |
| | Thermal shock resistance (header and socket mated) | 5 cycles, insulation resistance min. 100M Ω , contact resistance max. 100m Ω | Conformed to MIL-STD-202F, method 107G | | |
| | | | Order | Temperature (°C) | Time (minutes) |
| | | | 1 | -55 $\frac{3}{4}$ | 30 |
| | | | 2 | } | Max. 5 |
| | 3 | 85 $\frac{3}{4}$ | 30 | | |
| 4 | } | Max. 5 | | | |
| 4 | -55 $\frac{3}{4}$ | | | | |
| Humidity resistance (header and socket mated) | 120 hours, insulation resistance min. 100M Ω , contact resistance max. 100m Ω | Conformed to IEC60068-2-78 Temperature 40 \pm 2°C, humidity 90 to 95% R.H. | | | |
| Saltwater spray resistance (header and socket mated) | 24 hours, insulation resistance min. 100M Ω , contact resistance max. 100m Ω | Conformed to IEC60068-2-11 Temperature 35 \pm 2°C, saltwater concentration 5 \pm 1% | | | |
| H ₂ S resistance (header and socket mated) | 48 hours, contact resistance max. 100m Ω | Temperature 40 \pm 2°C, gas concentration 3 \pm 1 ppm, humidity 75 to 80% R.H. | | | |
| Lifetime characteristics | Insertion and removal life | 30 times | Repeated insertion and removal speed of max. 200 times/hours | | |
| Unit weight | | 60 pins Socket: 0.03 g Header: 0.02 g | | | |

2. Material and surface treatment

| Part name | Material | Surface treatment |
|---------------------|---------------------|--|
| Molded portion | LCP resin (UL94V-0) | — |
| Contact and Post | Copper alloy | Contact portion: Base: Ni plating, Surface: Au plating Terminal portion: Base: Ni plating, Surface: Au plating (except the terminal tips) The socket terminals close to the portion to be soldered have nickel barriers (exposed nickel portions). |
| Soldering terminals | Copper alloy | Sockets: Base: Ni plating, Surface: Pd + Au flash plating (except the terminal tips) Headers: Base: Ni plating, Surface: Au plating (except the terminal tips) |

DIMENSIONS (Unit: mm)

The CAD data of the products with a **CAD** mark can be downloaded from: <http://industrial.panasonic.com/ac/e/>

Socket (Mated height: 0.8 mm)

CAD

External dimensions

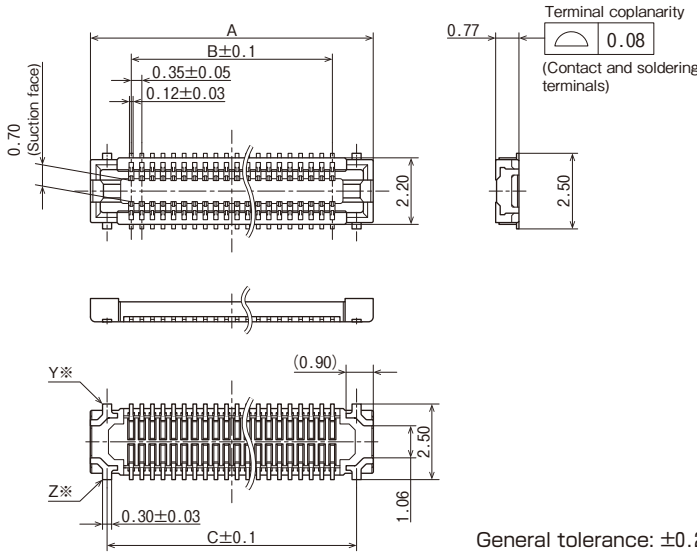

Dimension table

| Number of pins | Dimensions | | |
|----------------|------------|-------|-------|
| | A | B | C |
| 10 | 4.10 | 1.40 | 3.00 |
| 12 | 4.45 | 1.75 | 3.35 |
| 16 | 5.15 | 2.45 | 4.05 |
| 20 | 5.85 | 3.15 | 4.75 |
| 24 | 6.55 | 3.85 | 5.45 |
| 30 | 7.60 | 4.90 | 6.50 |
| 34 | 8.30 | 5.60 | 7.20 |
| 40 | 9.35 | 6.65 | 8.25 |
| 44 | 10.05 | 7.35 | 8.95 |
| 50 | 11.10 | 8.40 | 10.00 |
| 54 | 11.80 | 9.10 | 10.70 |
| 60 | 12.85 | 10.15 | 11.75 |
| 64 | 13.55 | 10.85 | 12.45 |
| 70 | 14.60 | 11.90 | 13.50 |
| 80 | 16.35 | 13.65 | 15.25 |
| 100 | 19.85 | 17.15 | 18.75 |

General tolerance: ±0.2

※Because the soldering terminal Y and Z are the unified structure, they are connected electrically.

Header (Mated height: 0.8 mm)

CAD

External dimensions

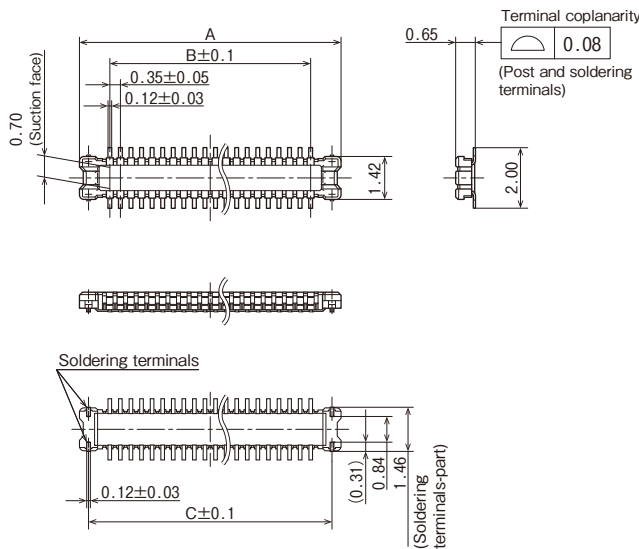

Dimension table

| Number of pins | Dimensions | | |
|----------------|------------|-------|-------|
| | A | B | C |
| 10 | 3.40 | 1.40 | 2.80 |
| 12 | 3.75 | 1.75 | 3.15 |
| 16 | 4.45 | 2.45 | 3.85 |
| 20 | 5.15 | 3.15 | 4.55 |
| 24 | 5.85 | 3.85 | 5.25 |
| 30 | 6.90 | 4.90 | 6.30 |
| 34 | 7.60 | 5.60 | 7.00 |
| 40 | 8.65 | 6.65 | 8.05 |
| 44 | 9.35 | 7.35 | 8.75 |
| 50 | 10.40 | 8.40 | 9.80 |
| 54 | 11.10 | 9.10 | 10.50 |
| 60 | 12.15 | 10.15 | 11.55 |
| 64 | 12.85 | 10.85 | 12.25 |
| 70 | 13.90 | 11.90 | 13.30 |
| 80 | 15.65 | 13.65 | 15.05 |
| 100 | 19.15 | 17.15 | 18.55 |

General tolerance: ±0.2

Socket and Header are mated

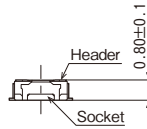

EMBOSSED TAPE DIMENSIONS (Unit: mm)

Specifications for taping

In accordance with JIS C 0806-3:1999. However, not applied to the mounting-hole pitch of some connectors.

Specifications for the plastic reel

In accordance with EIAJ ET-7200B.

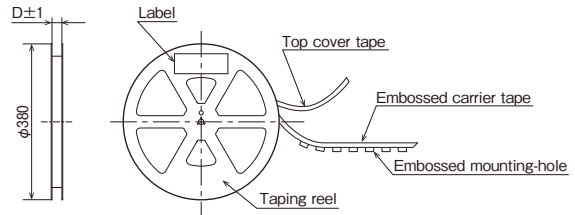
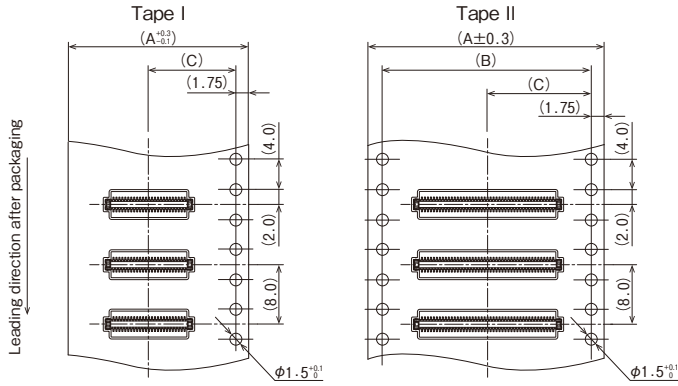

Dimension table

| Type/Mated height | Number of pins | Type of taping | A | B | C | D | Quantity per reel |
|---|----------------|----------------|------|------|------|------|-------------------|
| Common for sockets and headers 0.8mm | 10 to 24 | Tape I | 16.0 | — | 7.5 | 17.4 | 5,000 |
| | 30 to 80 | Tape I | 24.0 | — | 11.5 | 25.4 | 5,000 |
| | 100 | Tape II | 32.0 | 28.4 | 14.2 | 33.4 | 5,000 |

Connector orientation with respect to embossed tape feeding direction

There is no indication on this product regarding top-bottom or left-right orientation.

| Direction of tape progress | Type | Common for A35S | |
|----------------------------|------|-----------------|--------|
| | | Socket | Header |
| ↓ | | | |

| | |
|---|---------------|
| For board-to-FPC | <h1>A35S</h1> |
| Connectors for inspection usage (0.35mm pitch) | |

3,000 mating and unmating cycles Connectors for inspection usage

FEATURES

1. 3,000 mating and unmating cycles
2. Same external dimensions and foot pattern as standard type.
3. Improved mating
Insertion and removal easy due to a reduction in mating retention force. This is made possible by a simple locking structure design.
(Mating retention force cannot be warranted.)
4. Please avoid using for applications other than inspection.

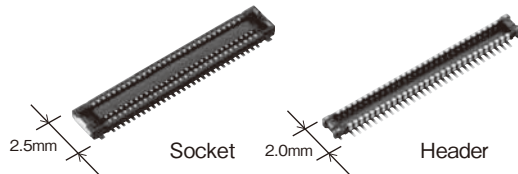

APPLICATIONS

Ideal for module unit inspection and equipment assembly inspection

TABLE OF PRODUCT TYPES

☆: Available for sale

| Product name | Number of pins | | | | | | | | | | | | | | | |
|---------------------|----------------|----|----|----|----|----|----|----|----|----|----|----|----|----|----|-----|
| | 10 | 12 | 16 | 20 | 24 | 30 | 34 | 40 | 44 | 50 | 54 | 60 | 64 | 70 | 80 | 100 |
| A35S for inspection | ☆ | ☆ | ☆ | ☆ | ☆ | ☆ | ☆ | ☆ | ☆ | ☆ | ☆ | ☆ | ☆ | ☆ | ☆ | ☆ |

Notes: 1. Please contact our sales office about availability and number of pins other than those shown above.
2. Please keep the minimum order quantities no less than 50 pieces per lot.

PRODUCT TYPES

| Part No. | |
|-----------|-----------|
| Socket | Header |
| AXE7E**26 | AXE8E**26 |

Note: When placing an order, substitute the "*" (asterisk) in the above part number with the number of pins for the specific connector.

NOTES (Unit: mm)

Design of PC board patterns

Conduct the recommended foot pattern design, in order to preserve the mechanical strength of terminal solder areas.

Recommended PC board and metal mask patterns

Connectors are mounted with high pitch density, intervals of 0.35 mm, 0.4 mm or 0.5 mm. In order to reduce solder and flux rise, solder bridges and other issues make sure the proper levels of solder is used.

The figures are recommended patterns. Please use them as a reference.

Socket (Mated height: 0.8 mm)

Recommended PC board pattern
(TOP VIEW)

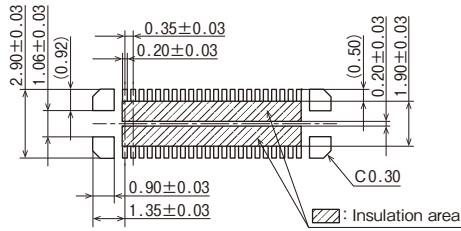

Header (Mated height: 0.8 mm)

Recommended PC board pattern
(TOP VIEW)

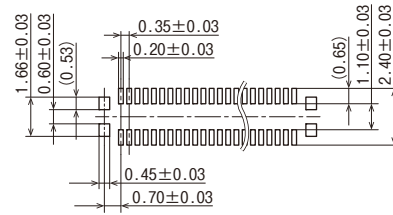

Recommended metal mask pattern

Metal mask thickness: When 120µm
(Terminal opening ratio: 70%)
(Metal-part opening ratio: 70%)

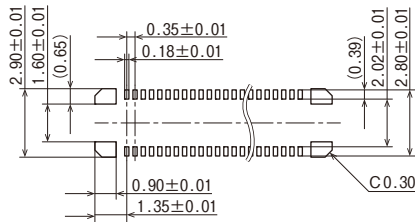

Recommended metal mask pattern

Metal mask thickness: When 120µm
(Terminal opening ratio: 70%)
(Metal-part opening ratio: 100%)

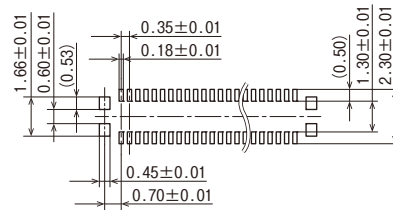

Please refer to the latest product specifications when designing your product.

Notes on Using Narrow pitch Connectors/ High Current Connectors

About safety remarks

Observe the following safety remarks to prevent accidents and injuries.

- 1) Do not use these connectors beyond the specification sheets. The usage outside of specified rated current, dielectric strength, and environmental conditions and so on may cause circuitry damage via abnormal heating, smoke, and fire.
- 2) In order to avoid accidents, your thorough specification review is appreciated. Please contact our sales office if your usage is out of the specifications. Otherwise, Panasonic Corporation cannot guarantee the quality and reliability.

- 3) Panasonic Corporation is consistently striving to improve quality and reliability. However, the fact remains that electrical components and devices generally cause failures at a given statistical probability. Furthermore, their durability varies with use environments or use conditions. In this respect, please check for actual electrical components and devices under actual conditions before use. Continued usage in a state of degraded condition may cause the deteriorated insulation, thus result in abnormal heat, smoke or firing. Please carry out safety design and periodic maintenance including redundancy design, design for fire spread prevention, and design for malfunction prevention so that no accidents resulting in injury or death, fire accidents, or social damage will be caused as a result of failure of the products or ending life of the products.

Regarding the design of devices and PC board patterns

- 1) When using the board to board connectors, do not connect a pair of board with multiple connectors. Otherwise, misaligned connector positions may cause mating failure or product breakage.
- 2) With mounting equipment, there may be up to a ± 0.2 to 0.3 mm error in positioning. Be sure to design PC boards and patterns while taking into consideration the performance and abilities of the required equipment.
- 3) Some connectors have tabs embossed on the body to aid in positioning. When using these connectors, make sure that the PC board is designed with positioning holes to match these tabs.
- 4) To ensure the required mechanical strength when soldering the connector terminals, make sure the PC board meets recommended PC board pattern design dimensions given.
- 5) PC board
Control the thicknesses of the cover lay and adhesive to prevent poor soldering. This connector has no stand-off. Therefore, minimize the thickness of the cover lay, etc. so as to prevent the occurrence of poor soldering.
- 6) For all connectors of the narrow pitch series, to prevent the PC board from coming off during vibrations or impacts, and to prevent loads from falling directly on the soldered portions, be sure to design some means to fix the PC board in place.
Example) Secure in place with screws

- 7) When mounting connectors on a FPC
 - When the connector soldered to FPC is mated or unmated, solder detachment may occur by the force to the terminals. Connector handling is recommended in the condition when the reinforcing plate is attached to the backside of FPC where the connector is mounted. The external dimension of the reinforcing plate is recommended to be larger than the dimension of "Recommended PC board pattern" (extended dimension of one side is approximately 0.5 to 1.0 mm). The materials and thickness of the reinforcing plate are glass epoxy or polyimide (thickness 0.2 to 0.3 mm) or SUS (thickness 0.1 to 0.2 mm).
 - As this connector has temporary locking structure, the connector mating may be separated by the dropping impact depend on the size, weight or bending force of the FPC. Please consider the measures at usage to prevent the mating separation.
- 8) The narrow pitch connector series is designed to be compact and thin. Although ease of handling has been taken into account, take care when mating the connectors, as displacement or angled mating could damage or deform the connector.

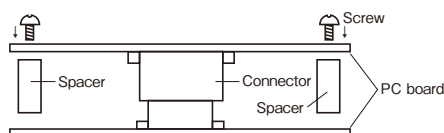

When connecting PC boards, take appropriate measures to prevent the connector from coming off.

Regarding the selection of the connector placement machine and the mounting procedures

- 1) Select the placement machine taking into consideration the connector height, required positioning accuracy, and packaging conditions.
- 2) Be aware that if the chucking force of the placement machine is too great, it may deform the shape of the connector body or connector terminals.
- 3) Be aware that during mounting, external forces may be applied to the connector contact surfaces and terminals and cause deformations.
- 4) Depending on the size of the connector being used, self alignment may not be possible. In such cases, be sure to carefully position the terminal with the PC board pattern.

- 5) The positioning bosses give an approximate alignment for positioning on the PC board. For accurate positioning of the connector when mounting it to the PC board, we recommend using an automatic positioning machine.
- 6) In case of dry condition, please note the occurrence of static electricity. The product may be adhered to the embossed carrier tape or the cover tape in dry condition. Recommended humidity is from 40 to 60%RH and please remove static electricity by ionizer in manufacturing process.

Regarding soldering

Reflow soldering

- 1) Measure the recommended profile temperature for reflow soldering by placing a sensor on the PC board near the connector surface or terminals. (Please refer to the specification for detail because the temperature setting differs by products.)
- 2) As for cream solder printing, screen printing is recommended.
- 3) When setting the screen opening area and PC board foot pattern area, refer the recommended PC board pattern and window size of metal mask on the specification sheet, and make sure that the size of board pattern and metal mask at the base of the terminals are not increased.
- 4) Please pay attentions not to provide too much solder. It makes miss mating because of interference at soldering portion when mating.

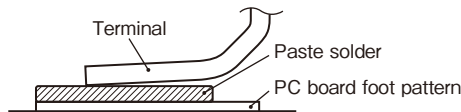

- 5) When mounting on both sides of the PC board and the connector is mounting on the underside, use adhesives or other means to ensure the connector is properly fixed to the PC board. (Double reflow soldering on the same side is possible.)
- 6) The condition of solder or flux rise and wettability varies depending on the type of solder and flux. Solder and flux characteristics should be taken into consideration and also set the reflow temperature and oxygen level.

- 7) Do not use resin-containing solder. Otherwise, the contacts might be firmly fixed.
- 8) Soldering conditions
Please use the reflow temperature profile conditions recommended below for reflow soldering. Please contact our sales office before using a temperature profile other than that described below (e.g. lead-free solder)

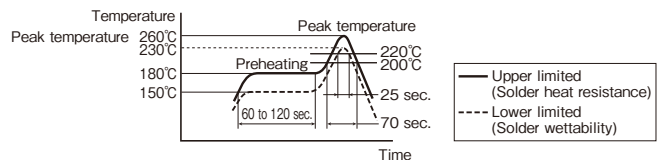

For products other than the ones above, please refer to the latest product specifications.

- 9) The temperature profiles given in this catalog are values measured when using the connector on a resin-based PC board. When performed reflow soldering on a metal board (iron, aluminum, etc.) or a metal table to mount on a FPC, make sure there is no deformation or discoloration of the connector before mounting.
- 10) Please contact our sales office when using a screen-printing thickness other than that recommended.

Hand soldering

- 1) Set the soldering iron so that the tip temperature is less than that given in the table below.

Table A

| Product name | Soldering iron temperature |
|----------------------------------|--|
| SMD type connectors all products | 300°C within 5 sec. 350°C within 3 sec. |

- 2) Do not allow flux to spread onto the connector leads or PC board. This may lead to flux rising up to the connector inside.
- 3) Touch the soldering iron to the foot pattern. After the foot pattern and connector terminal are heated, apply the solder wire so it melts at the end of the connector terminals.

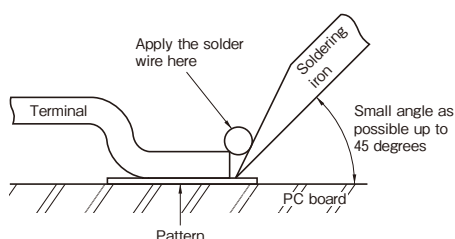

- 4) Be aware that soldering while applying a load on the connector terminals may cause improper operation of the connector.
- 5) Thoroughly clean the soldering iron.
- 6) Flux from the solder wire may get on the contact surfaces during soldering operations. After soldering, carefully check the contact surfaces and clean off any solder before use.
- 7) These connector is low profile type. If too much solder is supplied for hand soldering, It makes miss mating because of interference at soldering portion. Please pay attentions.

Solder reworking

- 1) Finish reworking in one operation.
- 2) In case of soldering rework of bridges. Do not use supplementary solder flux. Doing so may cause contact problems by flux.
- 3) Keep the soldering iron tip temperature below the temperature given in Table A.

Handling single components

- 1) Make sure not to drop or allow parts to fall from work bench.
- 2) Excessive force applied to the terminals could cause warping, come out, or weaken the adhesive strength of the solder. Handle with care.

- 3) Do not insert or remove the connector when it is not soldered. Forcibly applied external pressure on the terminals can weaken the adherence of the terminals to the molded part or cause the terminals to lose their evenness.

Precautions for mating

This product is designed with ease of handling. However, in order to prevent the deformation or damage of contacts and molding, take care and do not mate the connectors as shown right.

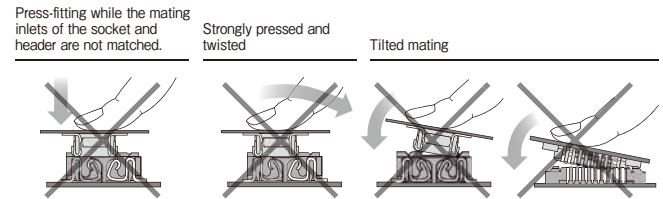

Cleaning flux from PC board

There is no need to clean this product.
If cleaning it, pay attention to the following points to prevent the negative effect to the product.

- 1) Keep the cleaning solvent clean and prevent the connector contacts from contamination.
- 2) Some cleaning solvents are strong and they may dissolve the molded part and characters, so pure water passed liquid solvent is recommended.

Handling the PC board

Handling the PC board after mounting the connector

When cutting or bending the PC board after mounting the connector, be careful that the soldered sections are subjected to excessive force.

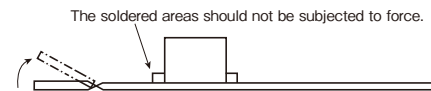

Storage of connectors

- 1) To prevent problems from voids or air pockets due to heat of reflow soldering, avoid storing the connectors in areas of high humidity.
- 2) Depending on the connector type, the color of the connector may vary from connector to connector depending on when it is produced. Some connectors may change color slightly if subjected to ultraviolet rays during storage. This is normal and will not affect the operation of the connector.

- 3) When storing the connectors with the PC boards assembled and components already set, be careful not to stack them up so the connectors are subjected to excessive forces.
- 4) Avoid storing the connectors in locations with excessive dust. The dust may accumulate and cause improper connections at the contact surfaces.

Other Notes

- 1) Do not remove or insert the electrified connector (in the state of carrying current or applying voltage).
- 2) Dropping of the products or rough mishandling may bend or damage the terminals and possibly hinder proper reflow soldering.
- 3) Before soldering, try not to insert or remove the connector more than absolutely necessary.

- 4) When coating the PC board after soldering the connector to prevent the deterioration of insulation, perform the coating in such a way so that the coating does not get on the connector.
- 5) There may be variations in the colors of products from different production lots. This is normal.
- 6) The connectors are not meant to be used for switching.
- 7) Product failures due to condensation are not covered by warranty.

Regarding sample orders to confirm proper mounting

When ordering samples to confirm proper mounting with the placement machine, connectors are delivered in 50-piece units in the condition given right. Consult a sale representative for ordering sample units.

Condition when delivered from manufacturing



Embossed tape amount required for the mounting

Required number of products for sample production (Unit 50 pcs.)

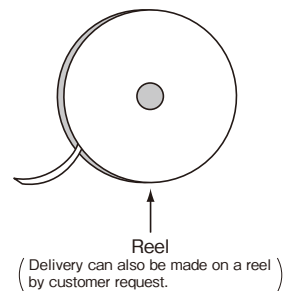

Please refer to the latest product specifications when designing your product.

Please contact

Panasonic Corporation

Electromechanical Control Business Division

■ 1006, Oaza Kadoma, Kadoma-shi, Osaka 571-8506, Japan
industrial.panasonic.com/ac/e/

Panasonic[®]

©Panasonic Corporation 2018

Mouser Electronics

Authorized Distributor

Click to View Pricing, Inventory, Delivery & Lifecycle Information:

Panasonic:

[AXE834124](#) [AXE830124](#) [AXE730127](#) [AXE824124](#) [AXE724127](#) [AXE734127](#) [AXE700124](#) [AXE734124](#)
[AXE750124](#) [AXE800124](#) [AXE730124](#) [AXE810124](#) [AXE812124](#) [AXE820124](#) [AXE840124](#) [AXE860124](#) [AXE712127](#)
[AXE740127](#) [AXE720127](#) [AXE816124](#) [AXE710127](#) [AXE716127](#) [AXE854124](#) [AXE754127](#) [AXE780127](#)
[AXE870124](#) [AXE880124](#) [AXE700127](#) [AXE770127](#)