

SM CONNECTOR

2.5mm pitch/Disconnectable Crimp style wire-to-wire connectors

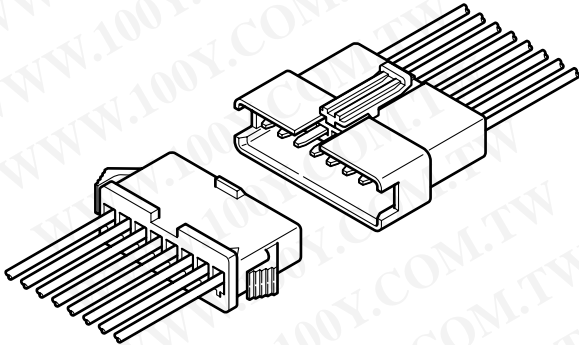

The SM series are 2.5mm pitch, wire-to-wire connectors that perform reliably in high-density, small current applications.

- High contact pressure
- Highly reliable housing construction
- Mountable on a variety of panels
- Arm lock mechanism

Specifications

- Current rating: 3A AC, DC max.
- Voltage rating: 250V AC, DC max.
- Temperature range: -25°C to +85°C (including temperature rise in applying electrical current)
- Contact resistance: Initial value/10m Ω max. After environmental testing/20m Ω max.
- Insulation resistance: 500M Ω min.
- Withstanding voltage: 1,500V AC/minute
- Applicable wire: AWG #28 to #22 0.08 to 0.33mm²
- Applicable panel thickness: 0.5 to 2.0mm
- * Compliant with RoHS.
- * Refer to "General Instruction and Notice when using Terminals and Connectors" at the end of this catalog.
- * Contact JST for details.

Standards

- ☑ Recognized E60389
- ☑ Certified LR20812
- ☑ R50120150

勝特力材料 886-3-5753170
 勝特力电子(上海) 86-21-34970699
 勝特力电子(深圳) 86-755-83298787
[Http://www.100y.com.tw](http://www.100y.com.tw)

Assembly layout

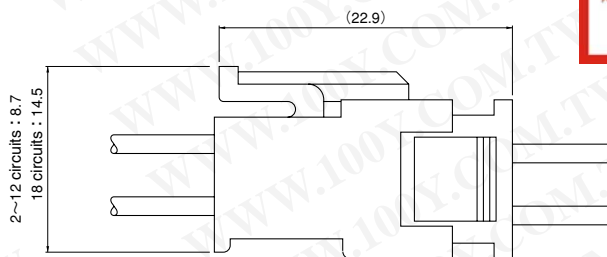

Panel layout

(2 to 12 circuits)

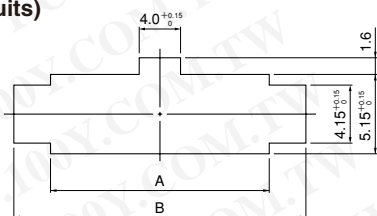

(18 circuits)

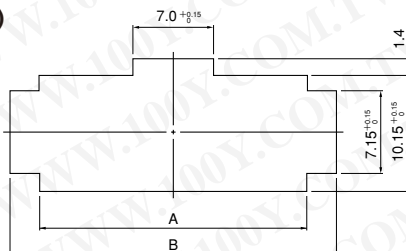

Circuits	Plug housing Model No.	Panel thickness (mm)					
		0.5~0.9		1.0~1.5		1.5~2.0	
		Panel hole dimensions (mm) General tolerance					
		A ^{+0.15}	B ^{±0.1}	A ^{+0.15}	B ^{±0.1}	A ^{+0.15}	B ^{±0.1}
2	SMP-02V-B(N)C	5.7	9.6	5.7	9.8	5.7	10.0
3	SMP-03V-B(N)C	8.2	12.1	8.2	12.3	8.2	12.5
4	SMP-04V-B(N)C	10.7	14.6	10.7	14.8	10.7	15.0
5	SMP-05V-B(N)C	13.2	17.1	13.2	17.3	13.2	17.5
6	SMP-06V-B(N)C	15.7	19.6	15.7	19.8	15.7	20.0
7	SMP-07V-B(N)C	18.2	22.1	18.2	22.3	18.2	22.5
8	SMP-08V-B(N)C	20.7	24.6	20.7	24.8	20.7	25.0
9	SMP-09V-B(N)C	23.2	27.1	23.2	27.3	23.2	27.5
10	SMP-10V-B(N)C	25.7	29.6	25.7	29.8	25.7	30.0
11	SMP-11V-B(N)C	28.2	32.1	28.2	32.3	28.2	32.5
12	SMP-12V-B(N)C	30.7	34.6	30.7	34.8	30.7	35.0
18	SMP-18V-B(N)C	23.2	27.2	23.2	27.4	23.2	27.6

Note: 1. Punch holes in the panel according to the sketch and table shown above. Burrs must be removed.
 2. The strength of the panel must be considered when punching two or more holes.
 3. The connector must be inserted from the same side as the hole is punched.

SM CONNECTOR

Contact

Pin contact

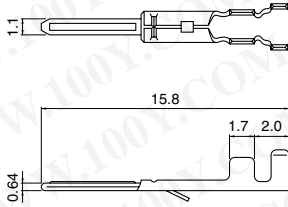

Socket contact

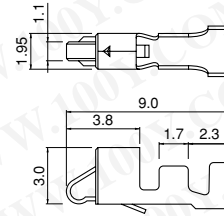

Model No.		Applicable wire		Insulation O.D. (mm)	Q'ty / reel
Pin contact	Socket contact	mm ²	AWG #		
SYM-001T-P0.6	SHF-001T-0.8BS	0.08~0.33	28~22	1.2~1.8	Pin contact: 8,500 Socket contact: 5,000

Material and Finish

Phosphor bronze, tin-plated (reflow treatment)

RoHS compliance

Note: 1. Contact JST for special products.
2. Contact JST for brass products.

Contact	Crimping machine	Applicator		
		Crimp applicator	Dies	Crimp applicator with dies
SYM-001T-P0.6	AP-K2N	MKS-LS·MKS-L	MK/SYM-001-06	APLMK SYM001-06
		*MKS-SC	SC/SYM-001-06	APLSC SYM001-06

Contact	Crimping machine	Applicator		
		Crimp applicator	Dies	Crimp applicator with dies
SHF-001T-0.8BS	AP-K2N	MKS-LS·MKS-L	MK/SHF-001-08S	APLMK SHF001-08S
		*MKS-SC	SC/SHF-001-08S	APLSC SHF001-08S

Note: *Strip-crimp applicator

Contact position location numbers

Contact position numbers are stamped

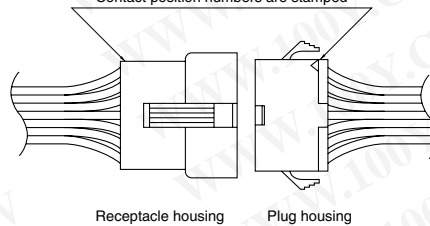

Receptacle housing

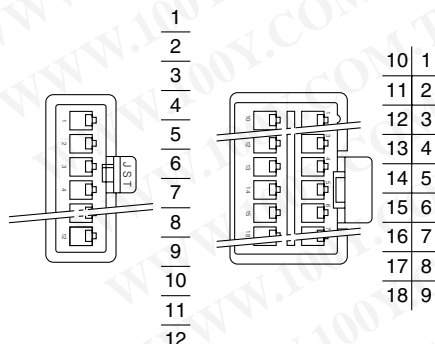

Plug housing

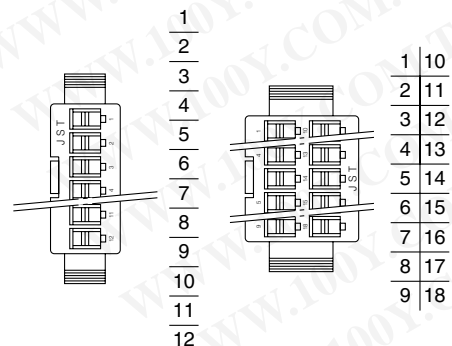

SM CONNECTOR

Housing

Material: PA 6, UL94V-0

Circuits	Current rating	Receptacle housing(for pin contact)		Plug housing(for socket contact)		
2	3A	SMR-02V-B , black SMR-02V-N , white (natural)		Q'ty / bag	SMP-02V-BC , black SMP-02V-NC , white (natural)	Q'ty / bag
			1,000		1,000	
3	3A	SMR-03V-B , black SMR-03V-N , white (natural)		Q'ty / bag	SMP-03V-BC , black SMP-03V-NC , white (natural)	Q'ty / bag
			1,000		1,000	
4	3A	SMR-04V-B , black SMR-04V-N , white (natural)		Q'ty / bag	SMP-04V-BC , black SMP-04V-NC , white (natural)	Q'ty / bag
			500		1,000	
5	3A	SMR-05V-B , black SMR-05V-N , white (natural)		Q'ty / bag	SMP-05V-BC , black SMP-05V-NC , white (natural)	Q'ty / bag
			500		1,000	
6	3A	SMR-06V-B , black SMR-06V-N , white (natural)		Q'ty / bag	SMP-06V-BC , black SMP-06V-NC , white (natural)	Q'ty / bag
			500		500	

RoHS compliance

SM CONNECTOR

Housing

Material: PA 6, UL94V-0

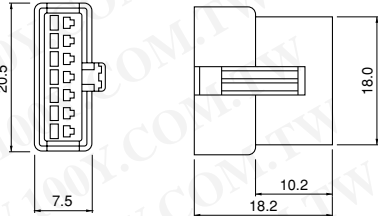
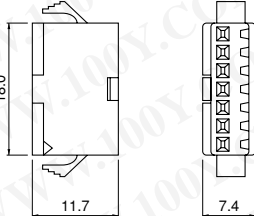
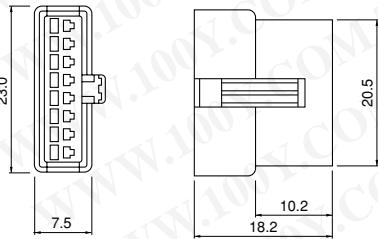
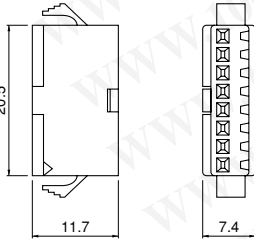
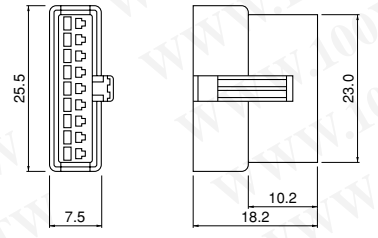
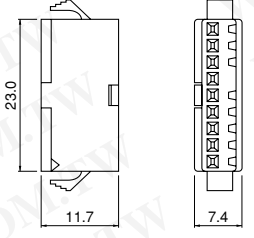
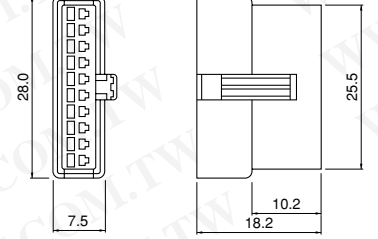
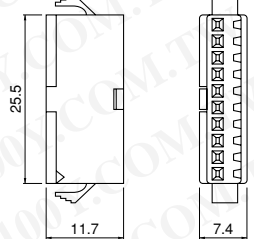
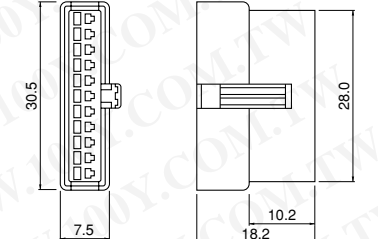
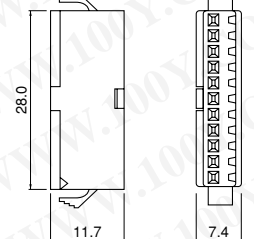
Circuits	Current rating	Receptacle housing(for pin contact)	Plug housing(for socket contact)
7	3A	SMR-07V-B, black SMR-07V-N, white (natural) 	SMP-07V-BC, black SMP-07V-NC, white (natural) Q'ty / bag: 500  Q'ty / bag: 500
8	3A	SMR-08V-B, black SMR-08V-N, white (natural) 	SMP-08V-BC, black SMP-08V-NC, white (natural) Q'ty / bag: 500  Q'ty / bag: 500
9	3A	SMR-09V-B, black SMR-09V-N, white (natural) 	SMP-09V-BC, black SMP-09V-NC, white (natural) Q'ty / bag: 500  Q'ty / bag: 500
10	3A	SMR-10V-B, black SMR-10V-N, white (natural) 	SMP-10V-BC, black SMP-10V-NC, white (natural) Q'ty / bag: 200  Q'ty / bag: 500
11	3A	SMR-11V-B, black SMR-11V-N, white (natural) 	SMP-11V-BC, black SMP-11V-NC, white (natural) Q'ty / bag: 200  Q'ty / bag: 500

RoHS compliance

SM CONNECTOR

Housing

Material: PA 6, UL94V-0

Circuits	Current rating	Receptacle housing(for pin contact)	Q'ty / bag	Plug housing(for socket contact)	Q'ty / bag
12	3A	SMR-12V-B, black SMR-12V-N, white (natural) 	500	SMP-12V-BC, black SMP-12V-NC, white (natural) 	500
18	2A	SMR-18V-B, black SMR-18V-N, white (natural) 	200	SMP-18V-BC, black SMP-18V-NC, white (natural) 	200

RoHS compliance

Note: 1. SM connectors with any number of circuits can be used either panel mounted or free hanging.
 2. Contact JST for special products.