

# VH CONNECTOR

**3.96mm pitch/Disconnectable Crimp style connectors**

勝特力材料 886-3-5753170  
 勝特力电子(上海) 86-21-34970699  
 勝特力电子(深圳) 86-755-83298787  
[Http://www.100y.com.tw](http://www.100y.com.tw)

## Specifications

- Current rating: 10A AC, DC (AWG #16)
- Voltage rating: 250V AC, DC
- Temperature range: -25°C to +85°C  
(including temperature rise in applying electrical current)
- Contact resistance: Initial value/10m Ω max.  
After environmental testing/20m Ω max.
- Insulation resistance: 1,000M Ω min.
- Withstanding voltage: 1,500V AC/minute
- Applicable wire: AWG #22 to #16
- Applicable PC board thickness: 1.6mm

### Note:

Do not branch in parallel current which exceeds the rated current. If branched in parallel, current imbalance or other problems may develop. If it is absolutely necessary to branch such a large current in parallel, be sure to use contacts made of phosphor bronze. Design the circuits without causing imbalance and provide an extra margin for each circuit.

- \* Compliant with RoHS.
- \* Refer to "General Instruction and Notice when using Terminals and Connectors" at the end of this catalog.
- \* Contact JST for details.

## Standards

- Ⓜ Recognized E60389
- Ⓢ Certified LR20812
- Ⓡ R75122

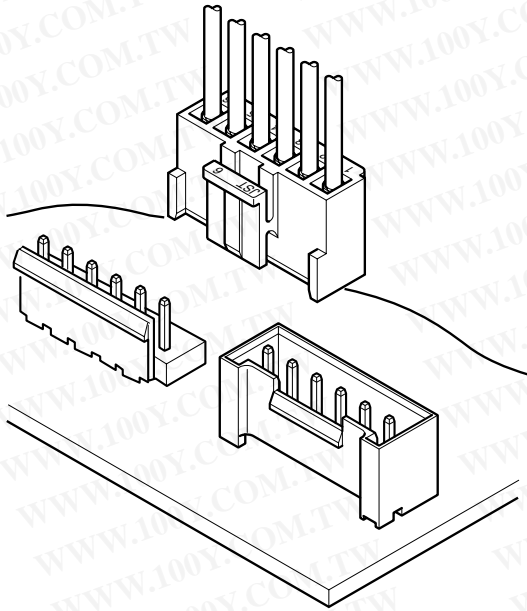

**This small, field-proven connector for printed circuit boards is reliable and has a large current carrying capacity. It can be used with a wide variety of signal, power supply, and output circuits that appear in consumer electronic products.**

- Proven box contact
- Compact connector with a large capacity
- Secure contact and mounting

## PC board layout (viewed from soldering side) and Assembly layout

### Locking header Top entry type

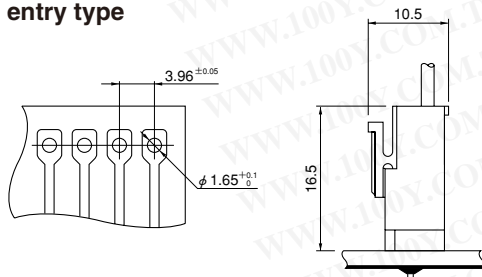

### Locking header Side entry type

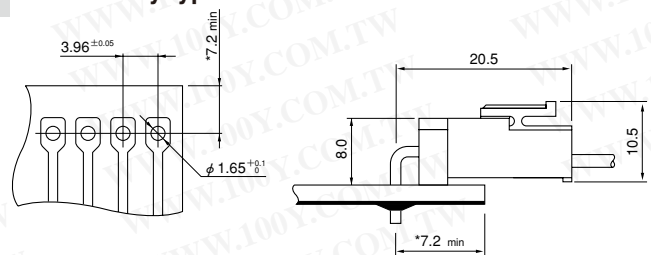

\*11.0 max. when used with the VR connector receptacle.

### Locking header Side entry type with PCB stabilizer

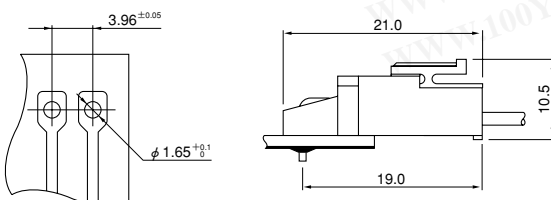

### Shrouded header

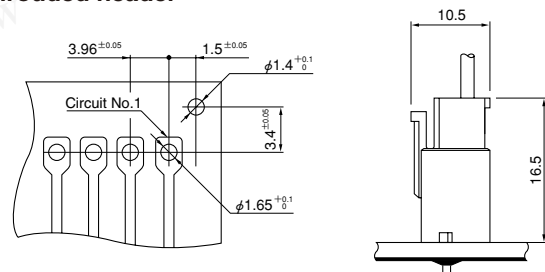

Note: 1. Tolerances are non-cumulative: ±0.05mm for all centers.

2. Please consider the pattern layout design in case of applying the large current.

3. Hole dimensions differ according to the kind of PC board and piercing method. The dimensions above should serve as a guideline. Contact JST for details.

# VH CONNECTOR

## Contact

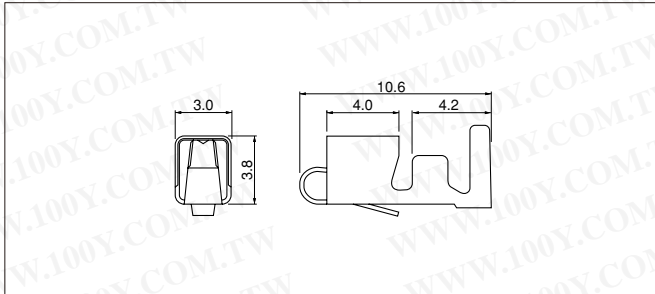

Model No.	Applicable wire		Insulation O.D. (mm)	Q'ty / reel
	mm <sup>2</sup>	AWG#		
SVH-21T-P1.1	0.33~0.83	22~18	1.7~3.0	4,500
SVH-41T-P1.1	0.5 ~1.25	20~16	1.7~3.0	3,500

### Material and Finish

Phosphor bronze, tin-plated (reflow treatment)

### RoHS compliance

Note: 1. Contact JST for brass products.

2. When using retainer mountable type housing, applicable wire's insulation O. D. shall be 1.7 to 2.2mm.

Contact	Crimping machine	Applicator		
		Crimp applicator	Dies	Crimp applicator with dies
SVH-21T-P1.1	AP-K2N	MKS-L	MK/SVH-21-11	APLMK SVH21-11
		*MKS-SC	SC/SVH-21-11	APLSC SVH21-11

Contact	Crimping machine	Applicator		
		Crimp applicator	Dies	Crimp applicator with dies
SVH-41T-P1.1	AP-K2N	MKS-L	MK/SVH-41-11	APLMK SVH41-11
		—	—	—

Note: \*Strip-crimp applicator

## Housing

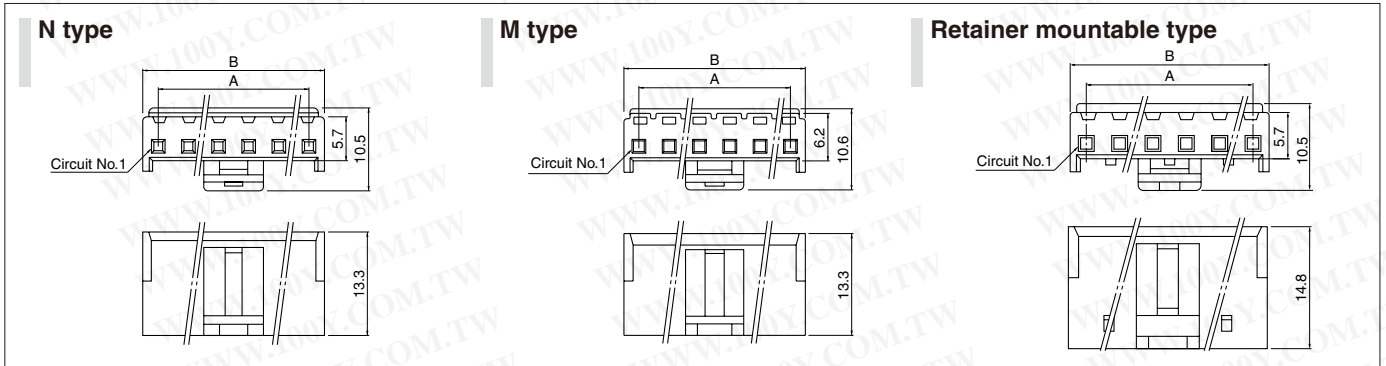

Circuits	Model No.			Dimensions (mm)		Q'ty / bag
	N type	M type	Retaine mountable type	A	B	
2	VHR-2N	VHR-2M	*VHRR-2N	3.96	7.86	1,000
3	VHR-3N	VHR-3M	*VHRR-3N	7.92	11.82	1,000
4	VHR-4N	VHR-4M	—	11.88	15.78	1,000
5	VHR-5N	VHR-5M	*VHRR-5N	15.84	19.74	1,000
6	VHR-6N	VHR-6M	—	19.80	23.70	500
7	VHR-7N	VHR-7M	*VHRR-7N	23.76	27.66	500
8	VHR-8N	—	*VHRR-8N	27.72	31.62	500
9	VHR-9N	VHR-9M	*VHRR-9N	31.68	35.58	500
10	VHR-10N	—	—	35.64	39.54	500
11	*VHR-11N	—	—	39.60	43.50	500

### Material

PA 6, UL94V-0, natural (white)

RoHS compliance

Note: 1. Models identified as VHR-( ) M incorporate measures to prevent electric shock and are thus safer in regard to high voltages.  
2. The applicable housing for 2 circuits shrouded header is "VHR-2N" only. "VHRR-2N" is not applicable.  
3. \*Marked products are not TÜV approved.

<For reference> As the color identification, the following alphabet shall be put in the underlined part.  
For availability, delivery and minimum order quantity, contact JST.

ex. **VHR-2N-oo**

(blank)...natural (white)

BK...black R...red

BL...blue M...green

D...orange Y...yellow

PK...pink H...gray

## Retainer

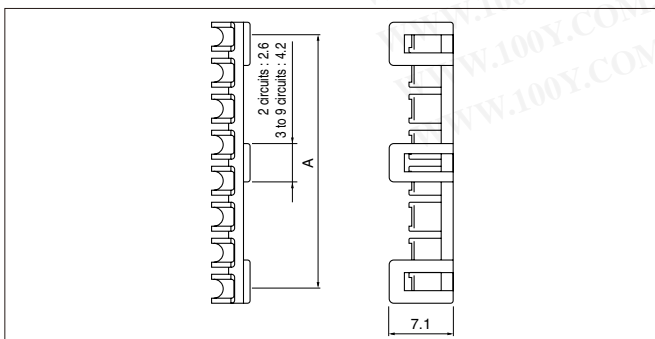

Circuits	Model No.	A	Q'ty / bag
2	VHS-2V	3.70	1,000
3	VHS-3V	7.52	1,000
5	VHS-5V	15.44	1,000
7	VHS-7V	23.36	1,000
8	VHS-8V	27.32	1,000
9	VHS-9V	31.28	1,000

### Material

Glass-filled PA 66, UL94V-0, natural (ivory)

### RoHS compliance

Note: Not TÜV approved.

# VH CONNECTOR

## Locking header

### Top entry type

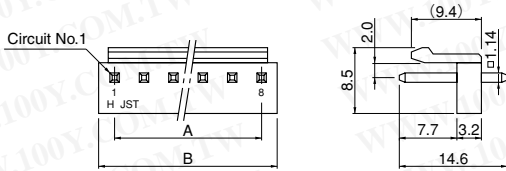

### Side entry type

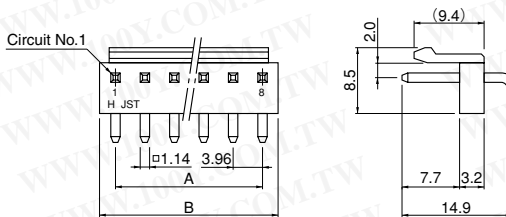

Circuits	Model No.		Dimensions (mm)		Q'ty / box	
	Top entry type	Side entry type	A	B	Top entry type	Side entry type
2	<b>B2P-VH</b>	<b>B2PS-VH</b>	3.96	7.86	1,000	1,000
3	<b>B3P-VH</b>	<b>B3PS-VH</b>	7.92	11.82	1,000	500
4	<b>B4P-VH</b>	<b>B4PS-VH</b>	11.88	15.78	500	500
5	<b>B5P-VH</b>	<b>B5PS-VH</b>	15.84	19.74	500	250
6	<b>B6P-VH</b>	<b>B6PS-VH</b>	19.80	23.70	250	250
7	<b>B7P-VH</b>	<b>B7PS-VH</b>	23.76	27.66	250	250
8	<b>B8P-VH</b>	<b>B8PS-VH</b>	27.72	31.62	200	200
9	<b>B9P-VH</b>	<b>B9PS-VH</b>	31.68	35.58	200	200
10	<b>B10P-VH</b>	<b>B10PS-VH</b>	35.64	39.54	200	100

### Material and Finish

Post: Brass, copper-undercoated, tin-plated (reflow treatment)  
Wafer: PA 66 UL94V-0, natural (white)

**RoHS compliance** This product displays (LF)(SN) on a label.  
Note: Headers with a reduced number of posts are also available.  
Contact JST for details.

<For reference> As the color identification, the following alphabet shall be put in the underlined part.  
For availability, delivery and minimum order quantity, contact JST.

ex. **B2P(S)-VH-oo**

(blank)...natural (white)

BK...black R...red TR...tomato red BL...blue M...green

O...orange Y...yellow PK...pink H...gray

### Top entry type of PBT

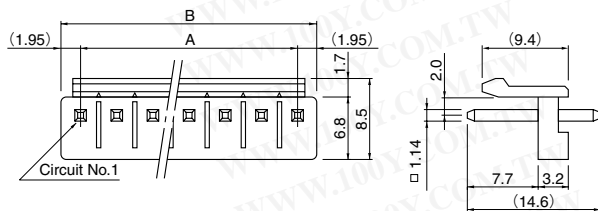

### Side entry type with PCB stabilizer

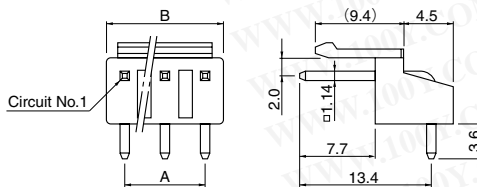

Circuits	Model No.		Dimensions (mm)		Q'ty / box	
	Top entry type of PBT	Side entry type with PCB stabilizer	A	B	Top entry type	Side entry type
2	<b>B2P-VH-B</b>	<b>S2P-VH</b>	3.96	7.86	1,000	1,000
3	<b>B3P-VH-B</b>	<b>S3P-VH</b>	7.92	11.82	1,000	500
4	<b>B4P-VH-B</b>	<b>S4P-VH</b>	11.88	15.78	500	500
5	<b>B5P-VH-B</b>	<b>S5P-VH</b>	15.84	19.74	500	250
6	<b>B6P-VH-B</b>	<b>S6P-VH</b>	19.80	23.70	250	250
7	<b>B7P-VH-B</b>	<b>S7P-VH</b>	23.76	27.66	250	250
8	<b>B8P-VH-B</b>	—	27.72	31.62	200	—
9	<b>B9P-VH-B</b>	—	31.68	35.58	200	—
10	<b>B10P-VH-B</b>	—	35.64	39.54	200	—
11	<b>B11P-VH-B</b>	—	39.60	43.50	200	—

### Material and Finish

Post: Brass, copper-undercoated, tin-plated (reflow treatment)  
Wafer: Top entry type of PBT: Glass-filled PBT, UL94V-0, natural (white)  
Side entry type with PCB stabilizer: PA 66, UL94V-0, natural (white)

**RoHS compliance** This product displays (LF)(SN) on a label.  
Note: \*Marked product is not TÜV approved.

<For reference> As the color identification, the following alphabet shall be put in the underlined part.  
For availability, delivery and minimum order quantity, contact JST.

<Top entry type of PBT>

ex. **B2P-VH-B-oo**

(blank)...natural (white)

C...black R...red E...blue M...green Y...yellow

<Side entry type with PCB stabilizer>

ex. **S2P-VH-oo**

(blank)...natural (white)

BK...black R...red BL...blue Y...yellow M...green

# VH CONNECTOR

## Shrouded header

(2, 3 circuits)

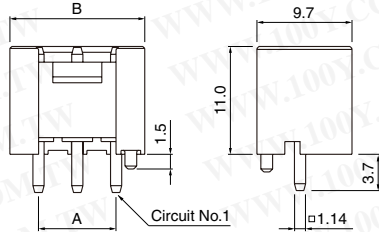

(4 to 10 circuits)

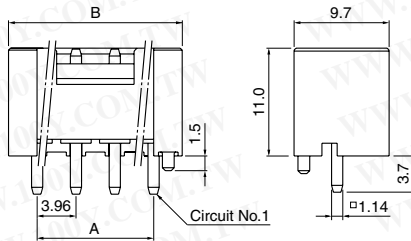

Circuits	Model No.	Dimensions (mm)		Q'ty / box
		A	B	
2	<b>B2P-VH-FB-B</b>	3.96	9.80	250
3	<b>B3P-VH-FB-B</b>	7.92	13.76	200
4	<b>B4P-VH-FB-B</b>	11.88	17.72	150
5	<b>B5P-VH-FB-B</b>	15.84	21.68	200
6	<b>B6P-VH-FB-B</b>	19.80	25.64	200
7	<b>B7P-VH-FB-B</b>	23.76	29.60	100
8	<b>B8P-VH-FB-B</b>	27.72	33.56	100
9	<b>B9P-VH-FB-B</b>	31.68	37.52	100
10	<b>B10P-VH-FB-B</b>	35.64	41.48	125

### Material and Finish

Post: Copper alloy, copper-undercoated, tin-plated (reflow treatment)  
Wafer: Glass-filled PBT, UL94V-0, natural (white)

**RoHS compliance** This product displays (LF)(SN) on a label.

Note: The applicable housing for 2 circuits shrouded header is "VHR-2N" only.  
"VHRR-2N" is not applicable.

<For reference> As the color identification,  
the following alphabet shall be put in the underlined part.  
For availability, delivery and minimum order quantity, contact JST.

ex. **B2P-VH-FB-B-oo**

(blank)...natural (white)

R...red C...black E...blue M...green Y...yellow O...orange

H...gray PK...pink



# VH CONNECTOR (High box type)

## 3.96mm pitch/Disconnectable Crimp style connectors

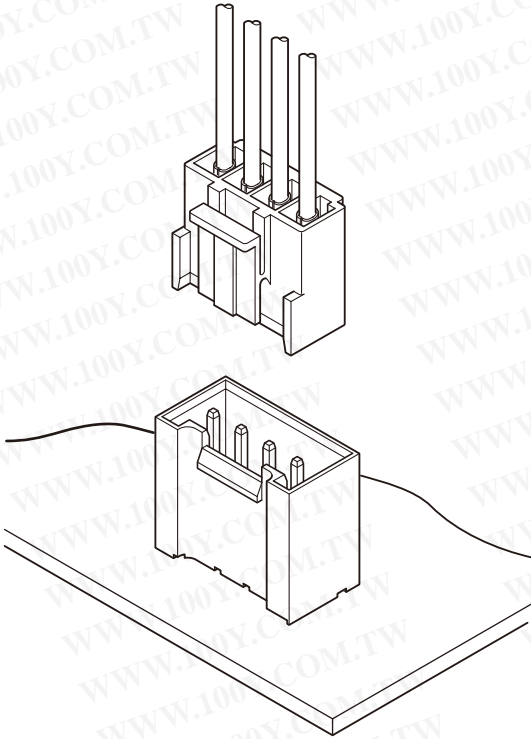

**Header for 3.96mm pitch VH connector for use specifically with resin coated ("potted") PC boards.**

### • Interchangeability

## Specifications

- Current rating: 7A AC, DC (AWG #18)  
10A AC, DC (AWG #16)/1 circuit only
- Voltage rating: 250V AC, DC
- Temperature range: -25°C to +85°C  
(including temperature rise in applying electrical current)
- Contact resistance: Initial value/10m Ω max.  
After environmental testing/20m Ω max.
- Insulation resistance: 1,000M Ω min.
- Withstanding voltage: 1,500V AC/minute
- Applicable wire: AWG #22 to #16
- Applicable PC board thickness: 1.6mm

*Note: Do not branch in parallel current which exceeds the rated current. If branched in parallel, current imbalance or other problems may develop. If it is absolutely necessary to branch such a large current in parallel, be sure to use contacts made of phosphor bronze. Design the circuits without causing imbalance and provide an extra margin for each circuit.*

- \* Compliant with RoHS.
- \* Refer to "General Instruction and Notice when using Terminals and Connectors" at the end of this catalog.
- \* Contact JST for details.

## Standards

Recognized E60389

Certified LR20812

R75122

## PC board layout (viewed from soldering side) and Assembly layout

### 1 circuit

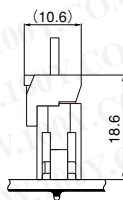
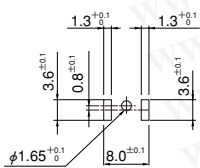

### 2 to 8 circuits

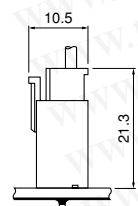
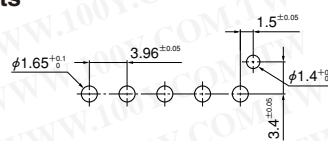

*Note: 1. Tolerances are non-cumulative: ±0.05mm for all centers.*

*2. Hole dimensions differ according to the kind of PC board and piercing method. The dimensions above should serve as a guide line. Contact JST for details.*

## Contact

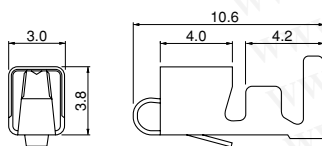

Model No.	Applicable wire		Insulation O.D. (mm)	Q'ty / reel
	mm <sup>2</sup>	AWG#		
SVH-21T-P1.1	0.33~0.83	22~18	1.7~3.0	4,500
*SVH-41T-P1.1	0.5 ~1.25	20~16	1.7~3.0	3,500

### Material and Finish

Phosphor bronze, tin-plated (reflow treatment)

### RoHS compliance

*Note: 1. \*The current rating when combining with 1 circuit is 10A AC, DC (AWG #16.)*

*2. Contact JST for brass product.*

Contact	Crimping machine	Applicator		
		Crimp applicator	Dies	Crimp applicator with dies
SVH-21T-P1.1	AP-K2N	MKS-L	MK/SVH-21-11	APLMK SVH21-11
		*MKS-SC	SC/SVH-21-11	APLSC SVH21-11

Contact	Crimping machine	Applicator		
		Crimp applicator	Dies	Crimp applicator with dies
SVH-41T-P1.1	AP-K2N	MKS-L	MK/SVH-41-11	APLMK SVH41-11
		-	-	-

*Note: \*Strip-crimp applicator*

# VH CONNECTOR (High box type)

## Housing

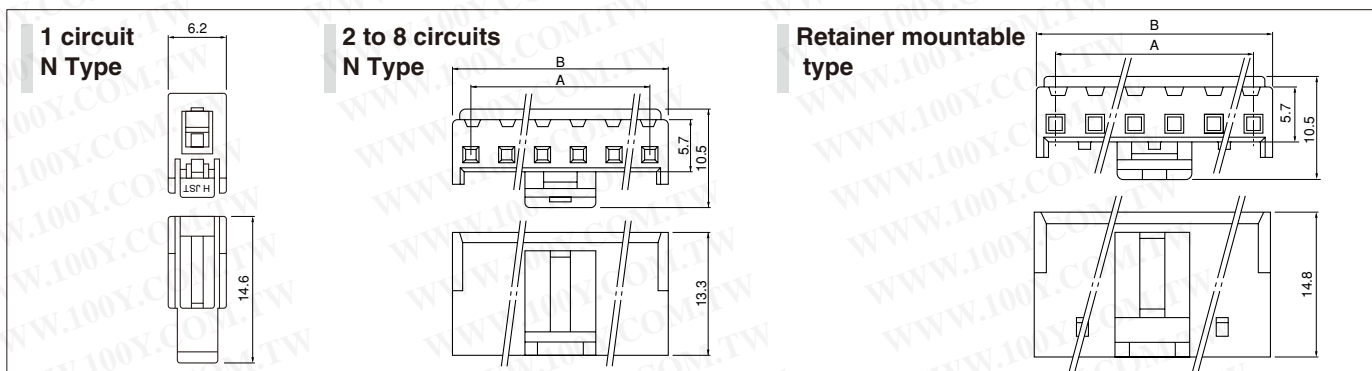

Circuits	Model No.		Dimensions (mm)		Q'ty / bag
	N type	Retainer mountable type	A	B	
1	*VHR-1N	—	—	—	1,000
2	VHR-2N	—	3.96	7.86	1,000
3	VHR-3N	*VHRR-3N	7.92	11.82	1,000
4	VHR-4N	—	11.88	15.78	1,000
5	VHR-5N	*VHRR-5N	15.84	19.74	1,000
6	VHR-6N	—	19.80	23.70	500
7	VHR-7N	*VHRR-7N	23.76	27.66	500
8	VHR-8N	*VHRR-8N	27.72	31.62	500

Material
PA 6, UL94V-0, natural (white)

### RoHS compliance

Note: \*Marked products are not TÜV approved.  
 <For reference> As the color identification, the following alphabet shall be put in the underlined part.  
 For availability, delivery and minimum order quantity, contact JST.

ex. **VHR-2N-oo**  
 (blank)...natural (white)  
 BK...black R...red BL...blue M...green

## Retainer

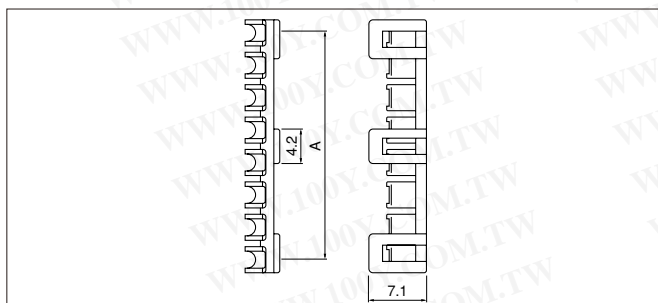

Circuits	Model No.	A	Q'ty / bag
2	VHS-2V	3.70	1,000
3	VHS-3V	7.52	1,000
5	VHS-5V	15.44	1,000
7	VHS-7V	23.36	1,000
8	VHS-8V	27.32	1,000
9	VHS-9V	31.28	1,000

Material
Glass-filled PA 66, UL94V-0, natural (ivory)

### RoHS compliance

Note: Not TÜV approved.

## Shrouded header

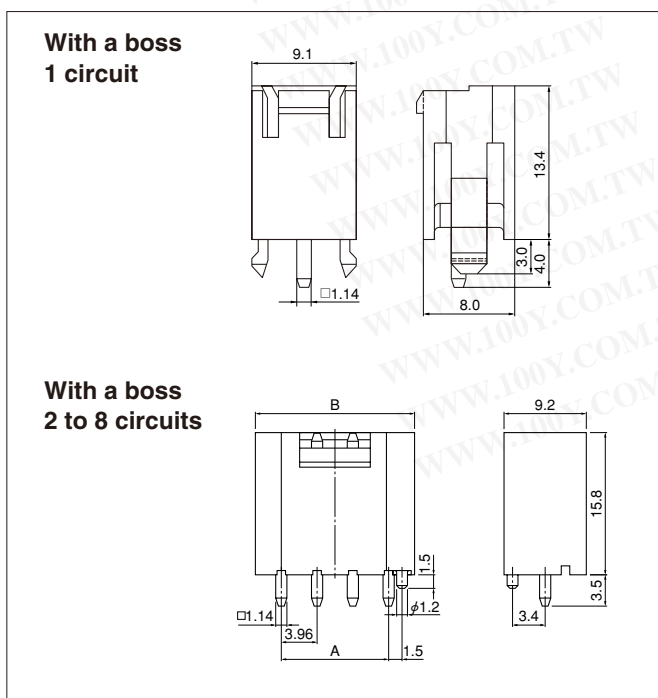

Circuits	Model No.	Q'ty / box
1	BH1P-VH-1	500

Material and Finish
Post: Brass, copper-undercoated, tin-plated (reflow treatment) Wafer: PA 66, UL-94V-0, natural (white)

**RoHS compliance** This product displays (LF)(SN) on a label.  
 Note: Not TÜV approved.

Circuits	Model No.	Dimensions (mm)		Q'ty / box
		A	B	
2	BH2P-VH-1	3.96	9.80	250
3	BH3P-VH-1	7.92	13.76	200
4	BH4P-VH-1	11.88	17.72	150
5	BH5P-VH-1	15.84	21.68	100
6	BH6P-VH-1	19.80	25.64	100
7	BH7P-VH-1	23.76	29.60	100
8	BH8P-VH-1	27.72	33.56	100

Material and Finish
Post: Brass, copper-undercoated, tin-plated (reflow treatment) Wafer: Glass-filled PA 66, UL-94V-0, natural (ivory)

**RoHS compliance** This product displays (LF)(SN) on a label.

<For reference> As the color identification, the following alphabet shall be put in the underlined part.  
 For availability, delivery and minimum order quantity, contact JST.

ex. **BH2P-VH-1-oo**  
 (blank)...natural (ivory) BK...black R...red BL...blue M...green