



产品编号 : [10112093](#)

Product Description : KK 254 Crimp Housing, High Pressure, 9 Circuits, Natural

系列号 : 7880

状态 : Active

Product Category : Connector Housings

工程编号 : 7880-09B



文件和资源

图纸

[图纸 010112093_sd.pdf](#)

3D 模型和设计文件

[3D模型 010112093_stp.zip](#)

规格

[产品规格 PS-7879-001.pdf](#)

产物环境合规

合规

GADSL/IMDS	Not Relevant
China RoHS	
EU ELV	Not Relevant
Low-Halogen Status	Low-Halogen per IEC 61249-2-21
REACH SVHC	Not Contained per D(2023)3788-DC (14 Jun 2023)
EU RoHS	Compliant per EU 2015/863

[多部分产品合规性声明](#)

- Eu RoHS
- REACH SVHC
- Low-Halogen

[多部分行业合规性文件](#)

- IPC 1752A Class C
- IPC 1752A Class D
- Molex Product Compliance Declaration
- IEC-62474
- chemSHERPA (xml)

欧盟 RoHS 合格证书

产品详情

常规

状态	活动
类别	Connector Housings
系列	7880
说明	KK 254 Crimp Housing, High Pressure, 9 Circuits, Natural
应用	Signal, Wire-to-Board
产品系列	KK Interconnect Systems
产品名称	KK 254
UPC	800754241434

机构

CSA	LR19980
UL	E29179

物理

电路数（最多）	9
颜色-树脂	Natural (White)
阻燃性	94V-0
性别	Receptacle
符合灼热丝规范	否
材料 - 树脂	Nylon
净重	0.882/g
行数	1
包装形式	Bag
面板安装式	否
间距 - 插配接口	2.54mm

间距 - 终端界面	2.54mm
可堆叠的	否
运行温度范围	See Product Specification

进程

无铅	不适用
----	-----

可配插/可连接使用的产品

可配插部件

描述	产品编号
KK 254 Single Row Vertical Headers	<u>4030</u>
KK 254 Vertical Breakaway Headers with Friction Lock	<u>42375</u>
KK 254 Right-Angle Breakaway Headers	<u>42376</u>
KK 254 Right-Angle Surface Mount Compatible Breakaway Headers	<u>42377</u>
KK 254 Vertical Single Row Solid Headers	<u>6373</u>
KK 254 Vertical Single Row Headers	<u>6410</u>

可连接使用部件

描述	产品编号
KK High Pressure Female Crimp Terminals	<u>7879</u>

NO. OF CKT'S.	DIM. A	DIM. B
2	.100±.004 (2.54±.10)	.222±.010 (5.64±.25)
3	.200±.004 (5.08±.10)	.322±.010 (8.18±.25)
4	.300±.004 (7.62±.10)	.422±.010 (10.72±.25)
5	.400±.004 (10.16±.10)	.522±.010 (13.26±.25)
6	.500±.005 (12.70±.13)	.622±.010 (15.80±.25)
7	.600±.005 (15.24±.13)	.722±.011 (18.34±.28)
8	.700±.005 (17.78±.13)	.822±.011 (20.88±.28)
9	.800±.006 (20.32±.15)	.922±.011 (23.42±.28)
10	.900±.006 (22.86±.15)	1.022±.012 (25.96±.30)
11	1.000±.006 (25.40±.15)	1.122±.012 (28.50±.30)
12	1.100±.006 (27.94±.15)	1.222±.012 (31.04±.30)
13	1.200±.007 (30.48±.18)	1.322±.012 (33.58±.30)
14	1.300±.007 (33.02±.18)	1.422±.013 (36.12±.33)
15	1.400±.011 (35.56±.28)	1.522±.013 (38.66±.33)
16	1.500±.011 (38.10±.28)	1.622±.013 (41.20±.33)
17	1.600±.011 (40.64±.28)	1.722±.013 (43.74±.33)
18	1.700±.011 (43.18±.28)	1.822±.014 (46.28±.36)

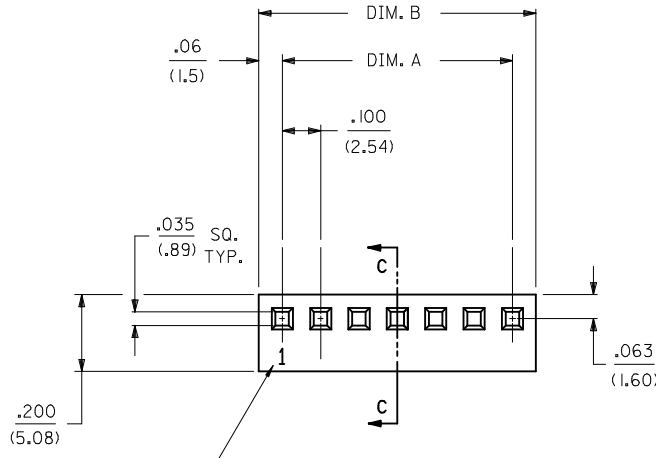

CIRCUIT 1 I.D. MAY OR MAY NOT BE PRESENT ON 2 CIRCUIT HOUSINGS SEE NOTE 10

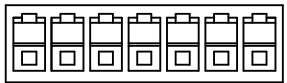
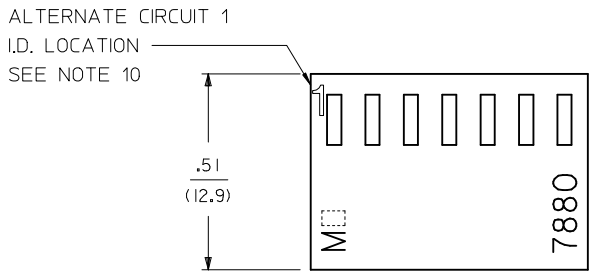

- NOTES:
1. MATERIAL: NYLON, UL94V-0, COLOR: WHITE
 2. FINISH: N/A
 3. PRODUCT SPECIFICATION: PS-7879
 4. PACKAGING SPECIFICATION: PK-7880-001.
 5. INSERTION AND WITHDRAWAL FORCES RANGE FROM 1.3 - 1.9 LBS/ (5.8 - 8.5N) PER CIRCUIT.
 6. DIMENSIONS GIVEN ACROSS CENTERLINES ARE SYMMETRICAL ABOUT THOSE CENTERLINES WITHIN HALF THE TOTAL TOLERANCE.
 7. THIS HOUSING FOR USE WITH SHROUDED TERMINAL SERIES 7879.
 8. THIS PART CONFORMS TO CLASS B REQUIREMENTS OF COSMETIC SPECIFICATION PS-45499-002.
 9. SPECIAL SUPPORT MAY BE REQUIRED FOR PRINTED CIRCUIT BOARDS USED WITH 10 OR MORE CIRCUIT CONNECTORS.
 10. CIRCUIT 1 ID LOCATION IS DETERMINED BY TOOLING AND WILL BE PRESENT IN ONE OF THE LOCATIONS SHOWN EXCEPT WHERE INDICATED.
 11. THE PARTS LISTED ON THIS DRAWING ARE CONSTRUCTED TO MEET THE REQUIREMENT FOR DIRECT SUPPORT OF UNINSULATED LIVE PARTS AS DESCRIBED IN UL508C.

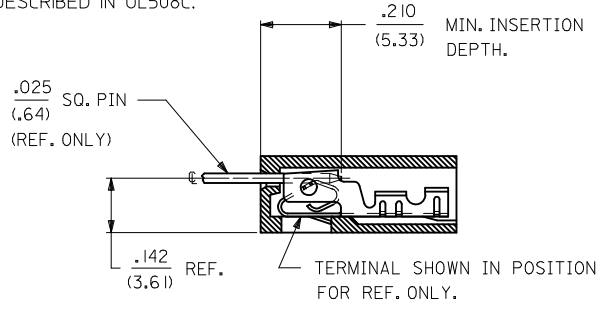

SECTION C-C

7880 - N *
NO. OF CKTS.

OPTION CODE	
OPT. CODE	RAMP
A	NONE
B	STD. RAMP
C	POL. RAMP

ADD NOTE 10 & 11 EC NO: UCP2017-1789 DRWING: APPELDORN 2017/02/16 CHKD: HK/IPPER 2017/02/16 APPR: FSM/LTH 2017/02/17	QUALITY SYMBOLS ▽=0 ▽=0 ▽=0	GENERAL TOLERANCES (UNLESS SPECIFIED)		DIMENSION STYLE IN/MM		SCALE	DESIGN UNITS INCH	THIRD ANGLE PROJECTION		
				mm	INCH	DRAWN BY GUZIK	DATE 1988/08/24	.100/(2.54) KK HOUSING FOR SHROUDED CRIMP TERMINAL		
				4 PLACES ± --- ± ---	3 PLACES ± --- ± .010	CHECKED BY PATEL	DATE 1988/08/24			
				2 PLACES ± 0.25 ± .014	1 PLACE ± 0.35 ± ---	APPROVED BY		MOLEX INCORPORATED		SHEET NO. 1 OF 2
		ANGULAR ±1/2°		MATERIAL NO. SEE CHART		DOCUMENT NO. SD-7880				
		DRAFT WHERE APPLICABLE MUST REMAIN WITHIN DIMENSIONS		SIZE C		THIS DRAWING CONTAINS INFORMATION THAT IS PROPRIETARY TO MOLEX INCORPORATED AND SHOULD NOT BE USED WITHOUT WRITTEN PERMISSION				

7880-NA-*	
PART NO.	ENG. NO
10-01-2029	7880-2A
10-01-2039	7880-3A
10-01-2049	7880-4A
10-01-2059	7880-5A
10-01-2069	7880-6A
10-01-2079	7880-7A
10-01-2089	7880-8A
10-01-2099	7880-9A
10-01-2109	7880-10A
10-01-2119	7880-11A
10-01-2129	7880-12A
10-01-2139	7880-13A
10-01-2149	7880-14A
10-01-2159	7880-15A
10-01-2169	7880-16A
10-01-2179	7880-17A
10-01-2189	7880-18A

7880-NB-*	
PART NO.	ENG. NO
10-11-2023	7880-2B
10-11-2033	7880-3B
10-11-2043	7880-4B
10-11-2053	7880-5B
10-11-2063	7880-6B
10-11-2073	7880-7B
10-11-2083	7880-8B
10-11-2093	7880-9B
10-11-2103	7880-10B
10-11-2113	7880-11B
10-11-2123	7880-12B
10-11-2133	7880-13B
10-11-2143	7880-14B
10-11-2153	7880-15B
10-11-2163	7880-16B
10-11-2173	7880-17B
10-11-2183	7880-18B

7880-NC-*	
PART NO.	ENG. NO
10-11-2024	7880-2C
10-11-2034	7880-3C
10-11-2044	7880-4C
10-11-2054	7880-5C
10-11-2064	7880-6C
10-11-2074	7880-7C
10-11-2084	7880-8C
10-11-2094	7880-9C
10-11-2104	7880-10C
10-11-2114	7880-11C
10-11-2124	7880-12C
10-11-2134	7880-13C
10-11-2144	7880-14C
10-11-2154	7880-15C
10-11-2164	7880-16C
10-11-2174	7880-17C
10-11-2184	7880-18C

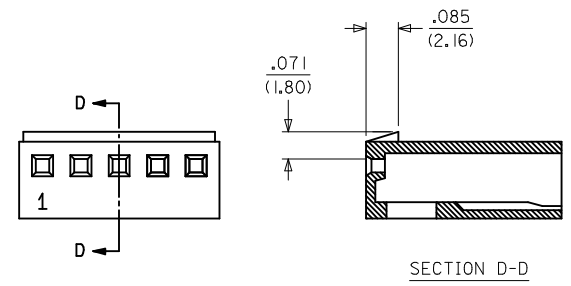

7880-NB-
STD. RAMP OPTION

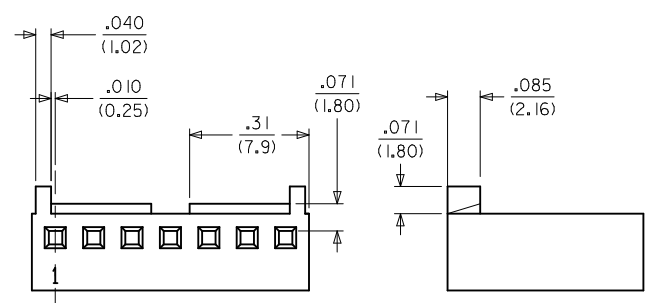

NOTE: 2 THRU 6 CKT PARTS HAVE A SOLID RAMP

7880-NC-
POLARIZING RAMP OPTION

WHEN MATING 7880-NC-
TO BREAKAWAY FRICTION
LOCK OR POLARIZING
HEADERS, THE END BACKWALLS
MUST BE REMOVED

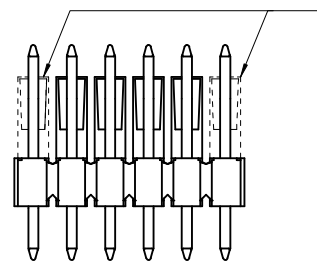

REMOVE LAST CKT ID EC NO: UCP2017-1789 DRWNS:APPELDORN 2017/02/16 CHKD:KKIPPER 2017/02/16 APPR:FSMLTH 2017/02/27	QUALITY SYMBOLS ▽=0 ▽=0 ▽=0	GENERAL TOLERANCES (UNLESS SPECIFIED)		DIMENSION STYLE IN/MM	SCALE .100/(2.54)	DESIGN UNITS INCH	THIRD ANGLE PROJECTION	
		4 PLACES ± --- ± ---	3 PLACES ± --- ± .010	DRAWN BY GUZIK	DATE 1988/08/24	100/(2.54) KK HOUSING FOR SHROUDED CRIMP TERMINAL		
		2 PLACES ± 0.25 ± .014	1 PLACE ± 0.35 ± ---	CHECKED BY PATEL	DATE 1988/08/24	MOLEX INCORPORATED		
		ANGULAR ± 1/2°		APPROVED BY	DATE	MATERIAL NO. SEE CHART	DOCUMENT NO. SD-7880	SHEET NO. 2 OF 2
DRAFT WHERE APPLICABLE MUST REMAIN WITHIN DIMENSIONS		THIS DRAWING CONTAINS INFORMATION THAT IS PROPRIETARY TO MOLEX INCORPORATED AND SHOULD NOT BE USED WITHOUT WRITTEN PERMISSION						