

勝特力材料 886-3-5753170  
勝特力电子(上海) 86-21-34970699  
勝特力电子(深圳) 86-755-83298787  
[Http://www.100y.com.tw](http://www.100y.com.tw)



Extract from the online  
catalog

## MC 1,5/ 9-G-3,81

Order No.: 1803345

The figure shows a 10-position version of the product



<http://eshop.phoenixcontact.de/phoenix/treeViewClick.do?UID=1803345>

Header, Nominal current: 8 A, Nom. voltage: 160 V, Pitch: 3.81 mm,  
Number of positions: 9, Color: green, Assembly: Soldering

### Commercial data

EAN	4017918045654
Pack	50 pcs.
Customs tariff	85366990
Weight/Piece	0.002564 KG
Catalog page information	Page 174 (CC-2009)

### Product notes

WEEE/RoHS-compliant since:  
01/01/2003



<http://www.download.phoenixcontact.com>  
Please note that the data given here has been taken from the online catalog. For comprehensive information and data, please refer to the user documentation. The General Terms and Conditions of Use apply to Internet downloads.

### Technical data

#### Dimensions / positions

Length	9.2 mm
Pitch	3.81 mm
Dimension a	30.48 mm
Number of positions	9
Pin dimensions	0,8 x 0,8 mm

Hole diameter	1.2 mm
<b>Technical data</b>	
Insulating material group	IIIa
Rated surge voltage (III/3)	2.5 kV
Rated surge voltage (III/2)	2.5 kV
Rated surge voltage (II/2)	2.5 kV
Rated voltage (III/2)	160 V
Rated voltage (II/2)	250 V
Connection in acc. with standard	EN-VDE
Nominal current $I_N$	8 A
Nominal voltage $U_N$	160 V
Maximum load current	8 A
Insulating material	PBT
Inflammability class acc. to UL 94	V0

#### Certificates / Approvals



Certification

CB, CSA, CUL, GOST, UL, VDE-PZI

#### CSA

Nominal voltage $U_N$	300 V
Nominal current $I_N$	8 A

#### CUL

Nominal voltage $U_N$	300 V
Nominal current $I_N$	8 A

#### UL

Nominal voltage $U_N$	300 V
Nominal current $I_N$	8 A

勝特力材料 886-3-5753170  
 勝特力电子(上海) 86-21-34970699  
 勝特力电子(深圳) 86-755-83298787  
[Http://www.100y.com.tw](http://www.100y.com.tw)

### Accessories

Item	Designation	Description
<b>General</b>		
1841174	MC 1,5/10-LWL 1,5-3,81	Fiber optics, Pitch: 3.81 mm, Number of positions: 10, Dimension a: 1.5 mm, Color: transparent
1841190	MC 1,5/10-LWL 2,3-3,81	Fiber optics, Pitch: 3.81 mm, Number of positions: 10, Dimension a: 2.3 mm, Color: transparent
1841213	MC 1,5/10-LWL 4-3,81	Fiber optics, Pitch: 3.81 mm, Number of positions: 10, Dimension a: 4 mm, Color: transparent
<b>Marking</b>		
1051993	B-STIFT	Marker pen, for manual labeling of unprinted Zack strips, smear-proof and waterproof, line thickness 0.5 mm
0804109	SK 3,81/2,8:FORTL.ZAHLEN	Marker card, printed horizontally, self-adhesive, 10-section marker strip, 14 identical decades marked 1-10, 11-20 etc. up to 91-(99)100, sufficient for 140 terminal blocks
0805056	SK 3,81/2,8:SO	Marker card, special printing, self-adhesive, labeled acc. to customer requirements, 14 identical marker strips per card, max. 25-position labeling per strip, color: White
<b>Plug/Adapter</b>		
1734634	CP-MSTB	Keying profile, is inserted into the slot on the plug or inverted header, red insulating material

### Additional products

Item	Designation	Description
<b>General</b>		
1851119	FK-MCP 1,5/ 9-ST-3,81	Plug component, Nominal current: 8 A, Nom. voltage: 160 V, Pitch: 3.81 mm, Number of positions: 9, Connection type: Spring-cage conn., Color: green
1850738	FRONT-MC 1,5/ 9-ST-3,81	Plug component, Nominal current: 8 A, Nom. voltage: 160 V, Pitch: 3.81 mm, Number of positions: 9, Connection type: Screw connection, Color: green
1862645	IMC 1,5/ 9-G-3,81	Header, Nominal current: 8 A, Nom. voltage: 160 V, Pitch: 3.81 mm, Number of positions: 9, Color: green, Assembly: Soldering
1875496	IMCV 1,5/ 9-G-3,81	Header, Nominal current: 8 A, Nom. voltage: 160 V, Pitch: 3.81 mm, Number of positions: 9, Color: green, Assembly: Soldering
1803646	MC 1,5/ 9-ST-3,81	Plug component, Nominal current: 8 A, Nom. voltage: 160 V, Pitch: 3.81 mm, Number of positions: 9, Connection type: Screw connection, Color: green

1852244	MCC 1/ 9-STZ-3,81	Plug component, Nominal current: 8 A, Nom. voltage: 160 V, Pitch: 3.81 mm, Number of positions: 9, Connection type: Crimp connection, Color: green
1827198	MCVR 1,5/ 9-ST-3,81	Plug component, Nominal current: 8 A, Nom. voltage: 160 V, Pitch: 3.81 mm, Number of positions: 9, Connection type: Screw connection, Color: green
1827046	MCVW 1,5/ 9-ST-3,81	Plug component, Nominal current: 8 A, Nom. voltage: 160 V, Pitch: 3.81 mm, Number of positions: 9, Connection type: Screw connection, Color: green
1897461	QC 0,5/ 9-ST-3,81	Plug component, Nominal current: 6 A, Nom. voltage: 320 V, Pitch: 3.81 mm, Number of positions: 9, Connection type: Insulation displacement connection QUICKON, Color: green

### Diagrams/Drawings

Drilling plan/solder pad geometry

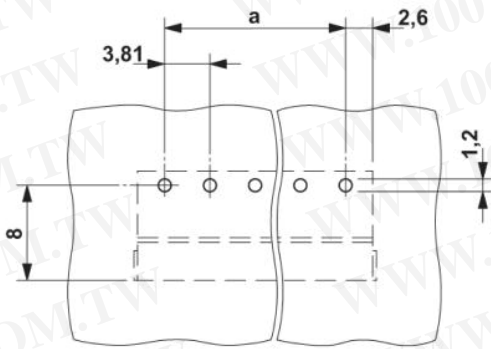

勝特力材料 886-3-5753170  
 勝特力电子(上海) 86-21-34970699  
 勝特力电子(深圳) 86-755-83298787  
[Http://www.100y.com.tw](http://www.100y.com.tw)

Dimensioned drawing

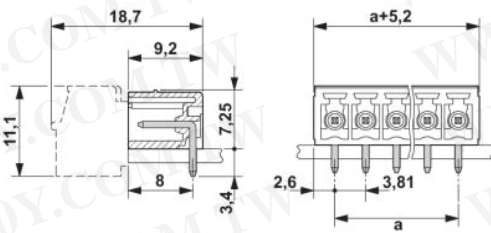



**Address**

PHOENIX CONTACT Inc., USA  
586 Fulling Mill Road  
Middletown, PA 17057, USA  
Phone (800) 888-7388  
Fax (717) 944-1625  
<http://www.phoenixcon.com>



勝特力材料 886-3-5753170  
勝特力电子(上海) 86-21-34970699  
勝特力电子(深圳) 86-755-83298787  
[Http://www.100y.com.tw](http://www.100y.com.tw)

© 2010 Phoenix Contact  
Technical modifications reserved;