

THIS DRAWING IS UNPUBLISHED.

RELEASED FOR PUBLICATION

ALL RIGHTS RESERVED.

© COPYRIGHT - By -

REVISIONS

変更

P	LTR	DESCRIPTION	DATE	DWN	APVD
E8		REVISED PER ECR-23-175142	21AUG2023	SS	EW

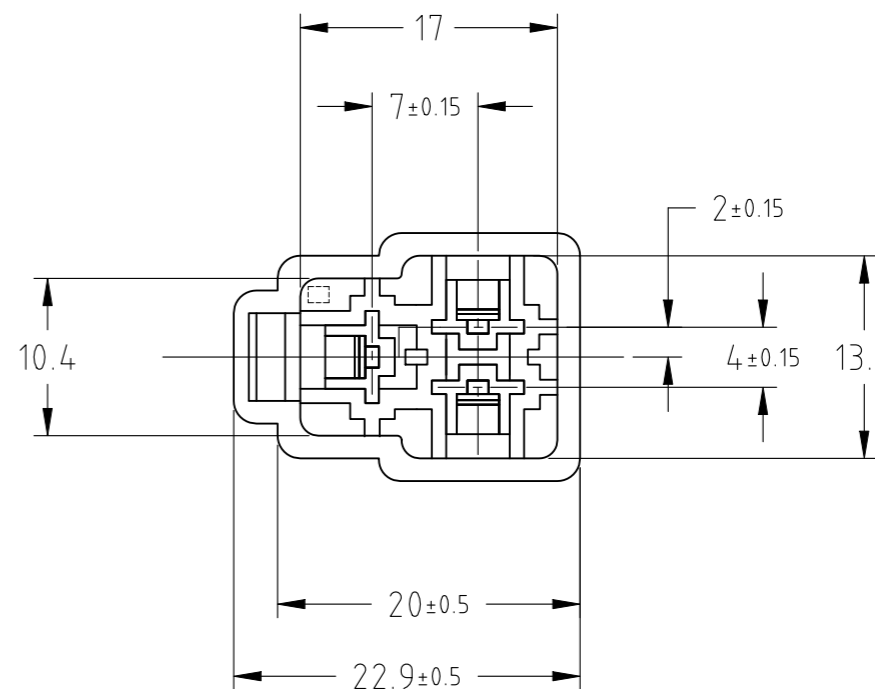
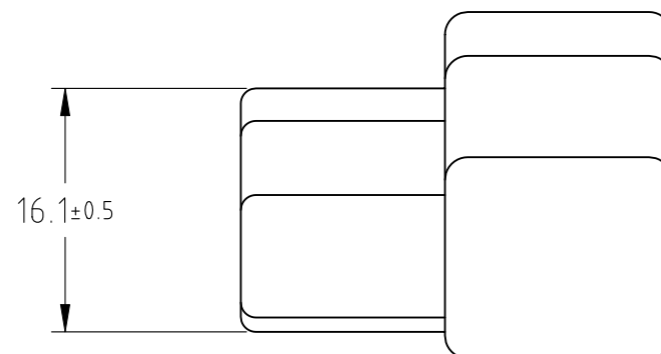
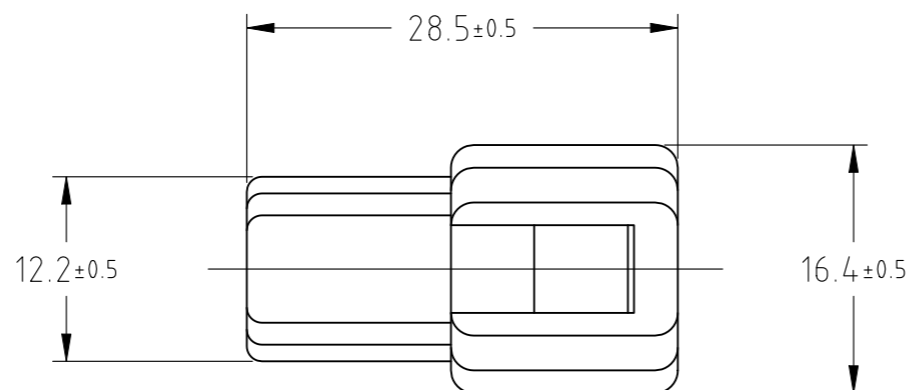
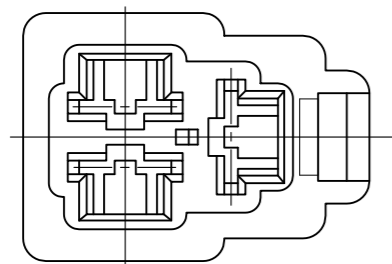

注記

- 1. かん合する相手ハウジングは型番172132
- 2. 使用端子は型番170340,170341,170349
- ③材料：6/6ナイロン（UL94V-2）
- ④材料：6/6ナイロン（UL94V-0）

NOTES

- 1. THE MATING PLUG HOUSING P/N : 172132
- 2. APPLIED CONTACT P/N : 170340,170341,170349
- ③ MATERIAL : 6/6NYLON (UL94V-2)
- ④ MATERIAL : 6/6NYLON (UL94V-0)
- ⑤ OBSOLETE PARTS: OBSOLETE CIS STREAMLINING PER D.RENAUD/D.SINISI

勝特力電材超市-龍山店 886-3-5773766
 勝特力電材超市-光復店 886-3-5729570
 勝特力电子(上海) 86-21-34970699
 勝特力电子(深圳) 86-755-83298787
<http://www.100y.com.tw>

④	BLUE	2-172131-5
④	NATURAL	2-172131-1
④	NATURAL	1-172131-1
③	GRAY	172131-6
③	BLACK	172131-2
材料	色調	型番
MATERIAL	COLOR	PART NUMBER

THIS DRAWING IS A CONTROLLED DOCUMENT.		DWN J.SATO 14OCT2008	STE TE Connectivity											
DIMENSIONS: 単位: 耗 mm		CHK S.MANABE 14OCT2008												
TOLERANCES UNLESS OTHERWISE SPECIFIED: 一般公差		APVD S.MANABE 14OCT2008	250 SERIES HOUSING LANCE CONNECTOR 3POS CAP HOUSING											
<table border="0"> <tr><td>0 PLC</td><td>± 0.2</td></tr> <tr><td>1 PLC</td><td>± 0.25</td></tr> <tr><td>2 PLC</td><td>± 0.3</td></tr> <tr><td>3 PLC</td><td>±</td></tr> <tr><td>4 PLC</td><td>±</td></tr> <tr><td>ANGLES</td><td>± 3°</td></tr> </table>		0 PLC				± 0.2	1 PLC	± 0.25	2 PLC	± 0.3	3 PLC	±	4 PLC	±
0 PLC	± 0.2													
1 PLC	± 0.25													
2 PLC	± 0.3													
3 PLC	±													
4 PLC	±													
ANGLES	± 3°													
MATERIAL 材料 SEE NOTE		FINISH 仕上	APPLICATION SPEC 取付適用規格	SIZE A3	CAGE CODE 00779	DRAWING NO 番号 C-172131	RESTRICTED TO —							
CUSTOMER DRAWING			WEIGHT	SCALE 尺度 2:1	SHEET 1 OF 1	REV E8								



NOTE

All numerical values are in metric units [with U.S. customary units in brackets]. Dimensions are in millimeters [and inches]. Unless otherwise specified, dimensions have a tolerance of ± 0.13 [$\pm .005$] and angles have a tolerance of $\pm 2^\circ$. Figures and illustrations are for identification only and are not drawn to scale.

1. INTRODUCTION

This specification covers the requirements for application of .110, .187, .250, .312, and .375 Series FASTIN-FASTON housings and contacts for wire-to-wire applications. The housings are available with 1, 2, 3, 4, 6, 8, 10, and 11 circuit positions. Each housing features circuit identification markings on the mating face of the housing and polarization features for positive mating. The .187 and .250 Series receptacle housings are available with mounting flanges for panel mounting.

Each contact features a wire barrel, insulation barrel, locking lance, detent, and mating tab or rolls. The wire barrel has serrations that help retain the wire to the contact after crimping. The receptacle contact accepts tab widths of 2.79 [.110], 4.75 [.187], 6.35 [.250], 7.92 [.312], and 9.52 [.375]. When contacts are mated, the detents engage to provide retention force. The contacts are available in loose piece for terminating using a hand tool and reel-mounted for terminating using automatic machines.

When corresponding with personnel, use the terminology provided in this specification to facilitate your inquiries for information. Basic terms and features of this product are provided in Figure 1.

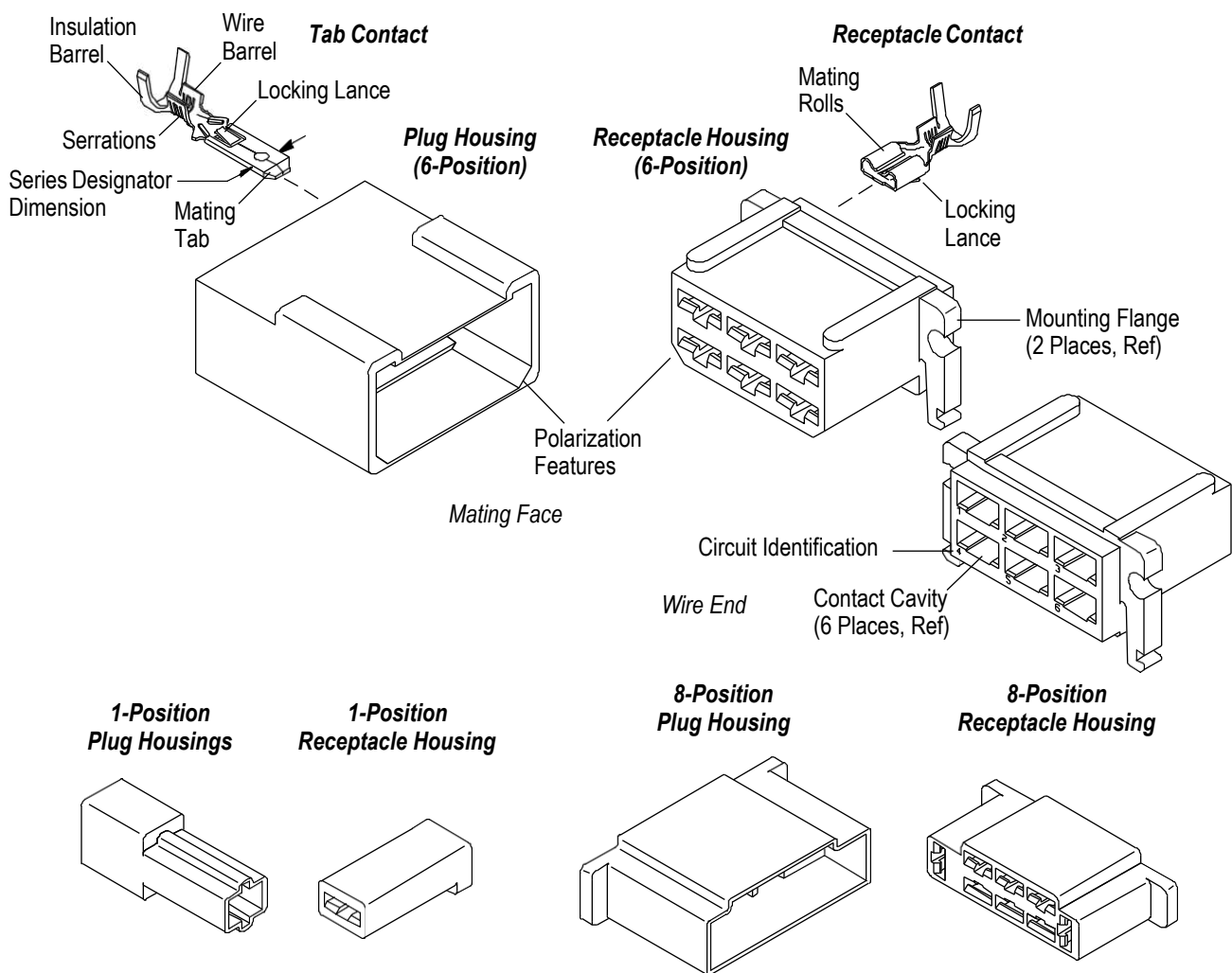

Figure 1

2. REFERENCE MATERIAL

2.1. Revision Summary

Revisions to this application specification include:

- Added text to Paragraph 3.4,B and illustration to Figure 2

2.2. Customer Assistance

To ensure consistent and high-quality terminations, TE Connectivity (TE) product engineering has analyzed and tested the design factors of numerous terminal crimp connections with varying wire ranges defined by the terminals. As a result, TE product engineering has defined five criteria necessary to achieve a reliable crimp: be sure to 1) use the TE product only for an application it was designed for, 2) always use the TE recommended application tooling, 3) use an appropriately selected and prepared wire, 4) adhere to the application specification described in the associated TE product print and application documentation (such as the TE 114-Application Specification, and TE Applicator “Log Sheet” print), and 5) have the product handled by trained operators only. TE product performance according to TE product specification can be achieved using the methods described in this application specification with the use of the recommended, properly maintained tooling and applicator.

If tooling or termination equipment is used other than what is recommended by TE, where such tooling or equipment was not used for agency validation and/or the product qualification process, TE does not make any representation or warranty, expressed or implied, and disclaims liability for non-performance per TE product specification. Customer accepts the sole responsibility for the evaluation, application, and use of the terminals in such circumstances.

Reference Product Base Part Number 480003 and Product Code 1108 are representative of .110, .187, .250, .312, and .375 Series FASTIN-FASTON housings and contacts. Use of these numbers will identify the product line and help you to obtain product and tooling information. Such information can be obtained through a local Representative, by visiting our website at www.te.com, or by calling PRODUCT INFORMATION or the TOOLING ASSISTANCE CENTER at the numbers at the bottom of page 1.

2.3. Drawings

Customer Drawings for product part numbers are available from the service network. If there is a conflict between the information contained in the Customer Drawings and this specification or with any other technical documentation supplied, the information contained in the Customer Drawings takes priority.

2.4. Specifications

Product Specification 108-2002 provides product performance and test results for .187 Series FASTIN-FASTON connectors.

2.5. Instructional Material

Instruction Sheets (408-series) provide product assembly instructions or tooling setup and operation procedures and Customer Manuals (409-series) provide machine setup and operating procedures. Documents available that pertain to this product are:

- 408-3295 Preparing Reel of Contacts for Application Tooling
- 408-4138 Double Action Hand Tool 189508-1
- 408-7424 Checking Terminal Crimp Height or Gaging Die Closure
- 408-7432 Force Gage 92-100505 for Testing Terminals
- 408-8039 Heavy Duty Quick Change Applicators (End Feed Type)
- 408-8053 Conversion guide for Miniature Quick-Change Applicators
- 408-9580 Extraction Tip 465665-1 for Use with Universal Handle Assembly 465629-1
- 408-9816 Handling of Reeled Products
- 409-5866 AMPOMATOR* CLS IV Lead-Making Machine
- 409-5870 Crimp Quality Monitors for AMPOMATOR CLS IV Lead-Making Machines
- 409-5842 AMP-O-LECTRIC* Model “G” Terminating Machines 354500-[]

3. REQUIREMENTS

3.1. Temperature

The temperature rating of these housings is up to 125°C [256°F] to permit use in applications of relatively high temperatures.

3.2. Storage

A. Ultraviolet Light

Prolonged exposure to ultraviolet light may deteriorate the chemical composition used in the housing material.

B. Reel Storage

When using reeled contacts, store coil wound reels horizontally and traverse wound reels vertically.

C. Shelf Life

The contacts should remain in the shipping containers until ready for use to prevent deformation to the contact. The contacts should be used on a first in, first out basis to avoid storage contamination that could adversely affect signal transmissions.

Over time discoloration phenomenon could be occurred on housing produced with natural Nylon, reflected in green, yellow or a dark white. However, it doesn't affect the Form, Fit and Function of the product as guaranteed by resin supplier and endorsed by our validation. For more details please visit te.com for the White Paper Nylon Discoloration.

D. Chemical Exposure

Do not store contacts near any chemicals listed below as they may cause stress corrosion cracking in the contacts.

Alkalies	Ammonia	Citrates	Phosphates	Citrates	Sulfur Compounds
Amines	Carbonates	Nitrites	Sulfur Nitrites		Tartrates



NOTE

Where the above environmental conditions exist, phosphor-bronze contacts are recommended instead of brass.

3.3. Wire Selection and Preparation

The contacts accept stranded wire size range of 26 through 8 AWG. The acceptable insulation diameter of each contact is given in the applicator sheet.

Proper strip length is necessary to properly insert the wire into the contact. An illustration of this is shown in Figure 2. The strip length of the wire is given in the applicator sheet. A list of applicators is given in Figure 8.



CAUTION

The wire conductor must not be nicked, scraped, or cut during the stripping operation.

3.4. Crimp Requirements



CAUTION

Wire insulation shall NOT be cut or broken during the crimping operation. Reasonable care should be taken by tooling operators to provide undamaged wire terminations.

A. Wire Barrel Crimp

The crimp applied to the wire barrel of the contact is the most compressed area and is most critical in ensuring optimum electrical and mechanical performance of the contact. The crimp height and width must be within the dimensions provided in the applicator sheet.

B. Insulation Barrel Crimp

The crimp applied to the insulation barrel of the contact must result in either an "F" crimp where the insulation barrel forms a closed seam with no evidence of wire insulation in the seam or an overlap crimp where the tips of the insulation barrel wraps overlap each other and wrap firmly around the wire insulation without cutting into the wire insulation. Alternatively, for wires having a reduced insulation thickness, a scroll

crimp is acceptable where each tip of the insulation barrel wraps inward to form a curl that touches the wire insulation. The wire must be centered within the crimped insulation barrel. Refer to Figure 2.

C. Crimp Length

Effective crimp length is defined as that portion of the wire barrel, excluding the bellmouths, fully formed by the crimping tool. Refer to Figure 2 and the applicator sheet.

D. Bellmouths

Front and rear bellmouths shall be evident and conform to the dimensions given in Figure 2. Both front and rear bellmouths dimension is required to be 0.5mm to 0.76mm for special terminal 160928-* crimping.

E. Cutoff Tab and Burr

The cutoff tab shall be cut to and the cutoff burr shall not exceed the dimensions given in Figure 2.

F. Wire Barrel Flash

The wire barrel flash shall not exceed the dimension given in Figure 2.

G. Wire Location

The wire conductors and insulation must be visible in the transition area (the area between the wire barrel and insulation barrel). The conductors may extend beyond the wire barrel to the maximum dimension given in Figure 2.

H. Wire Barrel Seam

The wire barrel seam must be closed with no evidence of loose wire strands visible in the seam.

Note: Not to Scale

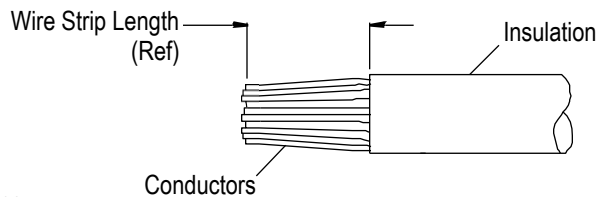

Note: Receptacle contact shown, same requirements apply to tab contact.

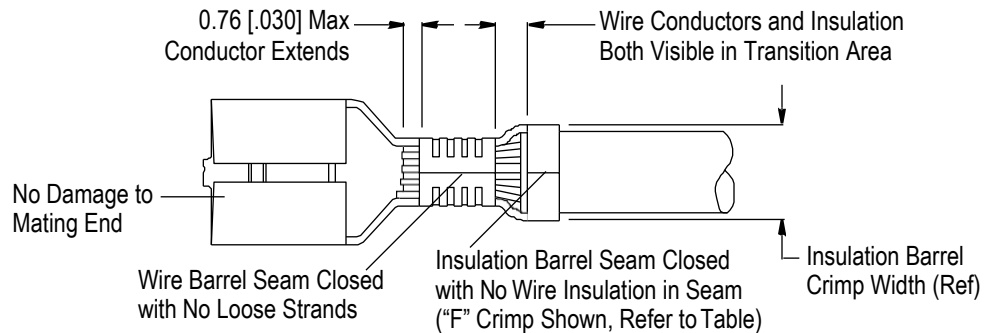

Section X-X

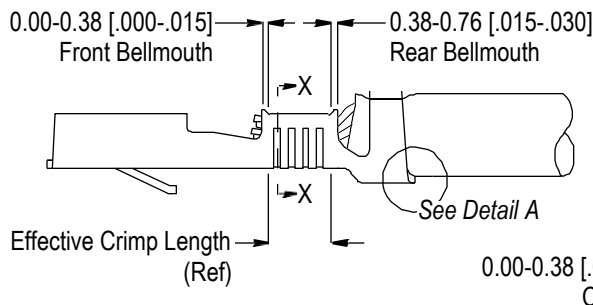
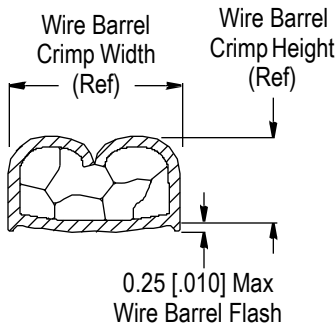

Detail A

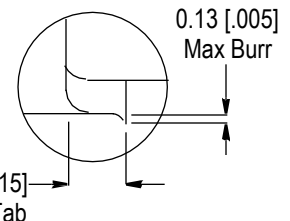

INSULATION BARREL CRIMP			
TYPE	QUALITY		
	CORRECT	TOO LOOSE	TOO TIGHT
"F"			
Overlap			
Scroll			

Figure 2

I. Twist and Roll

There shall be no deformation or other damage to the crimped wire barrel or mating portion of the crimped contact that will prevent proper mating. Twist and roll is permissible to the limit given in Figure 3.

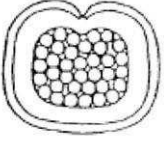
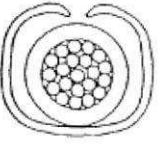
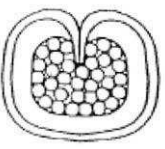
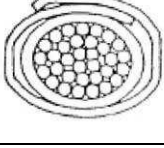
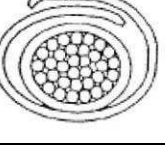
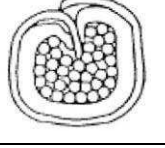
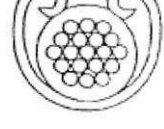
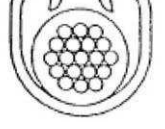
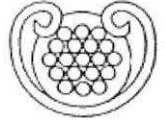
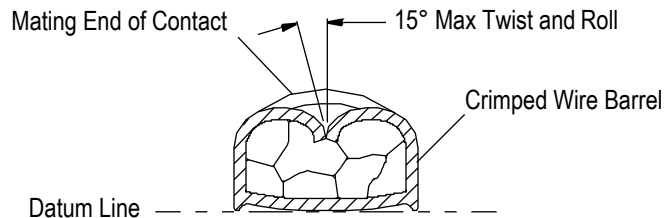

Figure 3

J. Straightness

The force applied during crimping may cause some bending between the crimped wire barrel and the mating portion of the contact. Such deformation is acceptable within the following limits.

Up and down — the crimped contact, including cutoff tab and burr, shall not be bent beyond the limitations given in Figure 4.

Side-to-side — side-to-side bending of the contact may not exceed the limits provided in Figure 4.



NOTE

Periodic inspections must be made to ensure crimped contact formation is consistent.

Up and Down Alignment

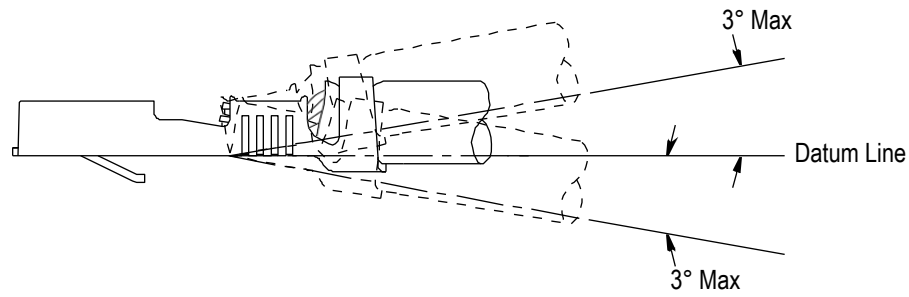

Side-to-Side Alignment

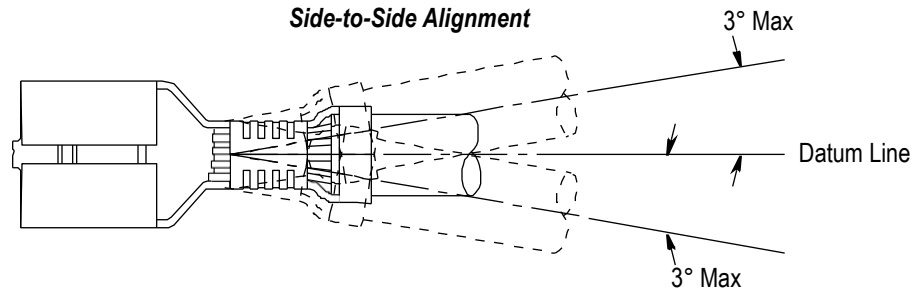

Figure 4

3.5. Tensile Inspection

Crimped contacts should hold the wire firmly and have a pull-test tensile value meeting the values given in Figure 5.



NOTE

The head travel of the tensile testing machine must be adjusted to 25.4 [1.0] per minute. Force must be directly and gradually applied for 1 minute.

WIRE SIZE (AWG)	MINIMUM FORCE (N [lbs])
26	17.80 [4]
24	26.70 [6]
22	35.60 [8]
20	57.80 [13]
18	89.00 [20]
16	133.40 [30]
14	222.40 [50]
12	311.40 [70]
10	355.90 [80]
8	400.30 [90]

Figure 5

3.6. Contact Insertion

Each contact must be inserted into the appropriate contact cavity from the wire end of the housing. There will be an audible or tactile “click” when the contact is fully seated in the housing. The wire must be pulled back gently to ensure that the contact locking lance has locked onto the housing locking finger. See Figure 6.

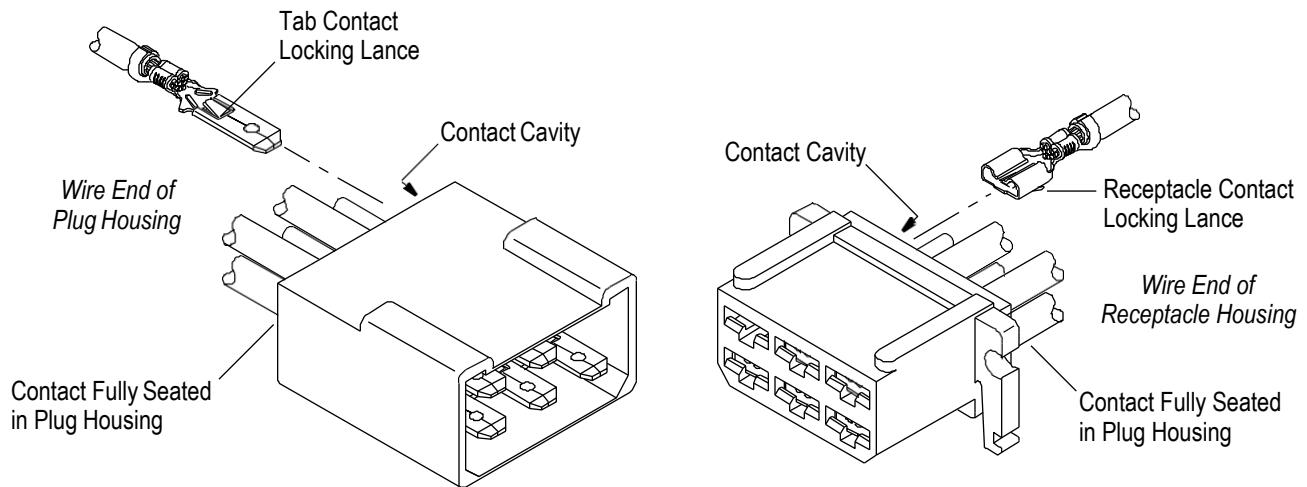

Figure 6

3.7. Panel

The .187 and .250 Series receptacle housings that can be mounted to a panel, hardware, and related panel cutout dimensions are given in Figure 7.

3.8. Mating

The polarization features of the plug housing and receptacle housing must be aligned before pushing the housings together.

3.9. Repair

Damaged or defective contacts or housings must not be used. If a damaged contact is apparent before it is inserted into the housing, the wire must be cut at the back of the contact and the wire end must be re-terminated. If contacts or housings are damaged after contact insertion, the wire must be cut directly at the wire end of the housing and new contacts or housings must be used.

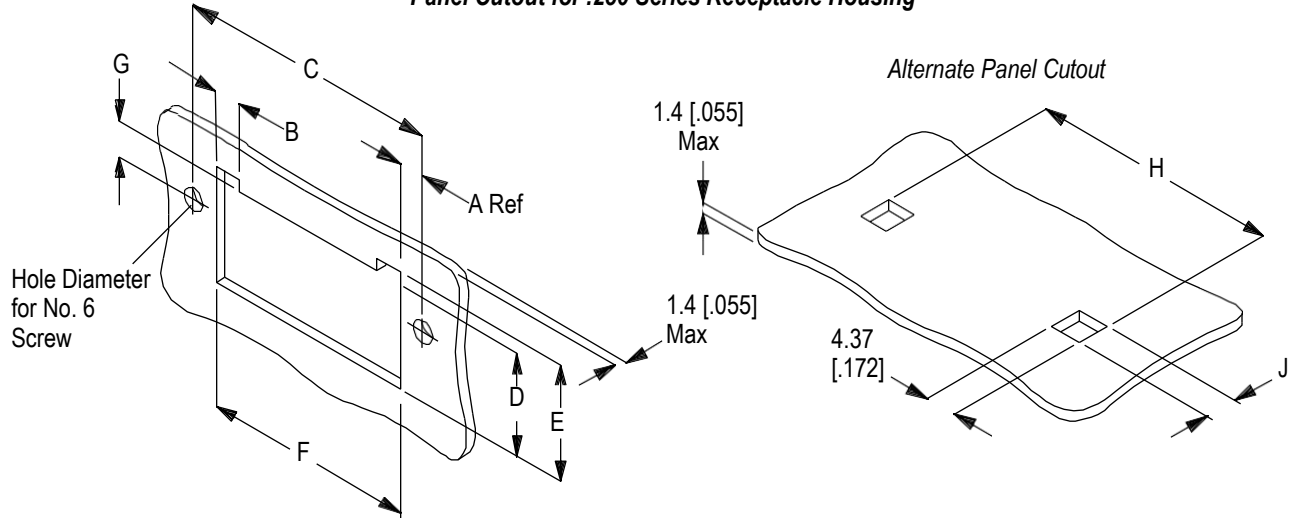
Panel Cutout for .250 Series Receptacle Housing

.250 SERIES RECEPTACLE HOUSING SIZE	PANEL DIMENSION								
	A	B	C	D	E	F	G	H	J
4	2.31 [.091]	—	29.77 [1.172]	15.88 [.625]	—	25.15 [.990]	6.73 [.265]	28.58 [1.125]	6.35 [.250]
6	3.43 [.135]	3.56 [.140]	35.86 [1.412]	14.22 [.560]	15.88 [.625]	29.01 [1.142]	4.7 [.185]	34.42 [1.355]	3.96 [.156]
8	4.39 [.173]	6.1 [.240]	47.52 [1.871]	16.76 [.660]	18.42 [.725]	38.74 [1.525]	6.6 [.260]	46.23 [1.820]	6.35 [.250]

Panel Cutout for .187 Series Receptacle Housing

.187 SERIES RECEPTACLE HOUSING		PANEL DIMENSION	
MODULES	CIRCUITS	K	L
1	3	8.51 [.335]	—
2	6	16.64 [.655]	8.13 [.320]
3	9	24.76 [.975]	16.26 [.640]
4	12	32.89 [1.295]	24.38 [.960]
5	15	41.02 [1.615]	32.51 [1.280]

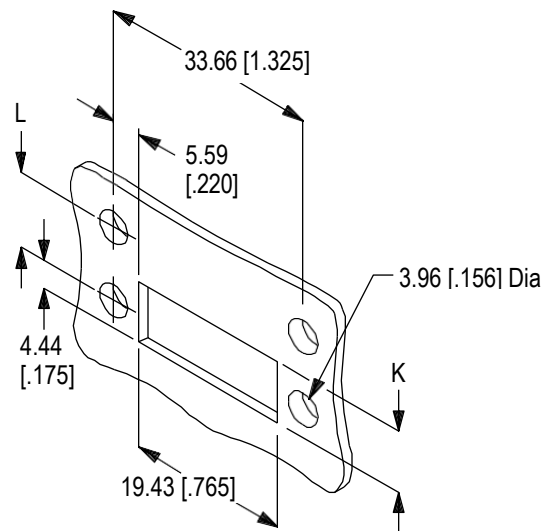

Figure 7

4. QUALIFICATION

FASTIN-FASTON connectors are Recognized under the Component Program of Underwriters Laboratories, Inc. (UL) in File E 28476 and Certified by CSA International in File LR7189.

5. TOOLING

Tooling part numbers and instructional material packaged with the tooling are shown in Figure 8.

5.1. Hand Tool

The hand tool is designed to crimp a loose-piece contact onto the wire. The available hand tool for these contacts terminates a specific wire size range and insulation diameter range.

5.2. Applicator and Power Unit

The applicator terminates tape-mounted contacts onto wire. The applicator must be installed onto a machine. The machine provides the force required to drive the applicator. The machine can be set up to automatically measure, cut, strip, and terminate wire. These machines are designed to be floor standing.

5.3. Contact Extraction

The universal handle assembly with proper extraction tip is designed to release the locking lance of the contact from the housing without damaging the housing or contact.

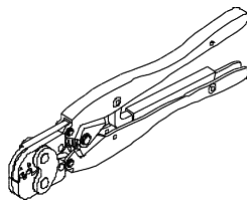

Double Action Hand Tool 189508-1 for Wire Size 18-14 AWG with Insulation Diameter of 2.2-3.1 [.090-.120] (408-4138)

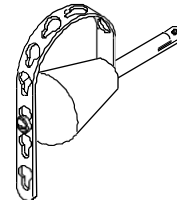

Universal Handle Assembly 465629-1 (408-7141) with Extraction Tip 465665-1

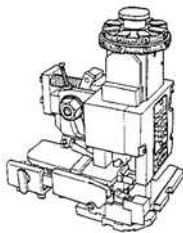

Heavy Duty Quick Change Applicators (End Feed Type) (408-8039)

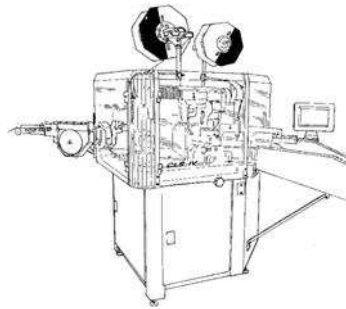

AMPOMATOR CLS IV Lead-Making Machine 217500-1 or -2 (409-5866)

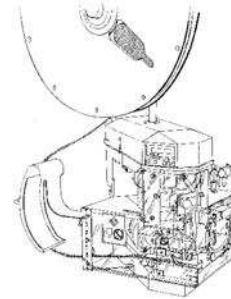

AMP-O-ELECTRIC Model "G" Terminating Machine 354500-1 (409-5842)

Figure 8 (Cont'd)

WIRE		TOOLING	
SIZE (AWG)	INSULATION DIAMETER	APPLICATOR	POWER UNIT
(2) 28	1.52-3.18 [.060-.125]	567487-2	Model "G"
26-24	1.52-3.18 [.060-.125]	567487-2	
22-18	1.52-2.54 [.060-.100]	687979-3, 687982-1	Model "G"
		687979-1	CLS IV
	2.16-3.18 [.085-.125]	687981-1, 687982-1	Model "G"
		687981-1	CLS IV
2.03-3.05 [.080-.120]	567135-1, 687982-1	Model "G"	
	567135-2	CLS IV	
22-16	2.29-3.3 [.090-.130]	466683-1	Model "G"
		466683-2	CLS IV
20-16	2.03-3.05 [.080-.120]	466737-1	Model "G"
		466737-3	CLS IV
	—	567326-1	Model "G"
		567326-2	CLS IV
18-14	3.05-4.06 [.120-.160]	687839-1	Model "G"
			CLS IV
	687932-1	Model "G"	
		CLS IV	
18-14 or (2) 18	3.05-4.32 [.120-.170]	687940-1	CLS IV
			Model "G"
16-12	4.06-5.59 [.160-.220] or (2 Wires) 3.3 [.130] Max	466057-4	Model "G"
		466057-1	CLS IV
16-12 or (2) 16	4.06-5.33 [.160-.210] or (2 Wires) 3.3 [.130] Max	466058-1	CLS IV
		466058-2	Model "G"
16-12, (2) 16, 14, or 16 and 18	4.06 [.160] Max	687944-1	CLS IV
			Model "G"
14-10	3.05-4.32 [.120-.170]	466092-1	CLS IV
		466092-4	Model "G"
12-10	3.43-5.08 [.135-.200]	466331-1	Model "G"
			CLS IV
	3.81-5.08 [.150-.200]	466848-2	Model "G"
10	5.08-6.98 [.200-.275]	466875-2	Model "G"
8	5.08-6.98 [.200-.275]	466875-2	Model "G"

Figure 8 (End)

6. VISUAL AID

The illustration below shows a typical application of .110, .187, .250, .312, and .375 Series FASTIN-FASTON housings and contacts. This illustration should be used by production personnel to ensure a correctly applied product. Applications which DO NOT appear correct should be inspected using the information in the preceding pages of this specification and in the instructional material shipped with the product or tooling.

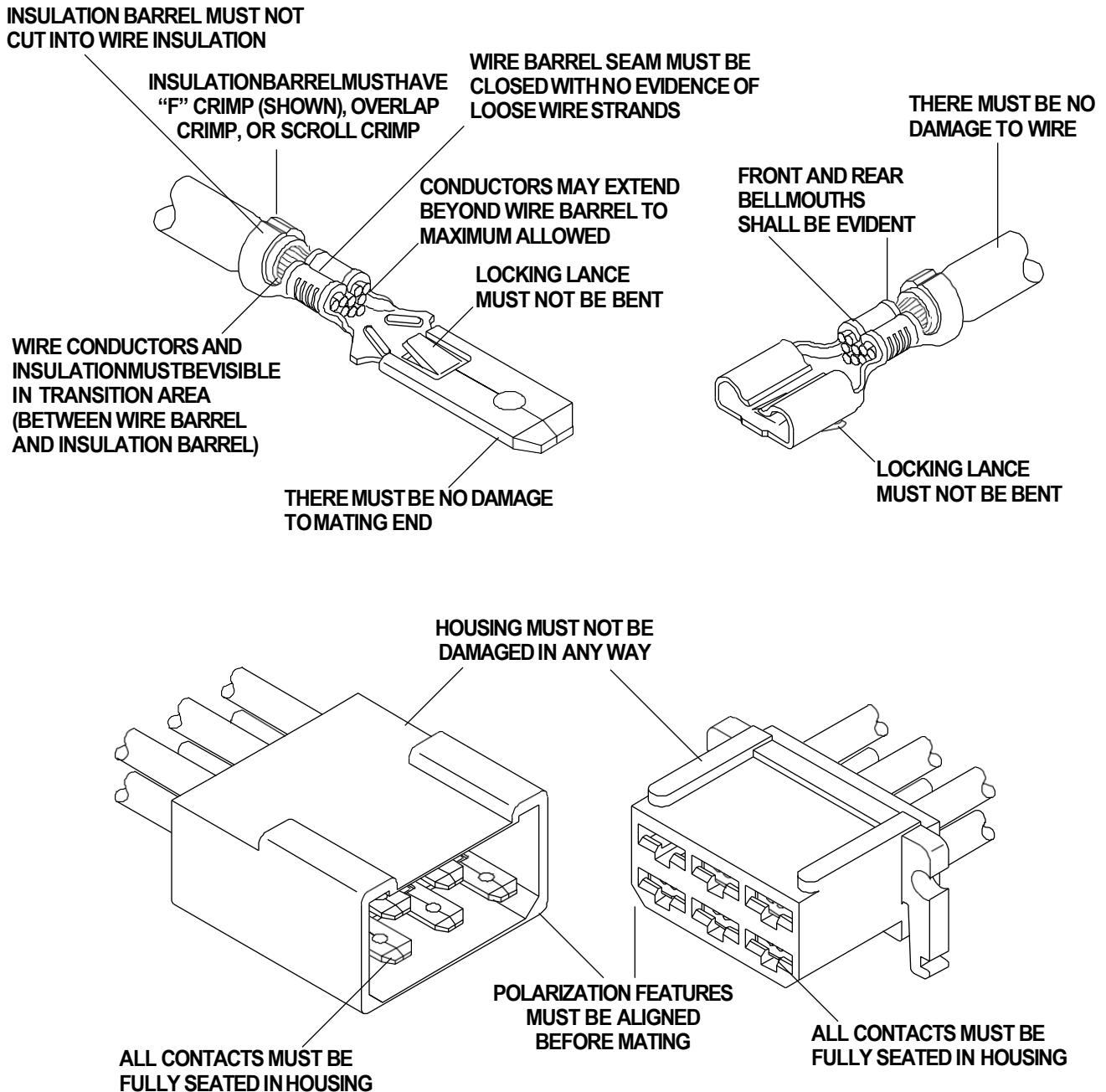

FIGURE 9. VISUAL AID