

THIS DRAWING IS UNPUBLISHED. RELEASED FOR PUBLICATION  
 © COPYRIGHT 2019 By Tyco Electronics Japan G.K. ALL RIGHTS RESERVED.

P	LTR	DESCRIPTION	DATE	DWN	APVD
	E5	REVISED ECR-19-009995	04OCT2019	DM	HK

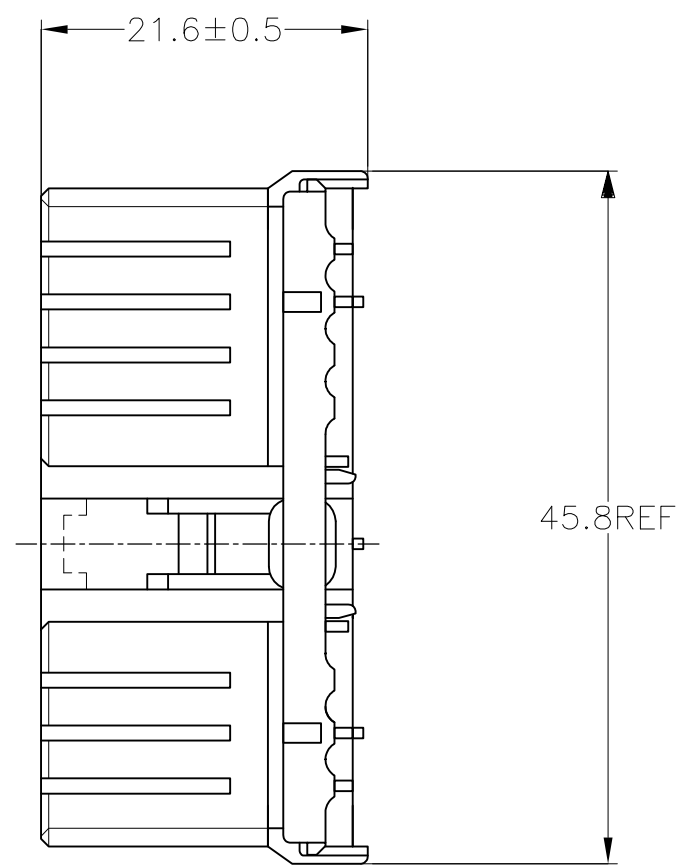
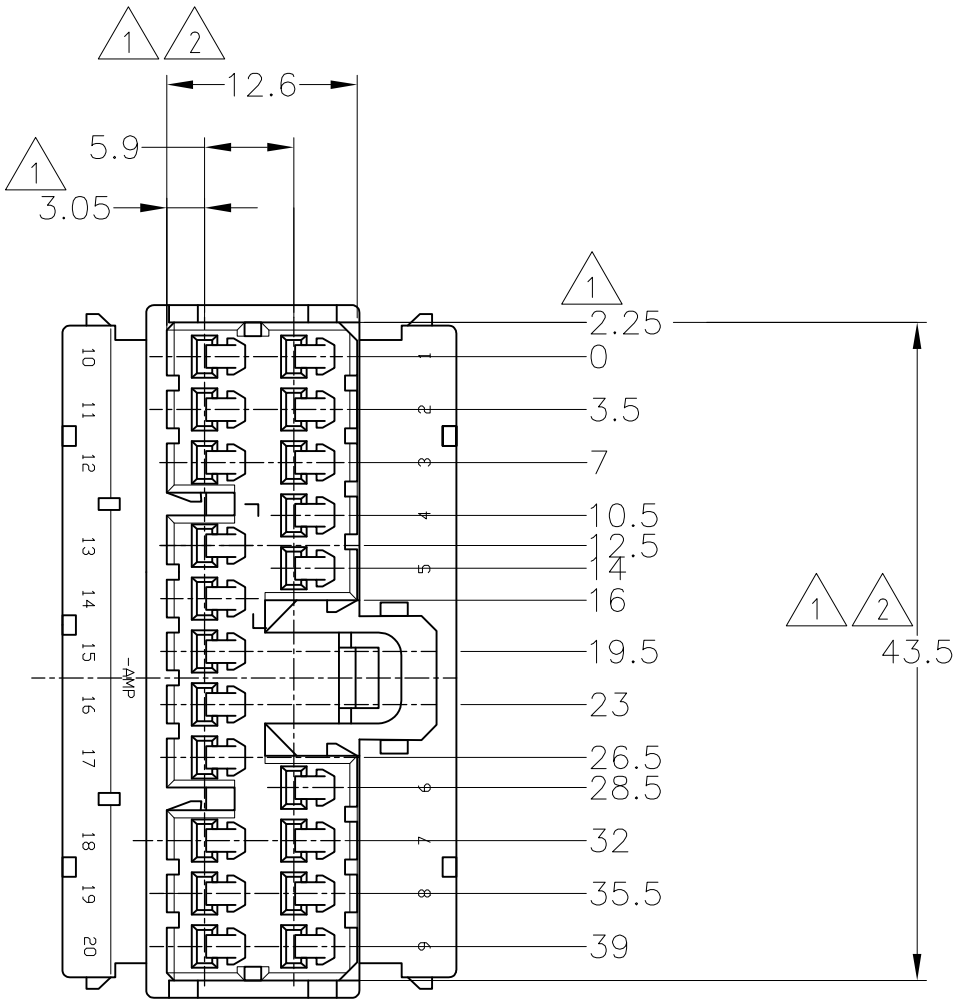

勝特力電材超市-龍山店 886-3-5773766  
 勝特力電材超市-光復店 886-3-5729570  
 勝特力電子(上海) 86-21-34970699  
 勝特力電子(深圳) 86-755-83298787  
<http://www.100y.com.tw>

- MUST BE KEPT BETWEEN **-A-** AND 2
  - TO BE MATED WITH PLUG HOUSING SMOOTHLY
  - APPLIED TAB CONTACT; P/N 173630 AND 173631
  - APPLIED CAP HOUSING; P/N 174936 etc
- A-** 面より2mmの範囲で測定
  - 相手ハウジングと所定の機能を満足して嵌合できること
  - 内装するタブコンタクトは型番173630、173631
  - 嵌合相手ハウジング型番174936 他

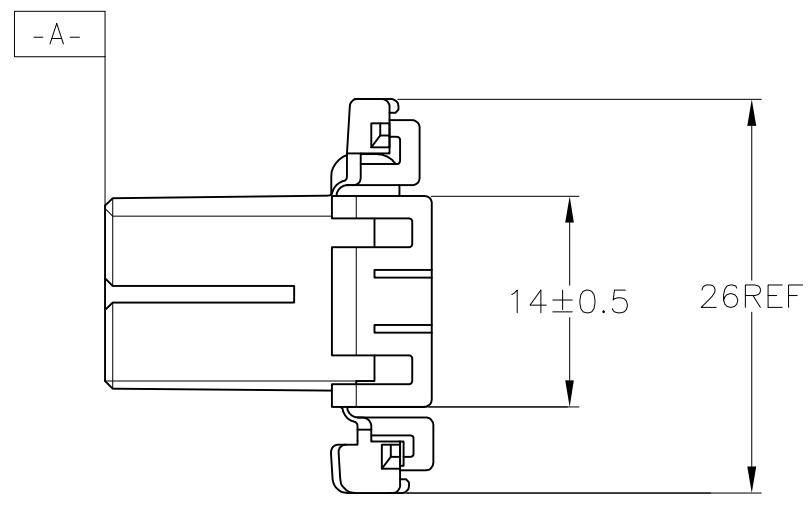

V-2	自然色 (NATURAL)	1-174952-1
HB	黄 (YELLOW)	174952-7
	灰 (GRAY)	174952-6
	青 (BLUE)	174952-5
	緑 (GREEN)	174952-4
	黒 (BLACK)	174952-2
	自然色 (NATURAL)	174952-1
使用材料難燃グレード (FLAMMABILITY OF MATERIAL)		色 (COLOR) 型番 (PART NUMBER)

TOLERANCES UNLESS OTHERWISE SPECIFIED:  
 一般公差

10 ≥	± 0.2
30 ≥	> 10 : ± 0.25
	> 30 : ± 0.3
ANGLE	3°

THIS DRAWING IS A CONTROLLED DOCUMENT.

DIMENSIONS: mm	TOLERANCES UNLESS OTHERWISE SPECIFIED:	DWN S.FUJITA 09DEC08	TE Connectivity
	0 PLC ± -	CHK K.BETSUI 09DEC08	
	1 PLC ± -	APVD K.BETSUI 09DEC08	
	2 PLC ± -	PRODUCT SPEC	
MATERIAL PBT	FINISH -	APVD K.BETSUI 09DEC08	NAME 070 SERIES MULTILOCK CONNECTOR 20POSITION PULG HOUSING
		APPLICATION SPEC	SIZE CAGE CODE DRAWING NO RESTRICTED TO
		WEIGHT 7.8 g	A3 00779 C-174952
		CUSTOMER DRAWING	SCALE 2:1 SHEET 1 OF 1 REV E5

## 070 SERIES MULTI-LOCK I/O CONNECTOR

## 070 シリーズ マルチロック I/O コネクタ

## 1. 適用範囲

## 1.1 内容

本規格は、.070 シリーズ・マルチロック I/O コネクタ (MLC) の製品性能、試験方法、品質保証の必要条件を規定している。  
適用製品名と型番は付表 1 の通りである。

## 2. 参考規格類

以下規格類は本規格中で規定する範囲内に於いて、本規格の一部を構成する。万一本規格と製品図面の間に不一致が生じた時は、製品図面を優先して適用すること。万一本規格と参考規格類の間に不一致が生じた時は、本規格を優先して適用すること。

## 2.1 規格 AMP

- A. 109-5000 : 試験法の一般条件
- B. 114-5091,5092 : 取付適用規格  
「070 シリーズリセ及びタブ  
コンタクト圧着規格」
- C. 501-5051 : 試験報告書

## 2.2 民間団体規格

- A. JASO D605 : 自動車多極のコネクタ
- B. JASO D7101 : プラスチック成形部品の試験方法
- C. JIS C3406 : 自動車用低圧電線
- D. JIS D0203 : 自動車部品の耐湿及び耐水試験方法
- E. JIS D0204 : 自動車部品の高温及び低温試験方法
- F. JIS D1601 : 自動車部品振動試験方法
- G. JIS R5210 : ボルトランド・セメント
- H. MIL-STD-202 : 試験方法 208 : はんだ付け法

## 1. Scope

## 1.1 Contents

This specification covers the requirements for product performance, test methods and quality assurance provisions of 070 SERIES MULTI LOCK I/O CONNECTOR(MLC).

Applicable product description and part numbers are as shown in Appendix.1.

## 2. Applicable Documents

The following documents form a part of this specification to the extent specified herein . In the event of conflict between the requirements of this specification and the product drawing, the product drawing shall take precedence. In the event of conflict between the requirements of this specification and the referenced documents, this specification shall take precedence.

## 2.1 AMP Specifications

- A. 109-5000 : Test Specification, General Requirements for Test Methods.
- B. 114-5091,5092 : Application Specification  
“070 Series Receptacle and Tab  
Contact Application Specification.”
- C. 501-5051 : Test Report

## 2.2 Commercial Standards and Specifications

- A. JASO D605 : Multi-pole connector for Automobiles
- B. JASO D7101 : Test Method for Plastic Molded Parts
- C. JIS C3406 : Low Voltage wires and Cables for Automobile
- D. JIS D0203 : Method of Moisture, Rain and Spray Test for Automobile Parts
- E. JIS D0204 : Method of High and Low Temperature Test for Automobile Parts
- F. JIS D1601 : Vibration Testing Method for Automobile Parts
- G. JIS R5210 : Portland Cement
- H. MIL-STD-202 : Test Method 208:Method Soldering

**3. 一般必要条件****3.1 設計と構造**

製品は該当製品図面に規定された設計、構造、物理的寸法をもって製造されていること。

**3.2 材料**

- A. コンタクト：コンタクトはすずめっき済又は金めっき付黄銅条及び磷青銅条

- B.ハウジング：ハウジングは PBT 樹脂

- C. その他

**3.3 定格**

使用温度範囲：-30°C~105°C

**3.4 性能必要条件と試験方法**

製品は Fig.2 に規定された電氣的、機械的、及び耐環境的性能必要条件に合致するよう設計されていること。試験は特別に規定されない限り室温下で行われること。

**3. Requirements****3.1 Design and Construction**

Product shall be of the design, construction and physical dimensions specified in the applicable product drawing.

**3.2 Materials**

- A. Contact :

Tab contact: Pre-tinned brass, or Plain brass with selective gold plating over nickel under plate  
Receptacle contact: Pre-tinned phosphor bronze and brass strip, or plain phosphor bronze and brass strip with selective gold plating over nickel under plate

- B. Housing : Polybithylene terephthalate resin(PBT)

- C. Others

**3.3 Ratings**

Temperature Rating: -30°C to 105°C

**3.4 Performance and Test Descriptions**

The product shall be designed to meet the electrical, mechanical and environmental performance requirements specified in Fig.2. all tests shall be performed in the room temperature, unless otherwise specified.

**3.5 性能必要条件と試験方法の要約**
**Test Requirements and Procedures Summary:**

項目 Para.	試験項目 Test Items	規格値 Requirements	試験方法 Procedures
3.5.1	外観／Appearances		
3.5.1.1	製品の確認検査 Confirmation of Product	製品図面と AMP 取付適用規格の必要条件に合致していること。 Product shall be conforming to the requirements of applicable product drawing and Application Specification.	該当する検査基準書に基づいて目視、寸法、及び機能検査を行なうこと。 Visually, dimensionally and functionally inspected per applicable quality inspection plan.
3.5.1.2	挿抜フィーリング Handling Ergonomics	コネクタ挿入引抜において異常がないこと。 No abnormalities allowed in manual mating/unmating handling.	操作：手作業 Manually operated
3.5.2	電氣的性能／Electrical Requirements		
3.5.2.1	総合抵抗 (規定電流) Termination Resistance (Specified Current)	試験電流 Test Current 1(A)	抵抗値 Resistance 初期／Initial : 3 mΩ Max. 終期／Final : 10mΩ Max.
3.5.2.2	総合抵抗 (ローレベル) Termination Resistance (Low Level)	初期／Initial : 3mΩ Max. 終期／Final : 10mΩ Max.	嵌合したコネクタの試験用回路の初期電圧降下を測定、Fig.3 参照。 Measure initial millivolt drop of contact test circuit in mated connectors, Fig.3 AMP 規格／AMP Spec : 109-5311-2
3.5.2.3	耐電圧 Dielectric Strength	沿面放電、フラッシュオーバー等がないこと。 No creeping discharge nor flash over shall occur.	1.8kVAC 1 分間印加 コネクタ嵌合あり 隣接コンタクト間で測定 1.8kVAC for 1 minute. Test between adjacent circuits of mated connectors. Fig.5 参照／See Fig.5. AMP 規格／AMP Spec : 109-5301

Fig.2 (続く／to be continued)

項目 Para.	試験項目 Test Items	規格値 Requirements	試験方法 Procedures
3.5.2.4	絶縁抵抗 Insulation Resistance	初期/Initial : 100M $\Omega$ Min. 終期/Final : 100M $\Omega$ Min.	500VDC 印加。 コネクタ嵌合あり。 隣接コンタクト間で測定  Impressed voltage 500VDC. Test between adjacent circuits of mated connectors.  AMP 規格/AMP Spec : 109-5302 Fig.5 参照/See Fig.5
3.5.2.5	リーク電流 Current Leakage	3mA Max.	12VDC60 $^{\circ}$ C 湿度 90~95% 1時間 12VDC 60 $^{\circ}$ C  Humidity 90~95% 1Hr  AMP 規格/AMP Spec : 109-5312 Fig.4 参照/See Fig.4
3.5.2.6	温度上昇 Temperature Rising	規定電流を通電して、温度上昇は 60 $^{\circ}$ C以下。  60 $^{\circ}$ C Max. under loaded specified current.	通電による温度上昇を測定すること。  Measure temperature rising by energized current.  Fig.7 参照/See Fig.7 AMP 規格/AMP Spec : 109-5310 方法/Method
3.5.3	機械的性能/Mechanical Requirements		
3.5.3.1	コンタクト挿入力 Contact Mating Force	2.9~7.8N	操作速度 100mm/分 挿入に要する力を測定  Operation Speed:100mm/min. Measure the force required to mating connectors.  AMP 規格/AMP Spec : 109-5206 条件/Condition
3.5.3.2	コンタクト引抜力 Contact Unmating Force	2~7.8N	操作速度 100mm/分 引抜に要する力を測定  Operation Speed:100mm/min. Measure the force required to unmatig connectors.  AMP 規格/AMP Spec : 109-5206 条件/Condition

Fig.2 (続く / to be continued)

項目 Para.	試験項目 Test Items	規格値 Requirements	試験方法 Procedures
3.5.3.3	コネクタ挿入力 Connector Mating Force	2 極/Pos. 29.4N Max. 3 極/Pos. 39N Max. 4 極/Pos. 39N Max. 6 極/Pos. 49N Max/ 8 極/Pos. 59N Max. 10 極/Pos. 68.6N Max. 12 極/Pos. 78.5N Max. 14 極/Pos. 88N Max. 18 極/Pos. 118N Max. 20 極/Pos. 137N Max.	操作速度 100mm/分 挿入に要する力を測定 Operation Speed : 100mm/min. Measure the force required to mate connectors. AMP 規格/AMP Spec : 109-5206 条件/Condition
3.5.3.4	コネクタ引抜力 Connector Unmating Force	2 極/Pos. 1.96~29 N 3 極/Pos. 2.94~39 N 4 極/Pos. 3.92~39 N 6 極/Pos. 5.9~49 N 8 極/Pos. 7.85~59 N 10 極/Pos. 9.8~68.8 N 12 極/Pos. 11.8~78.5 N 14 極/Pos. 13.7~88 N 18 極/Pos. 17.7~118 N 20 極/Pos. 19.6~137 N	操作速度 100mm/分 引抜に要する力を測定 Operation Speed : 100mm/min Measure the force required to unmate connectors. AMP 規格/AMP Spec : 109-5206 条件/Condition
3.5.3.5	コネクタ・ロック強度 Connector Locking Strength	98N Min.	コネクタのロック強度を測定 操作速度 100mm/分 Measure connector locking strength. Operation Speed : 100mm/min. AMP 規格/AMP Spec : 109-5210 条件/Condition
3.5.3.6	コンタクト装着力 Contact Insertion Force	14.7N Max. 1 コンタクト当たり per contact.	コンタクトをハウジングに装着するのに要する力を測定すること。 Measure the force required to insert contact into housing. AMP 規格/AMP Spec : 109-5211

Fig.2 (続く / to be continued)

項目 Para.	試験項目 Test Items	規格値 Requirements		試験方法 Procedures
3.5.3.7	コンタクト保持力 Contact Retention Force (Primary Lock)	59N Min.		コンタクト引抜力を軸方向に加えること。 操作速度：100mm/分  Apply an axial pull-off load to crimped wire. Operation Speed：100mm/min.  AMP 規格/AMP Spec：109-5212
3.5.3.8	コンタクト保持力 (二重係止) Contact Retention Force (secondary lock)	78.5N Min.		二重係止時のコンタクト保持力を測定 操作速度：100mm/分  Measure contact retention force with secondary lock set in effect. Operation Speed：100mm/min.
3.5.3.9	圧着部引張強度 Crimp Tensile Strength	電線サイズ Wire Size mm <sup>2</sup> (AWG)	引張強度 Crimp Tensile Strength(min.) N	圧着したコンタクトを試験機に固定し、軸方向引張力を電線に加える。 操作速度：100mm/分  Apply an axial pull-off load to crimped wire of contact secured on the tester. Operation Speed: 100mm/min.  AMP 規格/AMP Spec：109-5205 条件/Condition
3.5.3.10	パネル取付力 Retainer Insertion Force	$\phi 5 \pm 0.1\text{mm} \times 2\text{mm}$ (Hole) (THK)	49N Max.	操作速度 100mm/分 挿入に要する力を測定 Operation Speed:100mm/min. Measure the force required to insertion retainer.
		$\phi 7 \pm 0.1\text{mm} \times 2\text{mm}$ (Hole) (THK)	78N Max.	
3.5.3.11	パネル保持力 Retainer Retention Force	$\phi 5 \pm 0.1\text{mm} \times 0.7\text{mm}$ (Hole) (THK)	69N Min.	引抜力を軸方向に加えること。 操作速度：100mm/分 Apply an axial pull-off load to retainer. Operation Speed：100mm/min.
		$\phi 7 \pm 0.1\text{mm} \times 0.7\text{mm}$ (Hole) (THK)	147N Min.	

Fig.2 (続く / to be continued)

項目 Para.	試験項目 Test Items	規格値 Requirements	試験方法 Procedures
3.5.4	環境的性能／Environmental Requirements		
3.5.4.1	電流サイクル Current Cycling	終期／Final : 10mΩ Max. 試験中発火なきこと。 No ignition is allowed during the test.	電流条件 : F“ig.7 参照 45 分間 “ON”, 15 分間 “OFF” 200 サイクル Applied current :Fig.7 45 minutes “ON” 15minutes “OFF” 200 cycles AMP 規格／AMP Spec : 109-5308
3.5.4.2	振動 (高周波) Vibration (High Frequency)	新動中 1μsec をこえる不連続導通をしないこと。 No electrical discontinuity greater than 1μsec shall occur. 終期／Final : 10mΩ Max.	振動周波数 : 20~200 / 1 分 加速度 : 44m/s <sup>2</sup> 振動方向 : X,Y,Z 振動時間 : 各 8 時間 Vibration Frequency : 2~200/ 1 min. Accelerated Velocity : 44m/s <sup>2</sup> Vibration Direction : X,Y,Z Duration : 8 hours each AMP 規格／AMP Spec : 109-5202 Fig.6 参照／See Fig.6
3.5.4.3	物理的衝撃 Physical Shock	衝撃により 1μsec をこえる不連続導通を生じないこと。 No electrical discontinuity greater than 1μsec. shall occur.	振動周波数 : 20~200 / 1 分 加速度 : 44m/s <sup>2</sup> 振動方向 : X 振動時間 : 8 時間 Vibration Frequency: 20~200/1 Min. Accelerated Velocity : 44m/s <sup>2</sup> Vibration Direction : X Duration: 8 hours AMP 規格／AMP Space : 109-5208 Fig.8 参照／See Fig.8
3.5.4.4	耐久性 (繰り返し挿抜) Durability (Repeated Mate/Unmating)	終期／Final : 10mΩ Max.	操作速度 : 100mm / 分 挿抜回数 : 30 回 Operation Speed : 100mm/min. No. of Cycles : 30 cycles. AMP 規格／AMP Spec : 109-5213

Fig.2 (続く / to be continued)



項目 Para.	試験項目 Test Items	規格値 Requirements	試験方法 Procedures
3.5.4.5	こじり耐久性 Resistance to "Kojiri"	終期/Final : 10mΩ Max.	手指で 30 回の挿抜を行なう。 Repeated mating/unmating by hand, 30 cycles AMP 規格/AMP Spec : 109-5215
3.5.4.6	熱衝撃 Thermal Shock	終期/Final : 10mΩ Max.	-50℃/120 分、120℃/120 分 これを 1 サイクルとし 5 サイクル行なう。 -50℃/120min. 120℃/120min. Making this a cycle, repeat 5 cycles. AMP 規格/AMP Spec : 109-5103 条件/Condition
3.5.4.7	耐湿性 (定常状態) Humidity, Steady State	終期/Final : 10mΩ Max. リーク電流/ Current Leakage : 3mA Max.	嵌合したコネクタ 90~95% R.H.60℃ 48 時間 Mated Connector, 90~95% R.H.60℃ 48 hours AMP 規格/AMP Spec : 109-5105
3.5.4.8	塩水噴霧 Salt Spray	終期/Final : 10mΩ Max.	5%の塩水噴霧に 48 時間さらすこと。 MIL-STD-202,101 Subject Unmated connectors to 5% salt concentration for 48 hours: MIL-STD-202, Method 101 AMP 規格/AMP Spec : 109-5101 条件/Condition
3.5.4.9	工業ガス (SO <sub>2</sub> ) Industrial Gas (SO <sub>2</sub> )	終期/Final : 10mΩ Max.	SO <sub>2</sub> ガス 10ppm. 95% R.H. 常温 24 時間 SO <sub>2</sub> Gas: 10ppm, 95% R.H. Room temperature 24 hours AMP 規格/AMP Spec : 109-5107 条件/Condition
3.5.4.10	温度寿命 (耐熱) Temperature Life (Heat Aging)	終期/Final : 10mΩ Max.	120℃,120 時間 120℃,120 Hr. AMP 規格/AMP Spec : 109-5104 条件/Condition

Fig.2 (続く / to be continued)

項目 Para.	試験項目 Test Items	規格値 Requirements	試験方法 Procedures
3.5.4.11	耐寒性 Resistance to Cold	終期/Final : 10mΩ Max.	-50℃±5℃, 120 時間 -50℃±5℃, 120hours AMP 規格/AMP Spec : 109-5108 条件/Condition
3.5.4.12	アイシング Icing	終期/Final : 10mΩ Max.	沸騰水に浸漬を 60 分 氷結温度-30℃ Immerse in boiling water for 60 minutes, freeze at -30℃
3.5.4.13	耐塵性 Dust Bombardment	終期/Final : 10mΩ Max.	JIS R 5210 のセメント 1.5kg を 15 分毎に 10 秒拡散噴射 60 分 Subject JIS R5210 cement blow 1.5kg per 10 seconds in 15minutes intervals for 60 minutes. AMP 規格/AMP Spec : 109-5110

Fig.2(終わり/end)

**3.9 製品認定試験の試験順序**
**Product Qualification Test Sequence**

試験項目 Test Items	試験グループ / Test Group							
	1	2	3	4	5	6	7	8(c)
	試験順序 / Test Orders (a)							
試料数 / Inspection Samples Q'TY(b)	5	5	5	5	5	5	5	5
製品の確認検査 / Confirmation of Product	1	1	1	1	1	1	1,13,19	1
挿抜フィーリング / Handling Ergonomics	6			9,26		13	20	
総合抵抗 (規定電流) Termination Resistance (Specified Current)	4			4,12,15, 18,22,25	3,6,9 12,16	3,6 9,12	3,9, 12,16	
総合抵抗 (ローレベル) Termination Resistance(Low Level)	3			3,11,14, 17,21,24	2,5,8,11, 15	2,5,8,11	2,8,11, 15	
耐電圧 / Dielectric Strength				7			6,17	
絶縁抵抗 / Insulation Resistance				6			5	
リーク電流 / Current Leakage				5,19			4,18	
温度上昇 / Temperature Rising				23				
コネクタ挿入力 / Connector Mating Force	2			2				
コネクタ引抜力 / Connector Unmating Force	5			8				
コネクタ・ロック強度 Connector Locking Strength				27			14	
コンタクト装着力 / Contact Insertion Force			2					
コンタクト保持力 / Contact Retention Force				28			15	
圧着部引張強度 / Crimp Tensile Strength		2						
パネル取付力 / Retainer Mating Force								2
パネル保持力 / Retainer Retention Force								3
電流サイクル / Current Cycling				20				
振動(高周波) / Vibration(High Frequency)						7		
物理的衝撃 / Physical Shock						10		
こじり耐久性 / Resistance to "Kojiri"				10		4	7	
熱衝撃 / Thermal Shock					14			
耐湿性 (定常状態) / Humidity(Steady State)					10			
塩水噴霧 / Salt Spray							10	
工業ガス (so <sub>2</sub> ) / Industrial SO <sub>2</sub> Gas							14	
温度寿命 (耐熱) Vibration and Current Cycling					4			
耐寒性 / Temperature life(Heat Aging)					7			
アイシング / Icing				16				
耐塵性 / Dust Bombardment				13				

(a) 枠内の数字は試験を実施する順序を示す。 / Numbers indicate sequence in which tests are performed.

(b) コネクタ数 / Number of connector.

(c) パネルマウントタイプのみ適用 / Applicable to Panel Mount Type for DIA 7 and 5mm Hole only.

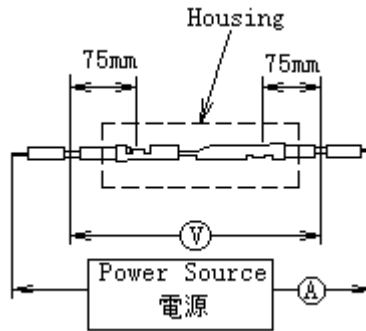

Fig.3

Wrap housing surface with metallic foil.

ハウジング表面に導体箔を巻く  
測定器

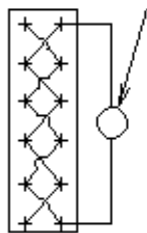
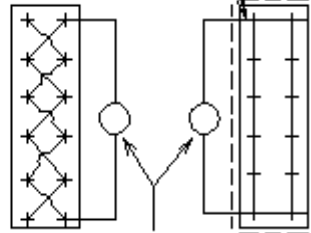
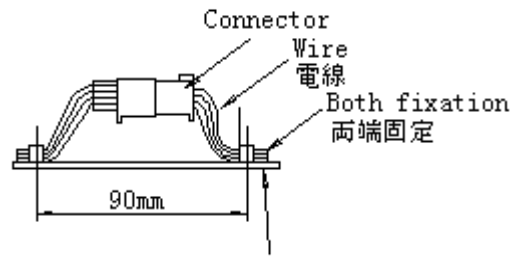

Fig.4



測定器

Fig.5



振動台

Fig.6

電線サイズ Wire Size	電流値 Current Max.
0.2mm <sup>2</sup>	DC 6A
0.3mm <sup>2</sup>	DC 8A
0.5mm <sup>2</sup>	DC 11A
0.85mm <sup>2</sup>	DC 15A
1.25mm <sup>2</sup>	DC 19A

極数 No. of Pos.	減少係数 Reduction Coefficient
1	1
2~3	0.75
4~5	0.6
6~8	0.55
9~12	0.5
13 Min.	0.4

注：通電電流は各電線サイズに対応する電流値と、極数に対応する減少係数との積から算出される。

Note : The acceptable current carrying capacity is obtained by the specified maximum coefficient obtained by the number of contacts above table.

Fig.7

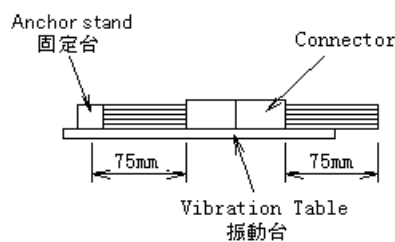

Fig.8

## 品質保証条件

## 1. 試料

性能試験に用いる試料は「070 シリーズリセプタクルコンタクトの圧着条件 114-5091,5092」に基づいて圧着した正規の試料であること。

## 2. 試験条件

特に指定のない場合は下記に示す環境条件のもとで性能試験を行なうこと。

温度：15~35℃

相対湿度：45~75%

気圧：86.7~107kPa

## Quality Assurance Provisions:

## 1. Sample Preparation

The test samples to be used for the tests shall be prepared by randomly selected from the current production, and crimped in accordance with 114-5091,5092, Application Specification, Termination of .070 Series Receptacle Contacts.  
No sample shall be reused, unless otherwise specified.

## 2. Test Conditions

All the tests shall be performed under any combination of the following test condition, unless otherwise specified.

Temperature: 15~35℃

Relative Humidity: 45~75%

Atmospheric Pressure: 86.7~107kPa

適用製品名と型番は付表 1 の通りである。

The applicable product descriptions and part numbers are as shown in Appendix 1.

付表 1/Appendix 1

Part Number	Description
173630	Receptacle Contact (0.2~0.3mm <sup>2</sup> ) S Type.
173631	Receptacle Contact (0.5~1.25mm <sup>2</sup> ) M Type.
173633	Tab Contact (0.2~0.3mm <sup>2</sup> ) S type.
173645	Tab Contact (0.5~1.25mm <sup>2</sup> ) M Type
174463	Plug Housing 2Pos.
174921	Plug Housing 3Pos.
174922	Plug Housing 4Pos.
174923	Plug Housing 6Pos.
175658	Plug Housing 6Pos.
173850	Plug Housing 8Pos.
174465	Plug Housing 10Pos.
173851	Plug Housing 12Pos.
173852	Plug Housing 14Pos.
173853	Plug Housing 18Pos
174952	Plug Housing 20Pos
174460	Cap Housing 2Pos.
174928	Cap Housing 3Pos. Panel Lock Type
174929	Cap Housing 4Pos. Panel Lock Type
174930	Cap Housing 6Pos. Panel Lock Type
175657	Cap Housing 6Pos. Panel Lock Type
174931	Cap Housing 8Pos. Panel Lock Type
174932	Cap Housing 10Pos. Panel Lock Type
174933	Cap Housing 12Pos. Panel Lock Type
174934	Cap Housing 14Pos. Panel Lock Type
174935	Cap Housing 18Pos. Panel Lock Type
174936	Cap Housing 20Pos. Panel Lock Type
174937	Cap Housing 8Pos. W/Flange
175659	Cap Housing 10Pos. W/Flange
174938	Cap Housing 20Pos. W/Flange
175709	Cap Housing 20Pos. W/Flange
178602	Cap Housing 2Pos. Panel Mount Type for DIA 7mm Hole
1318444	Cap Housing 2Pos. Panel Mount Type for DIA 5mm Hole