

THIS DRAWING IS UNPUBLISHED. RELEASED FOR PUBLICATION 2007
 © COPYRIGHT 2007 BY - ALL RIGHTS RESERVED.

LOC J DIST

REVISIONS					
P	LTR	DESCRIPTION	DATE	DWN	APVD
C1		REVISED PER ECR-12-020340	05DEC2012	E.C	H.M
C2		REVISED PER ECR-17-005500	4MAY2017	N.We	appr
ev_sym_3		REVISED PER ECR-17-009217	rev_date_3	K.T	E.T
C4		REVISED PER ECR-22-160662	27DEC2022	R.W	R.B

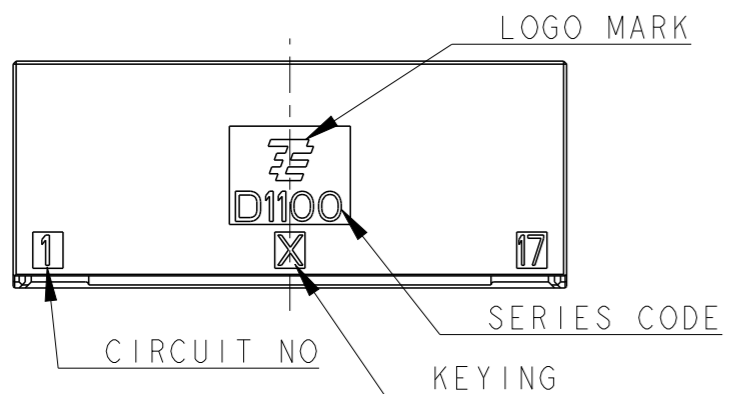
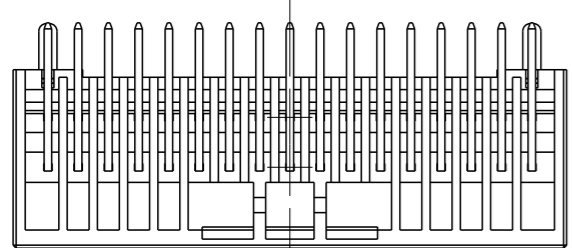
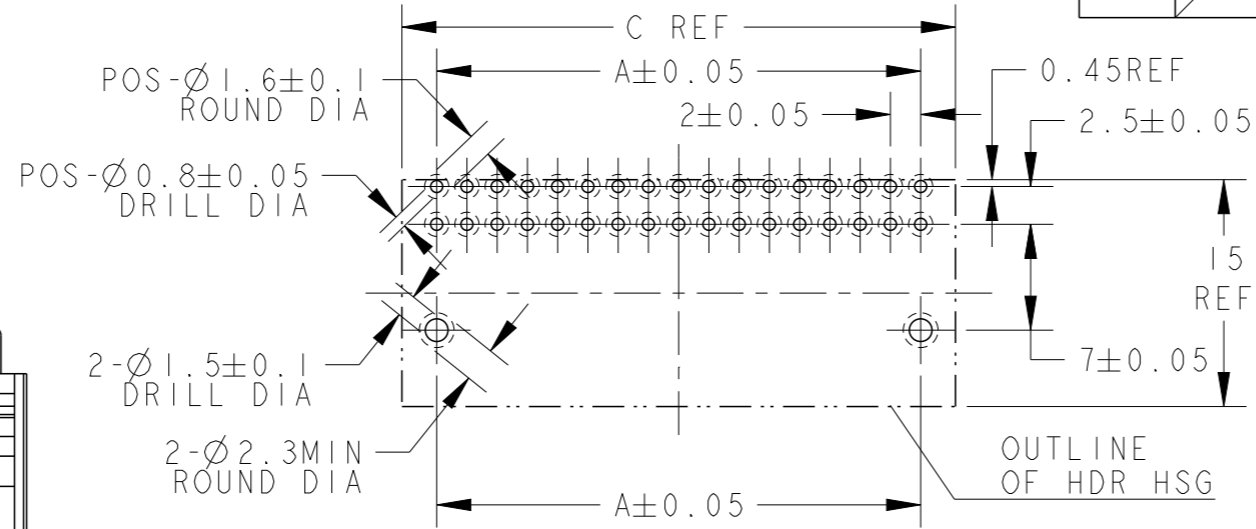

推奨基板取付寸法 : コネクタ搭載面(非累積公差)
 PC基板厚 : 1.0~1.6±0.1
 RECOMMEND PC BOARD HOLE PATTERN : CONNECTOR MOUNT SIDE (NOT ACCUMULATE TOLERANCE)
 PC BOARD THICKNESS : 1.0~1.6±0.1

勝特力電材超市-龍山店 886-3-5773766
 勝特力電材超市-光復店 886-3-5729570
 勝特力電子(上海) 86-21-34970699
 勝特力電子(深圳) 86-755-83298787
<http://www.100y.com.tw>

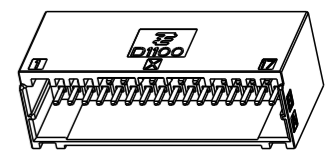

SCALE 1:1

- ①. 材料:ハウジング:ガラス入り熱可塑性ポリエステル樹脂(94V-0)、色:黒
 コンタクト:銅合金
 リテンションレグ:錫めっき済銅合金
- ②. めっき(全面):ニッケル下地めっき1.27μm以上
- ③. めっき(接触部):②の上に金めっき0.38μm以上、またはsn1.0μm MINめっき後
- ④. めっき(コンタクト半田付部):②の上に錫めっき2μm以上
- 5. 文字の形状、大きさ、および位置については、大略を示すものであり、詳細を示すものではありません。

- ①. MATERIAL:HOUSING:GLASS FILED THERMO PLASTIC POLYESTER(94V-0), COLOR:BLACK
 CONTACT:COPPER ALLOY
 RETENTION LEG:PRE-TIN COPPER ALLOY
- ②. FINISH(ALL OVER):NICKEL PLATING 1.27μmMIN
- ③. FINISH(CONTACT AREA):GOLD PLATING 0.38μmMIN OR Sn PLATING 1.0μmMIN AFTER ②
- ④. FINISH(CONTACT TAIL):TIN PLATING 2μmMIN AFTER ②
- 5. THE SHAPE, SIZE AND POSITION OF THE CHARACTER SHOW THE OUTLINE. THEY DON'T SHOW DETAILS.

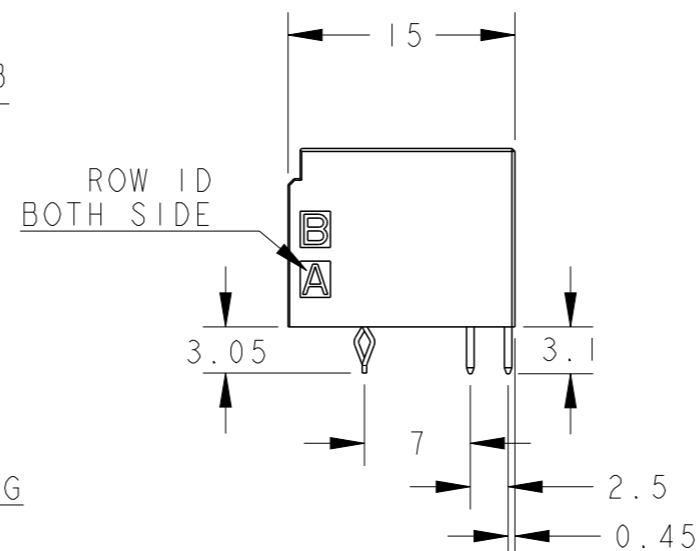
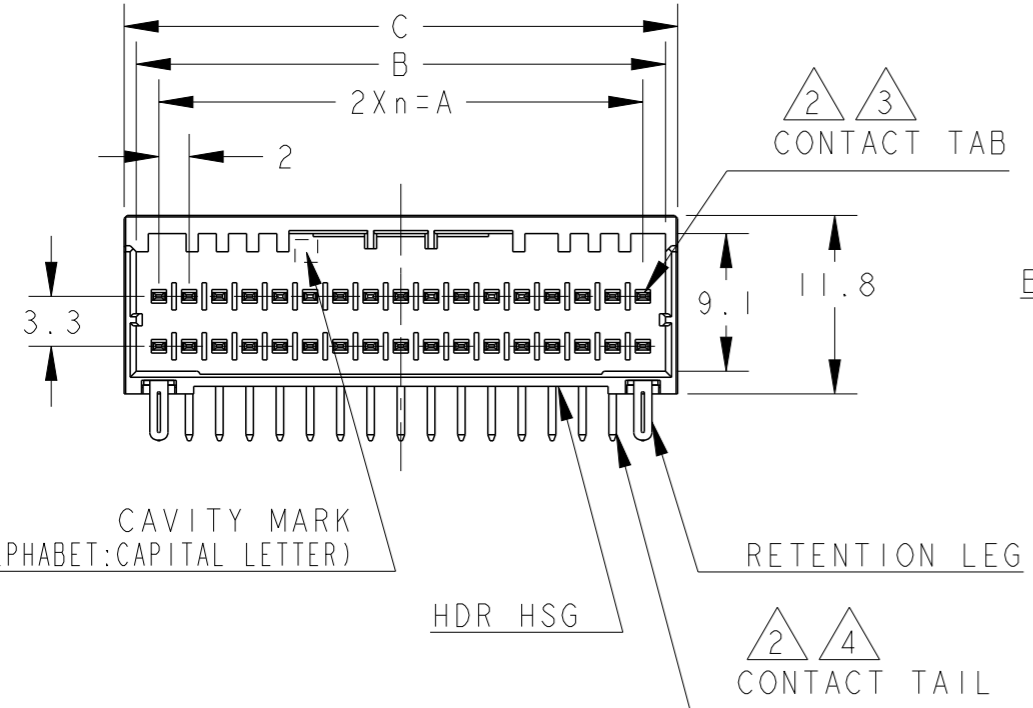

40	X	19	38.0	41.0	42.6	Sn PLATED	3-1939638-0
40	X	19	38.0	41.0	42.6	GOLD PLATED	1-1939638-0
34	X	16	32.0	35.0	36.6	Sn PLATED	3-1939638-7
34	X	16	32.0	35.0	36.6	GOLD PLATED	1-1939638-7
30	X	14	28.0	31.0	32.6	Sn PLATED	3-1939638-5
30	X	14	28.0	31.0	32.6	GOLD PLATED	1-1939638-5
28	X	13	26.0	29.0	30.6	Sn PLATED	3-1939638-4
28	X	13	26.0	29.0	30.6	GOLD PLATED	1-1939638-4
26	X	12	24.0	27.0	28.6	Sn PLATED	3-1939638-3
26	X	12	24.0	27.0	28.6	GOLD PLATED	1-1939638-3
POS	KEY	n	A	B	C	FINISHED	PART NO

34POS(X-KEY):1-1939638-7

THIS DRAWING IS A CONTROLLED DOCUMENT.

DWN M. MAEBASHI 30 JUL 2007
 CHK T. KUDO 30 JUL 2007
 APVD D. MITSUGI 30 JUL 2007

TE Connectivity

NAME DYNAMIC D1100D 2.0mmPITCH HDR ASSY, H-TYPE 22-40POS

PRODUCT SPEC 108-78268/78298
 APPLICATION SPEC 114-5377

SIZE A3 CAGE CODE 00779 DRAWING NO C-1939638 RESTRICTED TO -

Customer Drawing SCALE 2:1 SHEET 1 OF 2 REV C4

THIS DRAWING IS UNPUBLISHED.

RELEASED FOR PUBLICATION

2007

© COPYRIGHT 2007 BY -

ALL RIGHTS RESERVED.

LOC
J

DIST

REVISIONS

P	LTR	DESCRIPTION	DATE	DWN	APVD
		SEE SHEET 1 OF 2			

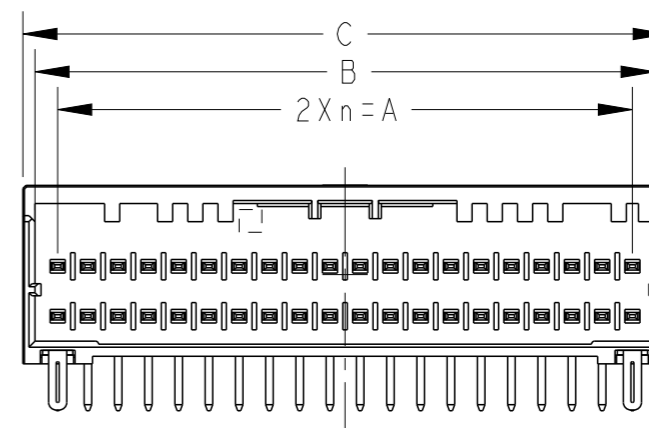
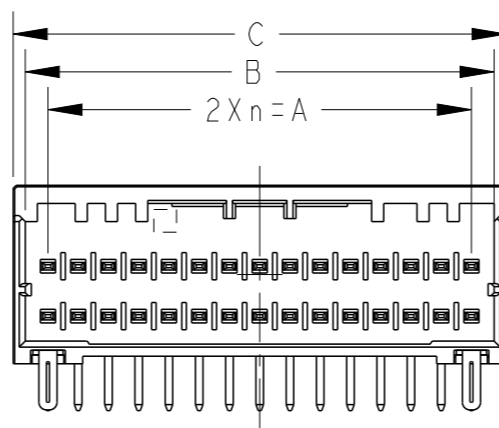
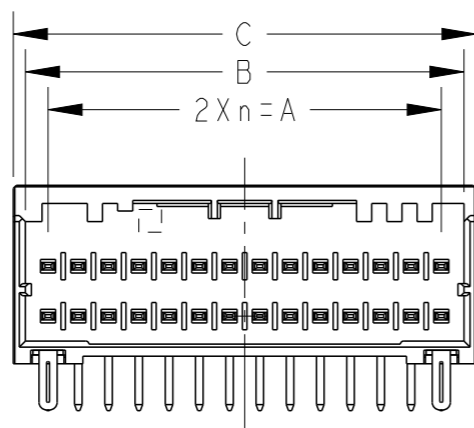
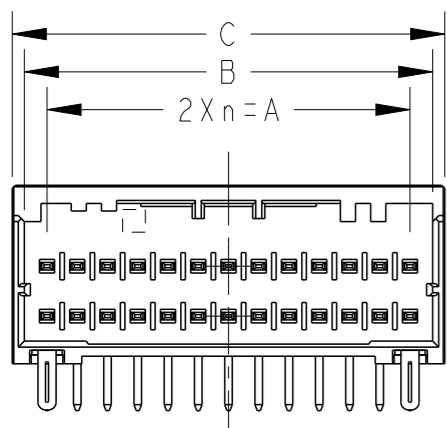
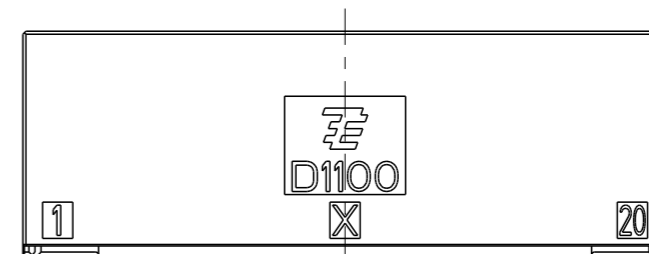
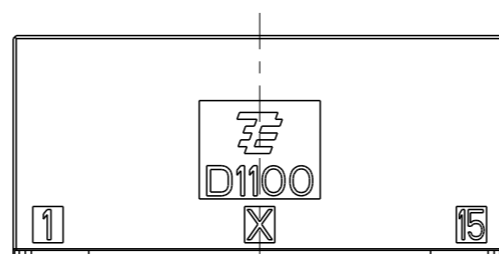
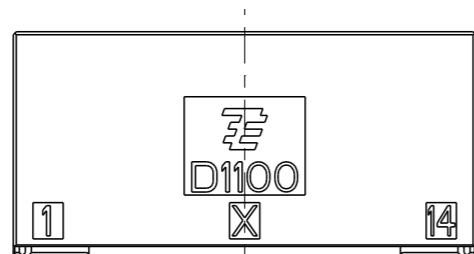
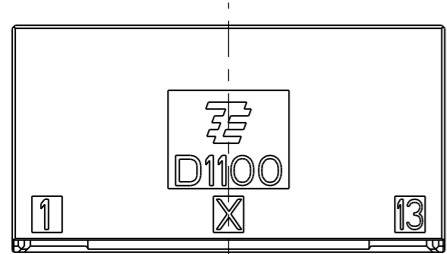
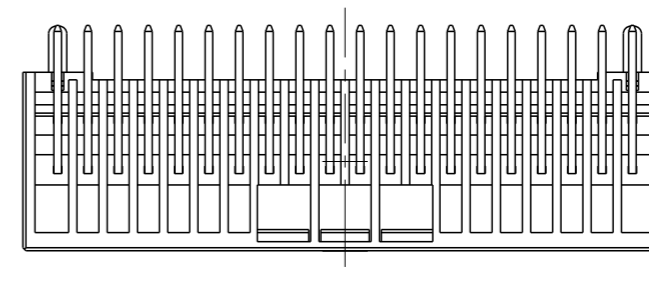
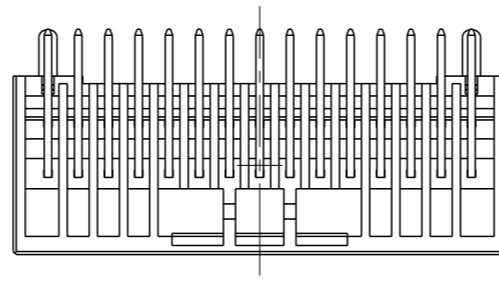
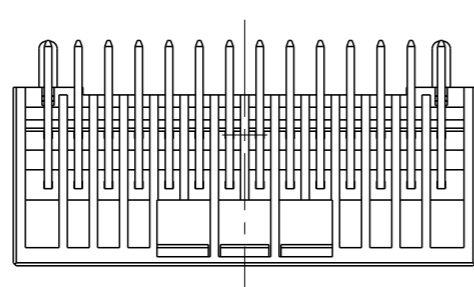
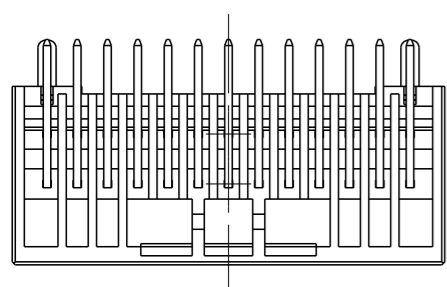

26POS(X-KEY): I-1939638-3

28POS(X-KEY): I-1939638-4

30POS(X-KEY): I-1939638-5

40POS(X-KEY): I-1939638-0

THIS DRAWING IS A CONTROLLED DOCUMENT.

DIMENSIONS:
mm

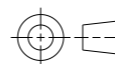

TOLERANCES UNLESS OTHERWISE SPECIFIED:

- 0 PLC ±
- 1 PLC ±0.5
- 2 PLC ±0.13
- 3 PLC ±0.013
- 4 PLC ±0.0001
- ANGLES ±

MATERIAL

FINISH

DWN M. MAEBASHI 30 JUL 2007

CHK T. KUDO 30 JUL 2007

APVD D. MITSUGI 30 JUL 2007

PRODUCT SPEC 108-78268/78298

APPLICATION SPEC 114-5377

WEIGHT



TE Connectivity

NAME
DYNAMIC D1100D 2.0mmPITCH
HDR ASSY, H-TYPE
22-40POS

SIZE	CAGE CODE	DRAWING NO	RESTRICTED TO
A3	00779	C-1939638	-

Customer Drawing

SCALE 2:1

SHEET 2 OF 2

REV C4



Quick Reference Guide DYNAMIC Series

Dynamic Series is a broad product family that provides connector solutions ranging from signal level circuitry through power circuit connectivity in a ruggedized, industrialized package. The connector family is designed for use in control system applications and is suitable for a wide range of applications requiring high density, signal and power applications.

Dynamic Series consists of wire-to-board, wire-to-panel and wire-to-wire connectors with diverse housings available to meet most applications. Standard crimp and spring clamp variations of parts are available. The standardized contacts limit the amount of application tooling required.

PRODUCT APPLICATIONS

- Industrial Control
- Human Machine Interface (HMI)
- Data Communication
- Motion & Drives
- Production Equipment
- Robotics
- Servo Drives
- Elevator/Escalator
- Power Distribution
- Industrial Process Controls
- Factory Automation Computers
- Numeric Controllers
- Variable Frequency Drives
- Switching Power Supplies

RoHS
Ready 



te.com/products/dynamicseries



FEATURES YOU EXPECT FROM THE WORLD LEADER IN CONNECTIVITY SOLUTIONS

TE makes it a practice to maintain an inventory of preferred parts so orders can be fulfilled quickly. Even with specialty or custom orders, we work to reduce lead times to facilitate effective solutions within the desired timeframe.

High Performance Contact

- Large high performance contact area prevents chance of disconnection over time
- Box contact provides three points of contact to ensure the constant flow of electricity and minimizes costly downtime associated with contact failures
- Made of high conductivity material
- Gold plated versions available

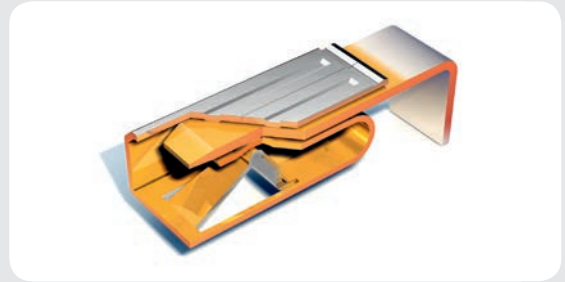

Robust Housing Structure

- Vibration resistant designed to withstand the most demanding and inhospitable environments
- Full box housing design leads to long service life and great electrical integrity
- Robust retention legs and contacts provide additional strength, acting as a strain relief and ensuring reliability
- Clear visible circuit numbers

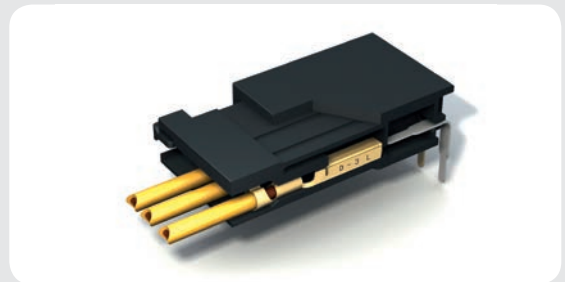

Secure & fast Installation

- Housings are keyed preventing mis-mating and mis-alignment, simplifying and reducing installation/maintenance time in the field for service engineers
- Positive audible locking sound when inserting the connector provides assurance of positive mating
- Coordinated colors & designs on both headers, receptacle housings & tools prevents human errors and increases throughput during manufacturing processes



Flexibility

- Diverse housings and different position sizes support maximum design flexibility
- Tooling options available for semi-automated termination, as well as hand tools for field termination and repair



DYNAMIC SERIES FAMILY COVERS APPLICATIONS UP TO 65A WITH VARIETY OF SUB-CATEGORIES

Its platform design is suitable for a broad range of applications requiring low level signal through high current power circuits. The centralized wiring system saves time and money by offering a modular capability to expand as needed.

PRODUCT OVERVIEW

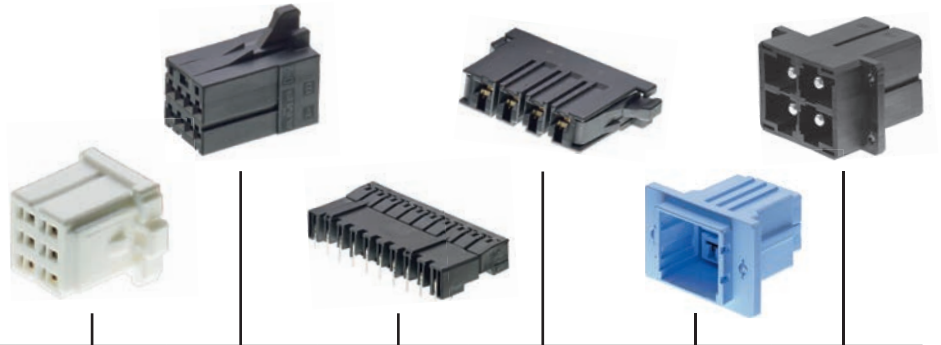

Series		D1000	D2000	D3000	D4000	D5000	D7000
Maximum Rating (A)		5	5	15	24	45	65
Maximum Rating (V)		250	250	600	600	630	630
Maximum Durability (Mating Cycles)		50	500	500	25	50	20
IP Protection Class						10, 20	20
x100	Standard	4-44 ●	3-50 ●	3-20 ●			4 ●
x200	High Voltage	2-20 ●		2-20 ●	2-6 ●	2-8 ●	
x300	Reverse					3-4 ●	4 ●
x400	Sky Scraper			12-20 ●			
x500	Module	3-36 ●		2-20 ●			
x600	Hybrid		48 ●				
x700	Motor			6 ●			
x800	HTS Module		30 ●	12 ●	8 ●	4 ●	
x900	Spring Clamp	8-38 ●		3-11 ●			
Cable Clamp		10 ●				3-4 ●	4 ●
DZ	Board to Board					3-7	
Dynatap				18-24 ●		12 ●	

Not all types of Dynamic series are shown in this guide. For a complete listing please refer to the product catalog # 1-1773732-4.
 Available Connector Position Sizes are shown in Orange
 Safety Standards: ●
 UL: E28476
 CSA: LR7189

INTRODUCING OUR TECHNOLOGICAL ACHIEVEMENTS

DYNAMIC Series offers solutions for all your industrial control needs both inside and outside the cabinet in a ruggedized, industrialized package.

SMT Type

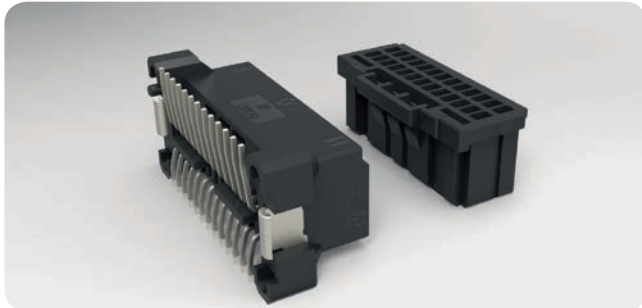

DYNAMIC SMT connectors are designed to meet the growing demand for a reliable, low cost, reflow solder capable part. Special designed retention legs increase the strength on the circuit board. The SMT type can withstand a maximum temperature of 245°C.

Surface Mount Technology (SMT)-Type	Part Number
D1100D - Board Mounted Header Assembly (26 Pos.)	1-1939995-3
D1100D - Receptacle Housing (26 Pos.)	1-1827863-3

x600 - Hybrid Type



DYNAMIC Hybrid connectors combine power and signal lines which can dramatically improve productivity by reducing assembly steps. Along with being able to mate different size wires at one time, it contributes to more compact size and makes maintenance more efficient.

Dynamic 2600 Hybrid	Part Number
D2600 - Board Mounted Header Assembly (48 Pos.)	1827538-1
D2600 - Receptacle Housing (48 Pos.)	1827540-1

x900 - Spring Clamp Type

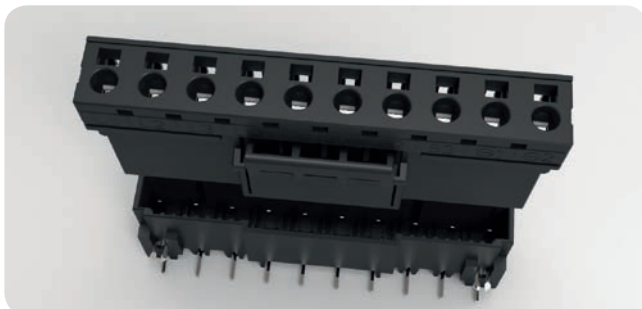

DYNAMIC spring clamp version is a screw-less, crimp-less connector. Comparing it with traditional crimping types of Dynamic, the spring clamp brings the customer a quick on-site connection with no need for crimp tooling. This is necessary for some applications where the end user must do the wiring. It provides installers a quick and easy way to terminate wires in the field which saves both time and labor. Moreover, the DYNAMIC spring clamp version has all the similar features of the existing crimp type including keying, audible locking and vibration resistance.

3900 Spring Clamp Connector*	Part Number
3900 Board Mount Header 10 Pos. X Keyed	1-2013519-0
3900 Spring Receptacle Assy 3 Pos. X Keyed	1-2134249-3
3900 Board Mount Header 3 Pos. X Keyed	1-2013519-3
3900 Spring Receptacle Assy 10 Pos. X Keyed	1-2134249-0
3900 Spring Clamp Opener Tool	1981045

5900 Spring Clamp Connector*	Part Number
5900 Board Mount Header 4 Pos. X Keyed	4-2260661-1
5900 Spring Receptacle Assy 4 Pos. X Keyed	4-2260663-1
5900 Board Mount Header 6 Pos. X Keyed	6-2260661-1
5900 Spring Receptacle Assy 6 Pos. X Keyed	6-2260663-1
5900 Spring Clamp Opener Tool	2260828-1

*Other position sizes available please refer to the product catalog # 1-1773721-4.

CONTROL CABINET APPLICATIONS

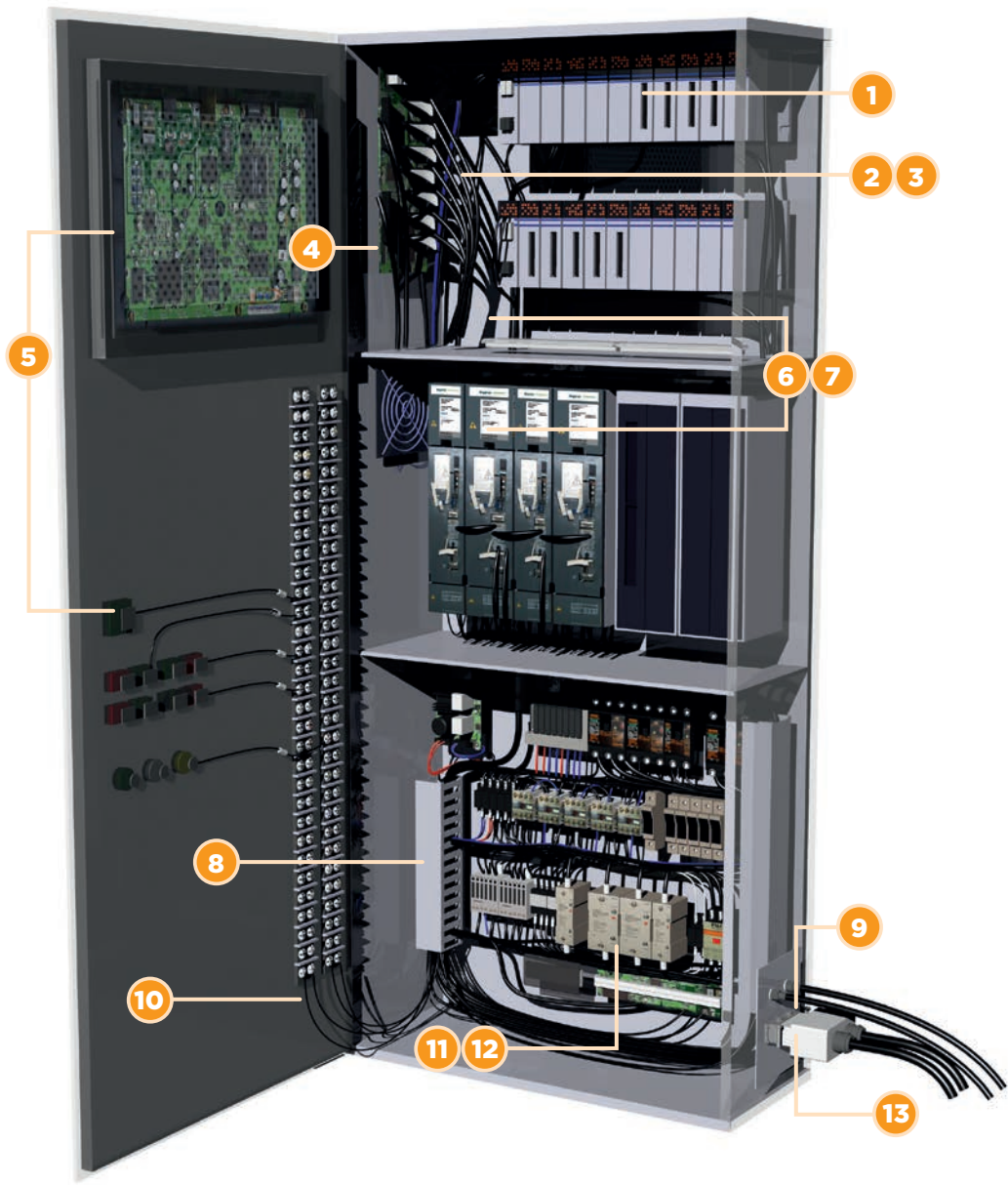

No	Application	DYNAMIC Series Product
1	Controller/PLC	D3100 Series
2	Wire to board for power application (up to 15A)	D3100 Series
3	Power Supply board-to-board	DZ5200 Series
4	Power outlet (middle power)	Dynatap 3200
5	Human Machine Interfaces	D1100 Series
6	Wire to board (multi position)	D1100 Series
7	Wire to board for signal application	D1200 Series
8	Wire to board for signal application	D2000 Series
9	Cabinet I/O and power distribution	Dynamic HTS Module
10	Sensor I/O	D1500 Series
11	Wire to board for power application (up to 30A)	D5200 Series
12	Wire to board for power application (up to 20A)	D4200 Series
13	Power outlet (high power)	D7100 Series

SIGNAL APPLICATION D-1000 SERIES

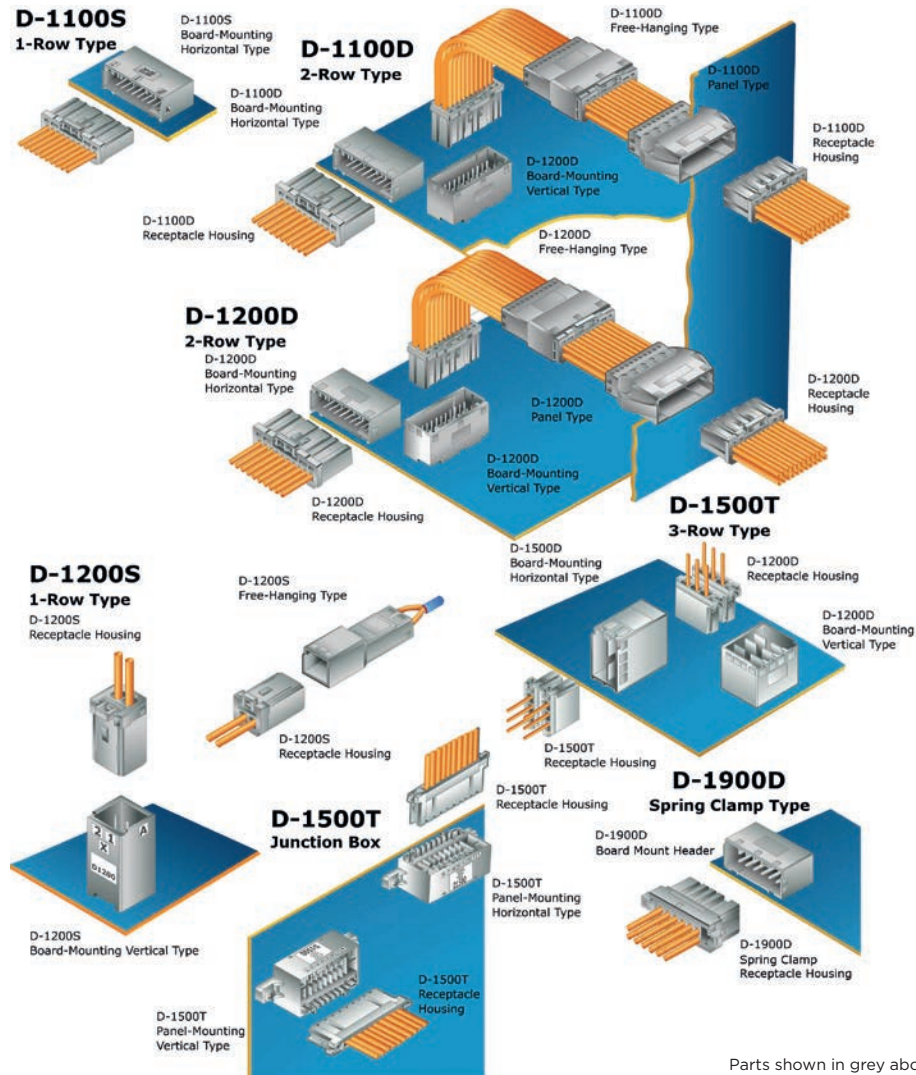

Parts shown in grey above are actually black in color

Type*	Receptacle Housing	Tab Housing	Part Number	Board Mount Header	Part Number
D-1100S 1-Row Type (10 Pos.)	1-1939758-0	Panel Type	-	Horizontal Type	1-1939760-0
		Free-Hanging Type	-	Vertical Type	-
D-1200S High Voltage 1-Row Type (2 Pos.)	1-1871465-2	Free-Hanging Type	1-1903129-2	Vertical Type	1-1871468-2
D-1100D 2-Row Type (34 Pos.)	1-1827863-7	Panel Type	1-1903128-7	Horizontal Type	1-1939638-7
		Free-Hanging Type	1-1903127-7	Vertical Type	1-1827872-7
D-1200D 2-Row Type (20 Pos.)	1-1827864-0	Panel Type	1-1903131-0	Horizontal Type	1-1827876-0
		Free-Hanging Type	1-1903130-0	Vertical Type	1-1827875-0
D-1500T 3-Row Type (6 Pos.)	1-2069029-2	Panel Type	1-2040404-2	Horizontal Type	1-1827583-2
		Free-Hanging Type	1-2040444-2	Vertical Type	1-1827581-2
D-1500T Junction Box (10 Pos.)	1971150-1	Panel Type Horizontal	1971151-1	-	-
		Panel Type Vertical	1971151-2	-	-

* Part numbers refer only to the shown position size. For different position sizes and keyings please see catalog 1-1773721-4.

Spring Clamp Type of the D-1900D (8 Pos.)*	Part Number
Receptacle Assembly (Spring Type)	1-1871940-4
Board Mount Header (Horizontal)	1-1871935-4
Board Mount Header (Vertical)	1-2013325-4
Spring Clamp Tool	1891348-1

Surface Mounted Technology (SMT)-Type**	Part Number
D1100D - Board-Mount Tab Header (40 Pos.)	1-1939995-0
D1200D - Board-Mount Tab Header (12 Pos.)	1-2013407-6

** SMT Not Pictured Above

SIGNAL APPLICATION D-2000 SERIES

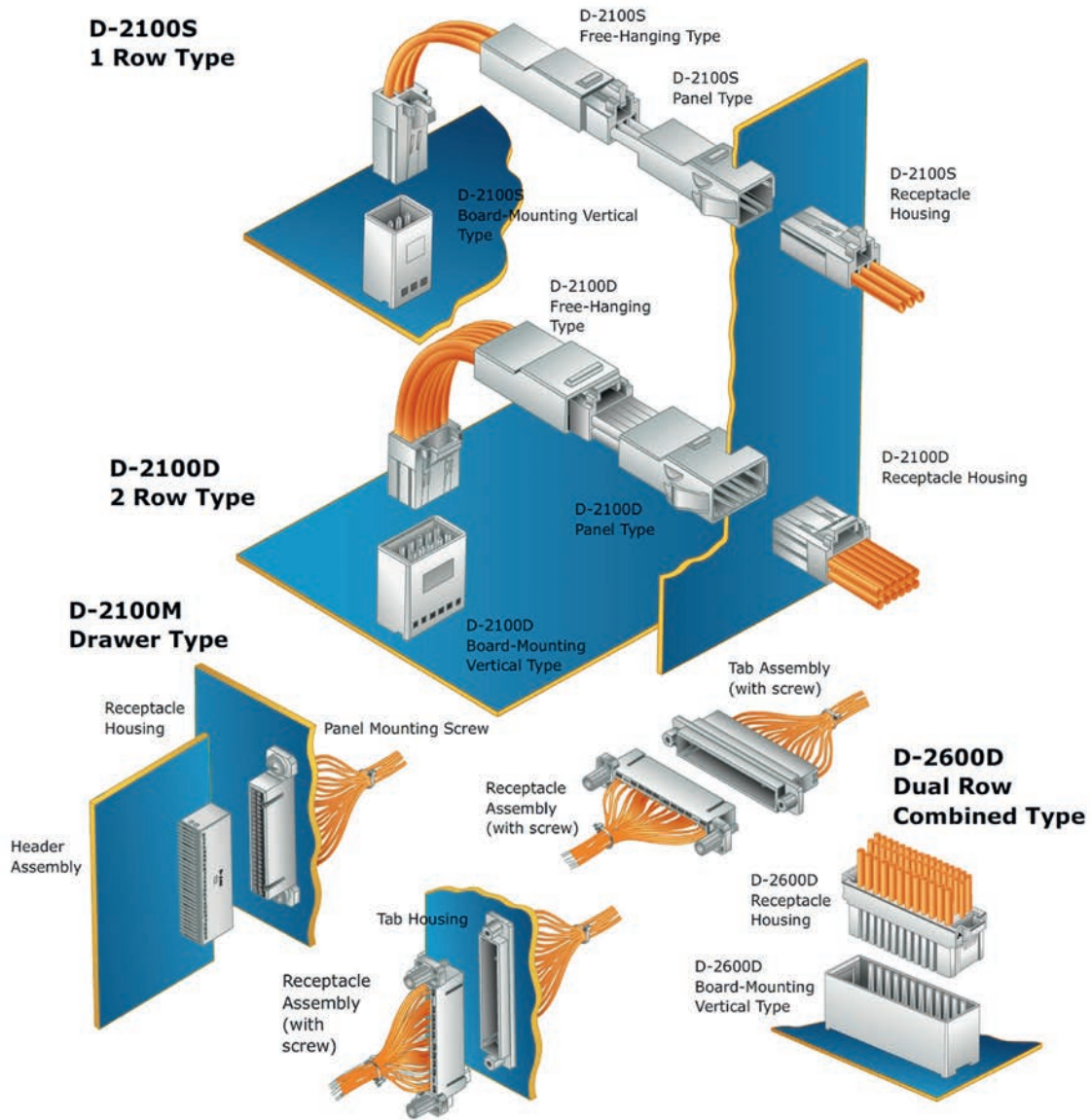

Parts shown in grey above are actually black in color

Type*	Receptacle Housing	Tab Housing	Part Number	Board Mount Header	Part Number
D-2100S 1-Row Type (3 Pos.)	1-1318120-3	Panel	1-1318116-3	Horizontal	1376135-1
		Free-Hanging Type	1-1318117-3	Vertical	1318123-1
D-2100D 2-Row Type (8 Pos.)	1-1318119-4	Panel	1-1318114-4	Horizontal	1376009-1
		Free-Hanging Type	1-1318115-4	Vertical	1318125-1
D-2600 2-Row Combined Type (48 Pos.)	1827540-1	-	-	Vertical	1827538-1

* Part numbers refer only to the shown position size. For different position sizes and keyings please see catalog # 1-1773721-4.

D-2100M Drawer Type (50 Pos.)	Part Number
Receptacle Housing	1318577-1
Board Mount Header	1318579-1
Receptacle Assembly (with screw)	1376072-2
Tab Housing Panel Type	1318578-1
Tab Assembly (with screw)	1376073-2
Panel Mounting Screw	1376059-1

SIGNAL AND POWER APPLICATION D-3000 SERIES

Used for both signal circuit and power/power supply circuit applications. Able to carry 15A MAX. of current per position and are available in a full range of connector configurations including wire to wire panel mounting, free-hanging, and horizontal and vertical wire to board-mounting.

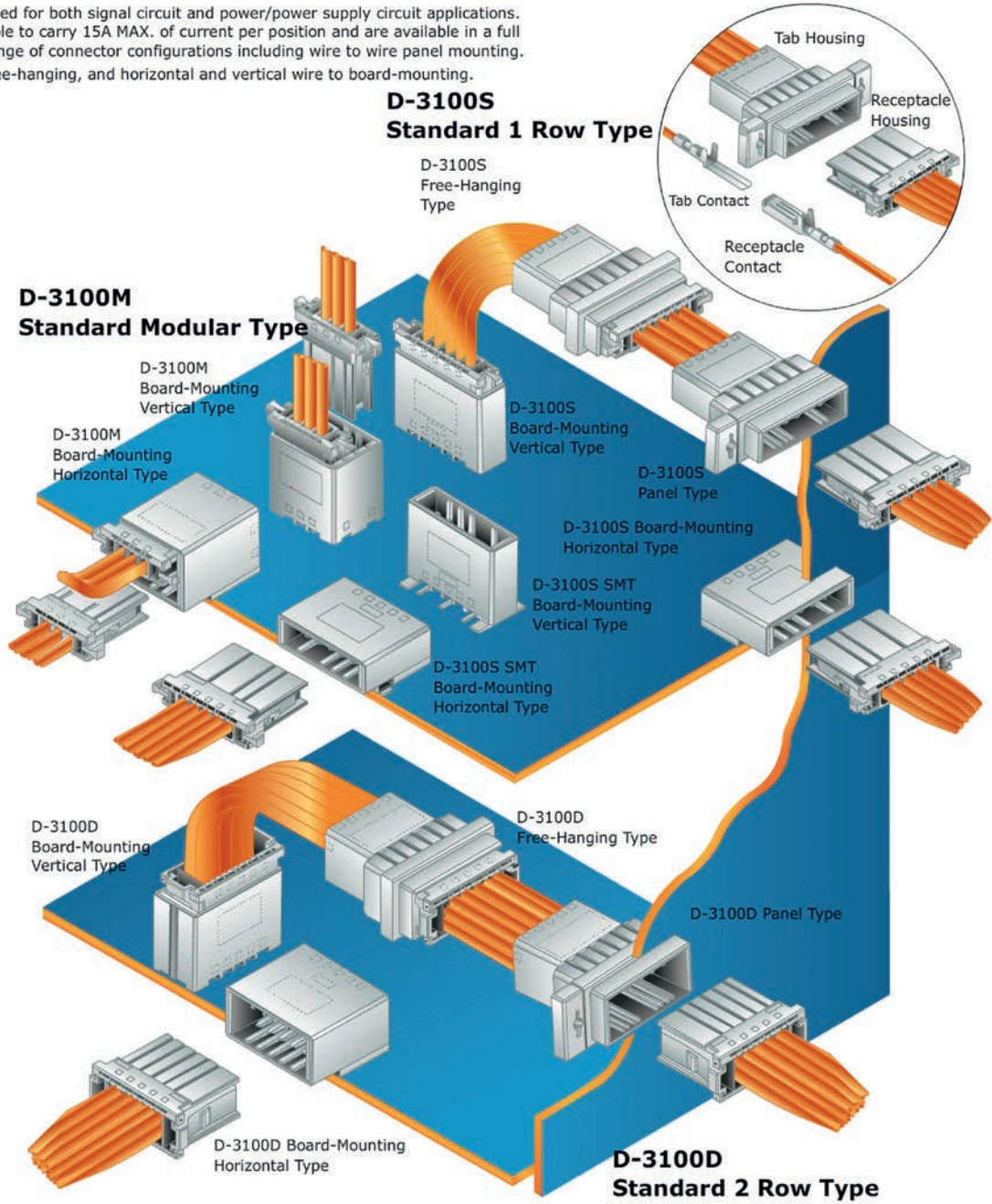

Parts shown in grey above are actually black in color

Type*	Receptacle Housing	Tab Housing	Part Number	Board Mount Header	Part Number
D-3100S 1-Row Type (3 Pos.)	1-178288-3	Panel Type	1-178802-3	Horizontal Type	1-178293-2
		Free-Hanging Type	1-177648-3	Vertical Type	1-178313-2
D-3100M Modular 2-Row Type (6 Pos.)	1-178288-3	Panel Type	-	Horizontal Type	1-178137-2
		Free-Hanging Type	-	Vertical Type	1-178141-2
D-3100D 2-Row Type (6 Pos.)	178289-3	Panel Type	178803-3	Horizontal Type	178303-2
		Free-Hanging Type	178964-3	Vertical Type	178323-2
D-3100S SMT Type (5 Pos.)	1-178288-5	Panel Type	-	Horizontal Type	1-177662-2
		Free-Hanging Type	-	Vertical Type	1-177665-2

* Part numbers refer only to the shown position size. For different position sizes and keyings please see catalog # 1-1773721-4.

SIGNAL AND POWER APPLICATION D-3000 SERIES

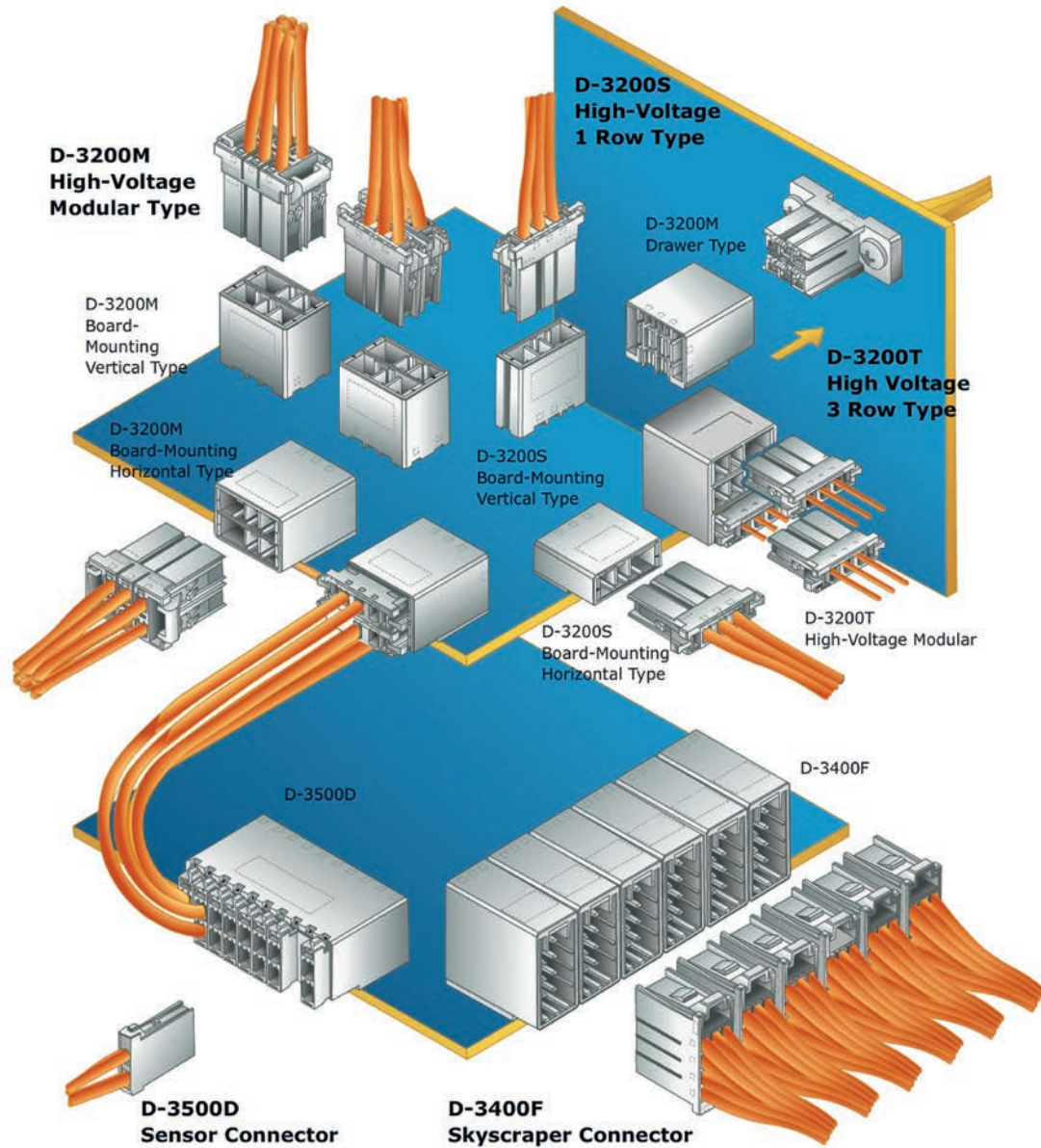

Parts shown in grey above are actually black in color

Type*	Receptacle Housing	Tab Housing	Part Number	Board Mount Header	Part Number
D-3200S High-Voltage 1-Row Type (4 Pos.)	1-178128-4	Panel Type	1-179553-4	Horizontal Type	1-179277-2
		Free-Hanging Type	1-179552-4	Vertical Type	1-917338-2
D-3200M High-Voltage Modular Type (6 Pos.)	1-178129-6	Panel Type	1-179555-3	Horizontal Type	1-178139-2
		Free-Hanging Type	1-179554-3	Vertical Type	1-178140-2
D-3200T High Pressure 3-Row Type (9 Pos.)	1-178128-3	Panel Type	-	Horizontal Type	1-1123624-2
D-3400F Skyscraper Type (20 Pos.)	917249-1	Panel Type	-	Horizontal Type	917251-2
D-3500D Sensor Connector Type (12 Pos.)	175362-1	Panel Type	917241-6	Horizontal Type	177555-2
		Free-Hanging type	917242-6	Vertical Type	316516-2
D-3700 Motor Connector**	176346-7	-	-	-	-

* Part numbers refer only to the shown position size. For different position sizes and keyings please see catalog # 1-1773721-4.

** Not Pictured Above.

POWER APPLICATION D-4000 SERIES

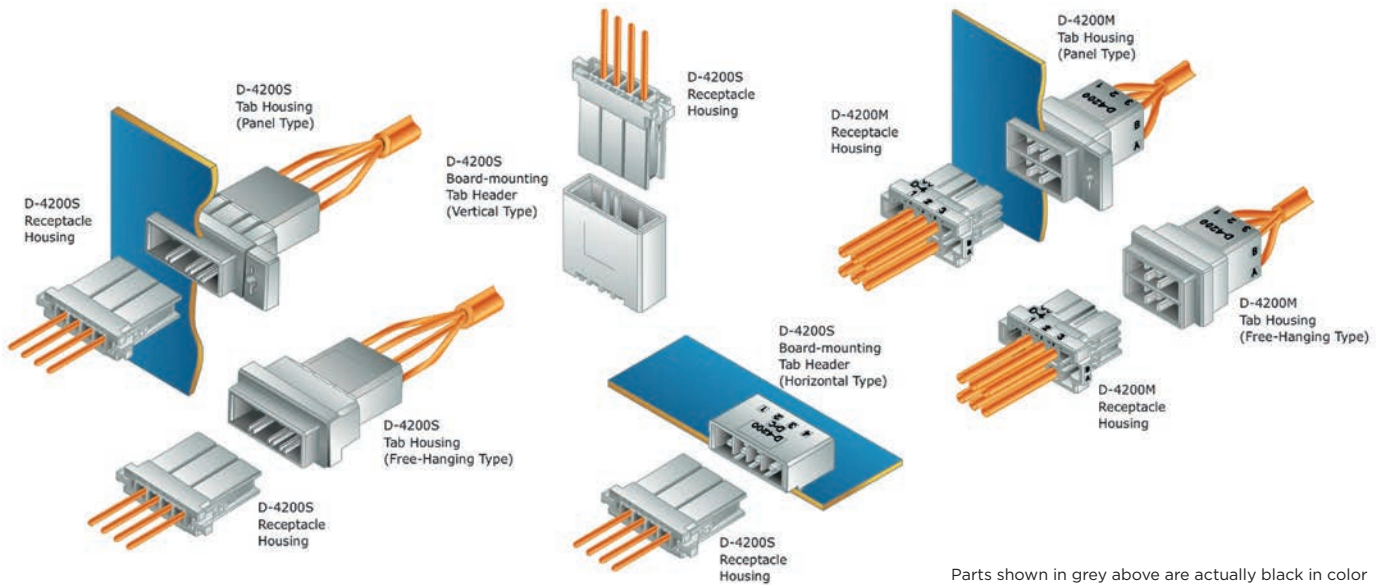

Parts shown in grey above are actually black in color

Type*	Receptacle Housing	Tab Housing	Part Number	Board Mount Header	Part Number
D-4200S High Current 1-Row Type (4 Pos.)	1-1747276-4	Panel	1-1747535-4	Horizontal	1-1903328-4
		Free-Hanging Type	1-1747414-4	Vertical	1-1747277-4
D-4200M Standard Modular 2-Row Type (6 Pos.)	1-1903329-3	Panel	1-1903331-3		
		Free-Hanging Type	1-1903330-3		

* Part numbers refer only to the shown position size. For different position sizes and keyings please see catalog # 1-1773721-4.

POWER APPLICATION D-7000 SERIES

Pin and Socket Housings

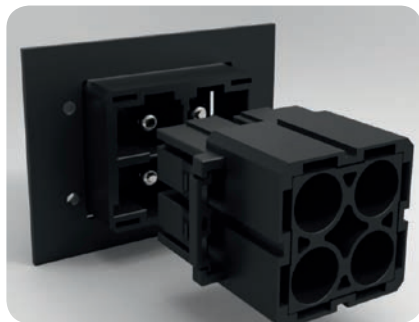

Pin Contact



Socket Contact



Type	Pos.	Part	Part Number
D-7100	4	Socket Housing	2134055-1
		Pin Housing	2134057-1
		Board Mount Header (Horizontal)	1981823-1
D-7300	4	Socket Housing	2134059-1
		Pin Housing	2134061-1
		Board Mounted Header (Horizontal)	1981823-1

AWG*	Socket Contact	Pin Contact
8	1871132-2	1871131-2

* For other AWG numbers please refer to product catalog # 1-1773721-4.

Cable Ins. Diameter	Dyna-Clamp D7100	Dyna-Clamp D7300
19-25 mm	2-2069313-1	2-2069312-1
25-31 mm	1-2069313-1	1-2069312-1

POWER APPLICATION D-5000 SERIES

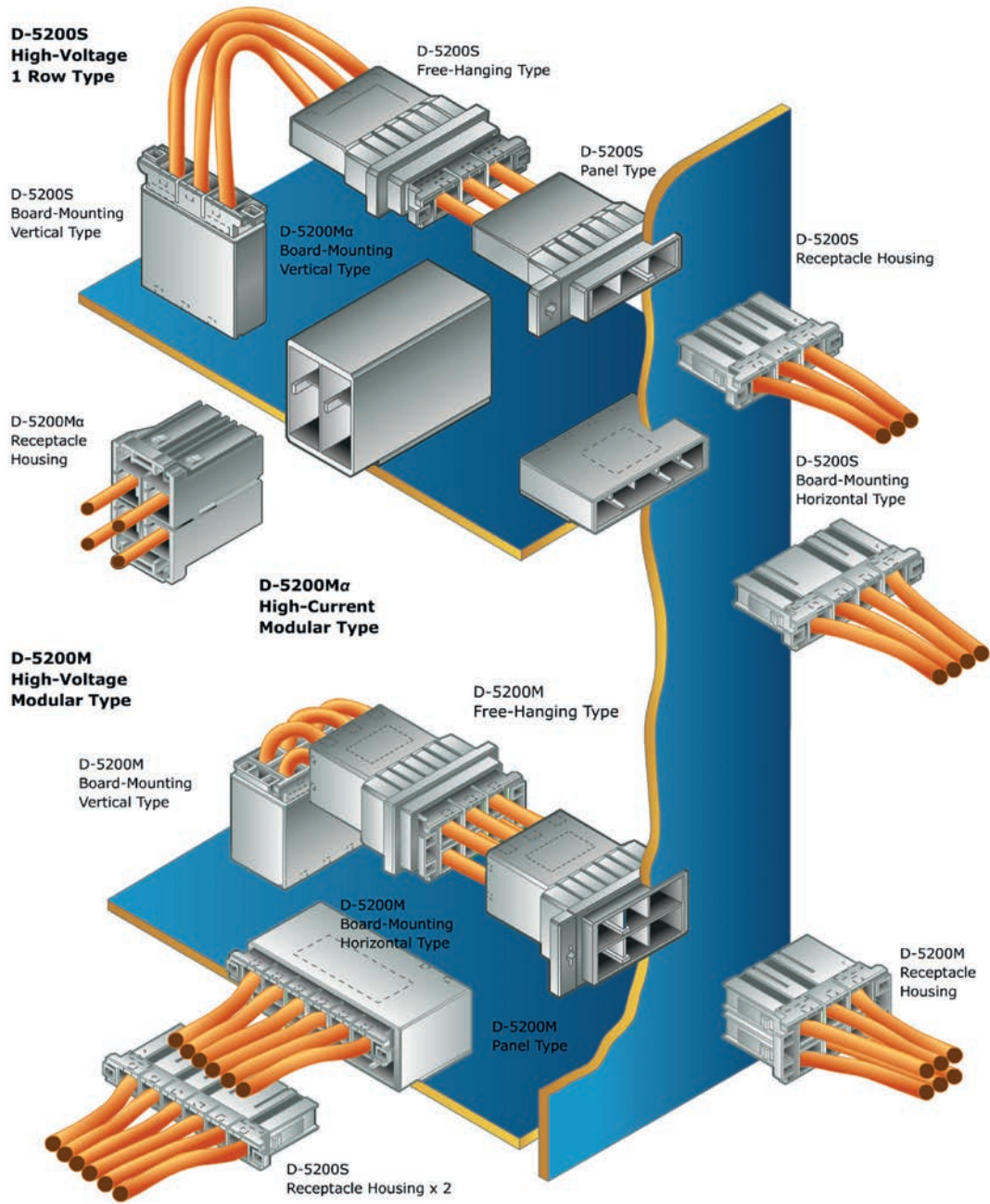

Parts shown in grey above are actually black in color

Type*	Receptacle Housing	Tab Housing	Part Number	Board Mount Header	Part Number
D-5200S High-Voltage 1-Row Type (2 Pos.)	1-179958-2	Panel	1-353047-2	Horizontal	1-353079-2
		Free-Hanging Type	1-353046-2	Vertical	1-353080-2
D-5200M High-Voltage Modular Type (4 Pos.)	1-917807-2	Panel	1-917809-2	Horizontal	1-1123309-2
		Free-Hanging Type	1-917808-2	Vertical	1-1981458-6
D-5200Ma High-Current/High-Voltage Modular Type (4 Pos.)	-	-	-	Horizontal	1-1318983-6
				Vertical	-
D-5300 Reversed Installation Type (4 Pos.)**	1-1747822-2	Free-Hanging Type	1-1747820-2	-	-

* Part numbers refer only to the shown position size. For different position sizes and keyings please see catalog # 1-1773721-4.
 ** Not Pictured Above.

APPLICATION TOOLING

DYNAMIC Series includes several tooling solutions for automated termination, manual field termination as well as wire preparation equipment. For more information about the tooling & service options please go to <http://www.te.com/en/products/application-tooling.html> and choose your region.

Hand Tools



Series*	Part Number
D-1000 Series AWG 30	2255139-1
D-2000 Series AWG 28	2255143-1
D-3000 Series AWG 28	2255146-1
D-4000 Series AWG 16	1762130-1
D-5000 Series AWG 16	91596-1
D-7000 Series AWG 16	409777-1

* Tables above showing only smallest AWG sizes available. For different sizes and part numbers please see catalog # 1-1773721-4.

Mini Application Tools



Series*	Part Number
D-1000 Series AWG 30	2114042-2
D-2000 Series AWG 28	2151240-1
D-3000 Series AWG 28	2088631-2
D-4000 Series AWG 16	1762120-2
D-5000 Series AWG 20	1528106-2
D-7000 Series AWG 12	Not Applicable

AMP-3K/40 and AMP-5K/40 Terminating Machines



Model	Part Number
AMP 3K - Universal Mounted	1725950-3
AMP 5K - Universal Mounted	1725900-3
AMP 3K - Quick Mounted	1-1725950-2
AMP 5K - Quick Mounted	1-1725900-2

Request Catalog # 1654856 for specifications and part numbers

AMP-O-LECTRIC Model G Terminating Machine



Model	Application using Crimp Quality Monitoring	Application NOT using Crimp Quality Monitoring
Terminator with Manual Crimp Adjust	1-356462-4	356462-2
CQM II Kit	2161280-1	Not Applicable

Request Catalog # 889021 for specifications and part numbers

PRODUCT AND APPLICATION SPECIFICATIONS OVERVIEW

For product samples and more information about how to use the document numbers below go to www.te.com or www.te.com/products/dynamicseries.

Series	Designation	Description	Product Specification	Application Specification	
1000	1100S	Standard 1-Row	108-78268 (Gold Plating) 108-78298 (Tin Plating)	114-5377	
	1100D	Standard 2-Row			
	1100 SMT	Surface Mount	108-78414		
	1200S	High Voltage 1-Row	108-78268 (Gold Plating) 108-78298 (Tin Plating)		
	1200D	High Voltage 2-Row			
	1500T	Junction Box			
	1900	Spring Clamp	108-78336		
2000	2100S	Standard 1-Row	108-5619	114-5258	
	2100D	Standard 2-Row			
	2100M	Drawer	108-5659		
	2600D	Hybrid of Power and Signal Line	108-78301		
	2800	HTS Module	108-78284		
3000	3100S	Standard 1-Row	108-5349	114-5148	
	3100D	Standard 2-Row			
	3100M	Standard Modular			
	3200S	High Voltage 1-Row			
	3200M	High Voltage Modular			
	3200T	High Voltage 3-Row			
	3400F	Skyscraper Connector			
	3500D	Sensor Connector			
	3700	Motor Connector			
	3800	HTS Module			108-78285
	3900	Spring Clamp			108-78400
	3950	Spring Clamp	108-78997		
4000	4200S	Standard	108-78182	114-5369	
	4200M	Module			
	4800	HTS Module	108-78388		
5000	5200S	Standard	108-5453	114-5206	
	5200M	High Voltage			
	5200Ma	High Current			
	5300S	Reversed Housing 1-Row	108-78389		
	5300D	Reversed Housing 2-Row			
	5800	HTS Module	108-78389		
	DZ-5200	Board to Board	108-78186		-
5900	Spring Clamp	108-140022	114-5206		
7000	7100	Standard	108-78470	114-5452	
	7300	Reversed Housing			
Special Products		Dynamic Pneumatic	108-78406	-	
		Multiple Enclosure	108-78417	114-5377	
		Dynatap	108-78370	114-5206	

Questions that will help you better select the product that you need:

What are the current and voltage requirements for your applications?

The Dynamic series connector family has different series that can handle between 3 and 65 amps as well as 125 volts up to 630 volts depending on the series

What is the operating temperature range for your applications?

The Dynamic Series connectors all have an operating range of -55 °C to +105 °C

Will you need additional keying configurations?

The Dynamic series are available in x,y,z,xx,yy,xy keying configurations to suit your needs.

Do you need the ability to move equipment for inspection or line changes?

The Dynamic series connectors all feature quick attach and detach housings that produce an audible click when mated. This allows for equipment to be quickly changed and removed for inspection.

Would you prefer to install wires directly into the housing instead of using crimping tools?

The Dynamic series offers both the 1900 and 3900 series which are both spring clamp versions. These versions negate the need for crimp tooling and operations. In development now are the 5900 and 2900 respective spring clamp versions of 5000 and 2000 series. Also in development is the 3950, which is the new version of the 3900 spring clamp parts.

Do you need a connection that is rugged and vibration resistant?

The Dynamic series is an extremely rugged connector family and features full box contacts with 3 points of contact for high electrical reliability.

FOR MORE INFORMATION

TE Technical Support Center

Internet:	te.com/help	Holland:	+31 73-6246999	Poland:	+48 22-4576750
Australia:	+86 400-820-6015	Hungary:	+36 1-2892040	Portugal:	+34 91-6630420
Austria:	+43 1-9056-0	India:	+86 400-820-6015	Russia:	+74 95-790-790-2200
Belgium:	+31 73-6246999	Ireland:	+1 800-882-391	Slovakia:	+42 02-720-11102
Brazil:	+55 11-2103-6000	Italy:	+39 011-4012632	Slovenia:	+38 615-602-132
Canada:	+1 905-475-6222	Japan:	+044-844-8052	South Africa:	+97 150-457-0806
China:	+86 400-820-6015	Korea:	+02-3415-4607	Spain:	+34 932-910-330
Czech Republic:	+42 02-7201-1103	Latvia:	+37 2-6778-673	Sweden:	+46 8-5072-5000
Denmark:	+46 8-5072-5000	Lithuania:	+37 037426900	Switzerland:	+41 71-447-0447
Estonia:	+37 2677-8673	Luxembourg:	+31 73-6246999	Taiwan:	+86 400-820-6015
Finland:	+46 8-5072-5000	Mexico:	+52 0 55-1106-0800	Turkey:	+90 212-282-6053
France:	+33 1-34-20-8686	Netherlands:	+31 73-6246999	United Kingdom:	+44 0800-267666
Germany:	+49 6151-607-1999	New Zealand:	+86 400-820-6015	USA:	+1 800-522-6752
Greece:	+97 1-4-347-0226	Norway:	+46 8-5072-5000		

Part numbers in this brochure are RoHS Compliant*, unless marked otherwise.

*as defined www.te.com/leadfree

te.com

© 2014 Tyco Electronics Corporation, a TE Connectivity Ltd. Company. All Rights Reserved.
1-1773721-5 IND WR 09/2014

TE Connectivity and TE connectivity (logo) are trademarks. Other logos, product and/or company names might be trademarks of their respective owners.

While TE has made every reasonable effort to ensure the accuracy of the information in this document, TE does not guarantee that it is error-free, nor does TE make any other representation, warranty or guarantee that the information is accurate, correct, reliable or current. TE reserves the right to make any adjustments to the information contained herein at any time without notice. TE expressly disclaims all implied warranties regarding the information contained herein, including, but not limited to, any implied warranties of merchantability or fitness for a particular purpose. The dimensions in this document are for reference purposes only and are subject to change without notice. Specifications are subject to change without notice. Consult TE for the latest dimensions and design specifications.

