

REVISIONS				
#	DATE	DESCRIPTION	DATE	APPV
J12		PNs 1-968855-4, 1-968857-4, 1-968859-4 OBSOLETE ON DRW.	05MAR2018	MAH. BECK
J13		Added PN 2-968851-3, 2-968853-3 2-968857-3 and 2-968859-3	07MAY2018	FRAN BECK
J14		Obsolete PN 1-968882-1/-2/-3; PN 1-968880-1/-3	11NOV2020	FRAN BECK
J15		PCN-22-152506	14SEP2022	FRAN GRIE

勝特力電材超市-龍山店 886-3-5773766
 勝特力電材超市-光復店 886-3-5729570
 勝特力电子(上海) 86-21-34970699
 勝特力电子(深圳) 86-755-83298787
<http://www.100y.com.tw>

VERSION	Ausführung	ORDER-NO. STRIP-FORM	REV	BODY	SPRING	SURFACE	WIRE SIZE RANGE	INSULATION DIAMETER	CRIMP DIMENSIONS / Crimpabmessungen mm											WEIGHT	SINGLE WIRE SEAL	TE CONNECTIVITY NO.	APPLICATION TOOLS					
									A	B	D _{DR}	C	E	D _{ISO}	F	G	H	J	K					q				
						2	12 AWG	3.0 - 3.8	4.0	4.2	2.0	5.0	5.0	3.5	3.5	5.9	7.5	0.8	21.0	0.59	828905-1	828922-1						
						8	4	3.4 - 3.7	4.5	4.7	2.3	6.0	6.0	4.3	4.3	7.0	8.5	1.25	22.6	0.65	828985-1	828986-1						
						8	1.5 - 2.5	2.2 - 3.0	3.6	3.8	1.7	5.0	5.0	3.5	3.5	6.0	7.6	0.8	21.0	0.58	828905-1	828922-1						
						8	0.5 - 1.0	1.4 - 2.1	2.5	2.7	1.2	4.8	4.8	3.3	3.0	5.6	7.2	0.75	21.0	0.54	828904-1	828922-1						
						8	0.2 - 0.5	1.2 - 1.4	2.4	2.3	1.0	4.5	4.5	3.2	2.5	5.1	6.7	0.75	21.0	0.52	828904-1	828922-1						
						8	0.2 - 0.5	1.2 - 1.4	2.1	2.1	0.8	4.5	4.5	3.2	2.5	5.1	6.7	0.75	21.0	0.52	828904-1	828922-1						
						8	4	2.7 - 3.7	4.5	4.7	2.3	5.7	5.9	3.3	4.3	6.8	8.7	0.8	22.6	0.65	-	-						
						8	1.5 - 2.5	2.2 - 3.0	3.6	3.8	1.7	4.6	5.0	2.6	3.5	5.1	6.7	0.3	20.2	0.56	-	-						
						8	0.5 - 1.0	1.4 - 2.1	2.5	2.7	1.2	3.3	3.5	1.8	3.0	4.6	6.2	0.2	20.2	0.51	-	-						
						8	0.2 - 0.5	1.2 - 1.4	2.4	2.3	1.0	2.9	2.9	1.4	2.5	3.8	5.7	0.2	20.2	0.48	-	-						
						8	0.2 - 0.5	1.2 - 1.4	2.1	2.1	0.8	2.9	2.9	1.4	2.5	3.8	5.7	0.2	20.2	0.48	-	-						

SEE APPLICATION SPECIFICATION 114-18148
siehe Verarbeitungsspezifikation 114-18148

NOTES:
Bemerkungen:

- MATING PART SEE INTERFACE DRAWING
TE-NO.: 114-18230-002
Gegensecker nach Ausführungsvorschrift
TE-Nr.: 114-18230-002
- SURFACE:
- PRE TIN PLATED 1 TO 3 µm
- GOLD PLATED MIN. 2 µm (ONLY CONTACT AREA)
- SILVER PLATED 3 TO 5 µm (ONLY CONTACT AREA)
Oberfläche:
- verzinkt 1 bis 3 µm
- vergoldet min. 2 µm (nur Kontaktzone)
- versilbert 3 bis 5 µm (nur Kontaktzone)
- DOUBLE CRIMPS ARE ONLY POSSIBLE WITH APPLICATORS AUTHORIZED BY TE (NO HAND TOOL)
SUITABLE TOOLS ON REQUEST
Doppelanschlüsse sind nur mit von TE zugelassenen Anschlagwerkzeugen möglich (keine Handzangen)
passende Werkzeuge auf Anfrage
- GAUGE INSPECTION
Lehrenprüfung
- DETAILS OF DESIGN ARE LEFT TO MANUFACTURER
Einzelheiten der Ausführung bleiben dem Hersteller ueberlassen
- ONLY GERMAN LANGUAGE VERSION SHALL BE BINDING
Massgebend ist der deutsche Text
- PUNCHING OIL RAZIOL CLF 11 SG
Stanzöl:
- "Ag+" MARKING ON SILVER PLATED VERSIONS FOR INCREASED LIMIT TEMPERATURE
"Ag+" Markierung auf versilberten Versionen fuer erhöhte Grenztemperatur
- 968880 nicht fuer Neuanwendungen, wird ersetzt durch 2141857
968882 nicht fuer Neuanwendungen, wird ersetzt durch 2141859
968880 SUPERSEDED BY PN 2141857
968882 SUPERSEDED BY PN 2141859
- Unterschiedliche Ausfuehrung und Anzahl der Serrations moeglich
DIFFERENT FORM AND NUMBER OF THE SERRATIONS POSSIBLE

THIS DRAWING IS A CONTROLLED DOCUMENT.		OWN S. Blidar	ZZSEP97	TE Connectivity PRODUCT GROUP DRAWING FOR Tabellenzeichnung fuer AMP MCP 2.8	
DIMENSIONS: mm		CHK G. Hotea	ZZSEP97		
TOLERANCES UNLESS OTHERWISE SPECIFIED: ±0.2		APPV J. Woller	ZZSEP97	NAME	
MATERIAL		FINISH		APPLICATION SPEC	
CUSTOMER DRAWING		SCALE 5:1		SHEET 1 OF 1 REV 15	

AMP MCP 2.8* Contact System
AMP MCP 2.8* Kontaktsystem

Table of contents	Page	Inhaltsverzeichnis	Seite
1 SCOPE	2	1 ANWENDUNGSBEREICH	2
2 REFERENCED DOCUMENTS	2	2 ZUSÄTZLICHE UNTERLAGEN	2
2.1 Customer Drawings	2	2.1 Kundenzeichnungen	2
2.2 Product Specification	2	2.2 Produktspezifikation	2
2.3 Application Specifications	2	2.3 Verarbeitungsspezifikationen	2
2.4 Instructional Material	2	2.4 Kundenbroschüren	2
2.5 National / International Standards	3	2.5 Nationale / Internationale Normen	3
3 DESCRIPTION	4	3 BESCHREIBUNG	4
3.1 Contacts with Insulation Crimp	4	3.1 Kontakte mit Isolationscrimp	4
3.2 Contacts for Single Wire Seal	6	3.2 Kontakte für Einzeldichtung	6
3.3 Contacts without Insulation Crimp	8	3.3 Kontakte ohne Isolationscrimp	8
4 REQUIREMENTS	9	4 ANFORDERUNGEN	9
4.1 Wire	9	4.1 Leitung	9
4.2 Cut-off and Burr	9	4.2 Trennsteg und Grat	9
4.3 Wire Crimp	9	4.3 Drahtcrimp	9
4.4 Insulation Crimp / Crimp for Single Wire Seal	10	4.4 Isolationscrimp / Crimp für Einzeldichtung	10
4.5 Contact Area	11	4.5 Kontaktbereich	11
4.6 Shape and Position Tolerances	12	4.6 Form- und Lagetoleranzen	12
5 CRIMPING DATA	15	5 CRIMPDATEN	15
5.1 Crimping Data for ISO Wires	15	5.1 Crimpdaten für ISO-Leitungen	15
5.2 Crimping Data for JASO Wires	18	5.2 Crimpdaten für JASO-Leitungen	18
5.3 Crimping Data for AWG Wires	21	5.3 Crimpdaten für AWG-Leitungen	21
6 AUXILIARY TOOLS	23	6 HILFSWERKZEUGE	23
6.1 Extraction Tool	23	6.1 Ausdrückwerkzeug	23
6.2 Assembly Tool	23	6.2 Montagehilfe	23
6.3 Dead End Plugs Assembly	23	6.3 Montage von Blindstopfen	23
REVISION RECORD	24	ÄNDERUNGSaufzeichnung	24

Only German language version is decisive.
Maßgebend ist der deutsche Text.

1 SCOPE

This specification contains the guidelines for the application of the **AMP MCP 2.8 Contact System**. The instructions are intended primarily for automatic or semi-automatic application of all versions, for wire and for single wire seal. If agreed it can also be applied to manual crimp tools.

The contacts are listed by their use, the wire size ranges and crimping data in chapter 5.

NOTE: Only the TE crimp tools specified in chapter 5 may be used for application of the contacts. Any exceptions to this rule are defined by customer specific documents.

2 REFERENCED DOCUMENTS

2.1 Customer Drawings

The dimensions and materials of the contacts are shown in the TE customer drawings **1355036**, **1719458** and **2282482**. In the case of deviations between this document and the customer drawing, the customer drawing takes precedence.

2.2 Product Specification

The product specification **108-18513** describes the characteristics of these contacts, together with the electrical and mechanical requirements.

2.3 Application Specifications

The general guidelines according to the application specifications **114-18018** and **114-18022** are valid for the crimp quality in addition.

2.4 Instructional Material

408-10389 describes the OCEAN crimping tool.

1 ZWECK

Die vorliegende Spezifikation beinhaltet die Richtlinien zur Verarbeitung des **AMP MCP 2.8 Kontaktsystems**. Die Angaben gelten primär für voll- oder halbautomatische Verarbeitung aller Ausführungen, sowohl für Leitungen als auch für Einzeldichtungen. Sie können nach Vereinbarung auch für Handcrimpwerkzeuge angewandt werden. Die Kontakte sind nach ihrer Verwendung, nach Drahtgrößenbereich und Crimpdaten in Abschnitt 5 aufgeführt.

Hinweis: Für die Verarbeitung dürfen ausschließlich die in Abschnitt 5 festgelegten TE-Werkzeuge verwendet werden. Ausnahmen sind den kundenspezifischen Unterlagen zu entnehmen.

2 ZUSÄTZLICHE UNTERLAGEN

2.1 Kundenzeichnungen

Maße und Werkstoffe der Kontakte sind den TE-Kundenzeichnungen **1355036**, **1719458** und **2282482** zu entnehmen. Bei eventuell auftretenden Abweichungen zwischen dem vorliegenden Dokument und der Kundenzeichnung sind die Daten, die in der Kundenzeichnung enthalten sind, vorrangig maßgebend.

2.2 Produktspezifikation

In der Produktspezifikation **108-18513** sind die Eigenschaften dieser Kontakte und die elektrischen und mechanischen Anforderungen beschrieben.

2.3 Verarbeitungsspezifikationen

Für die Crimpqualität gelten zusätzlich die allgemeinen Richtlinien der Verarbeitungsspezifikationen **114-18018** und **114-18022**.

2.4 Kundenbroschüren

408-10389 beschreibt das OCEAN Crimpwerkzeug.

2.5 National / International Standards

2.5 Nationale / Internationale Normen

DIN 72 551 T5/05.92	Unscreened low-tension cables with thin insulation wall (FLR) Ungeschirmte Niederspannungsleitungen mit dünnwandiger Isolierung (FLR)
DIN 72 551 T6/01.92	Unscreened low-tension cables with thin insulation wall (FLR) Ungeschirmte Niederspannungsleitungen mit dünnwandiger Isolierung (FLR)
DIN ISO 6722 T3/03.93	Unscreened low-tension cables (FLK) Ungeschirmte Niederspannungsleitungen (FLK)
DIN EN 60 352 T2/09.95	Solderless crimped connections Lötfreie elektrische Crimpverbindungen

3 DESCRIPTION

The terms shown in figures 1 to 5 are used in the specification.

3.1 Contacts with Insulation Crimp

A Locking Lance Version

3 BESCHREIBUNG

Die in den Abbildungen 1 bis 5 aufgeführten Bezeichnungen werden in der Spezifikation verwendet.

3.1 Kontakte mit Isolationscrimp

A Version mit Rastfeder

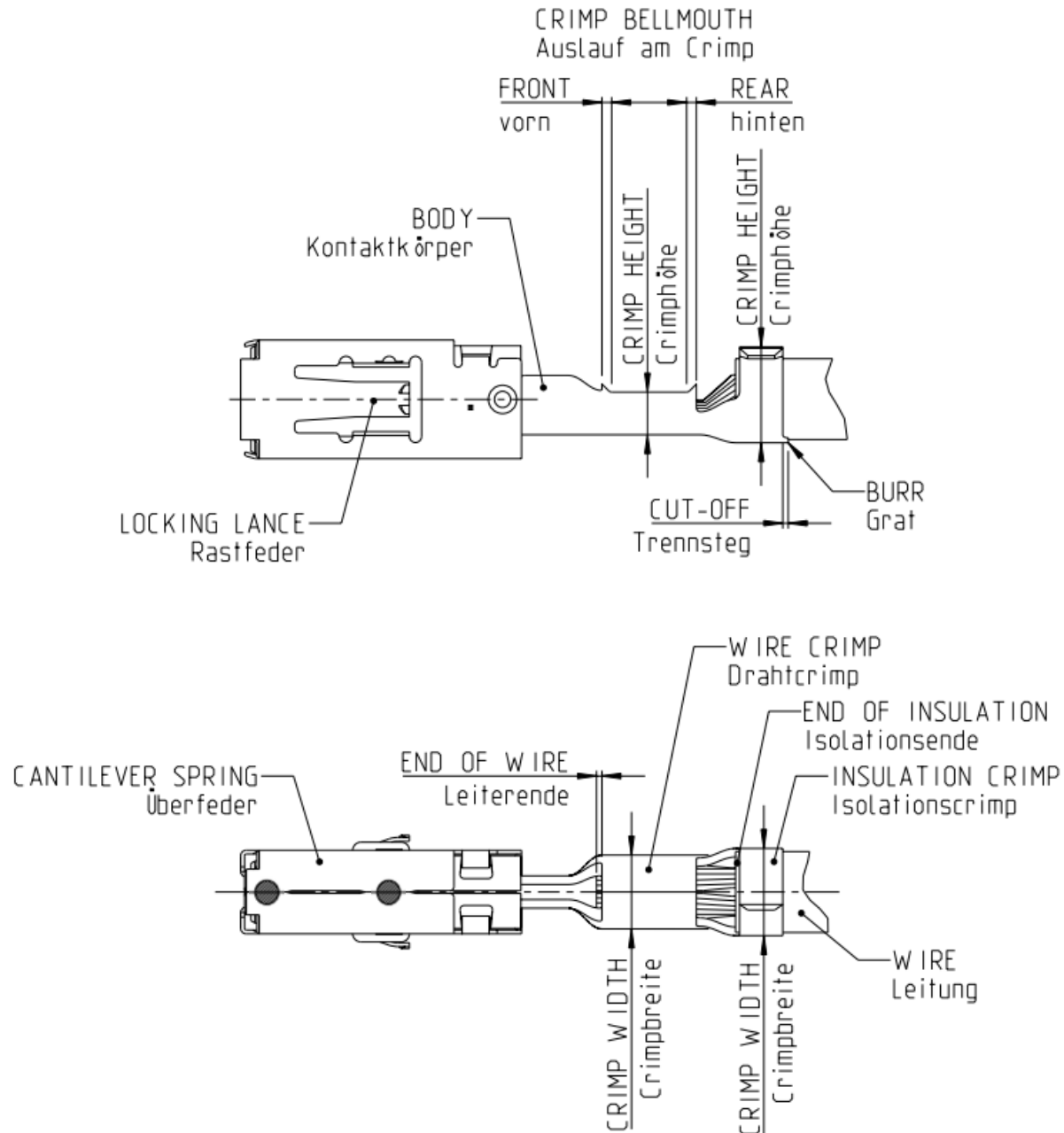

Figure 1 / Abbildung 1

B Lanceless Version

B Version ohne Rastfeder

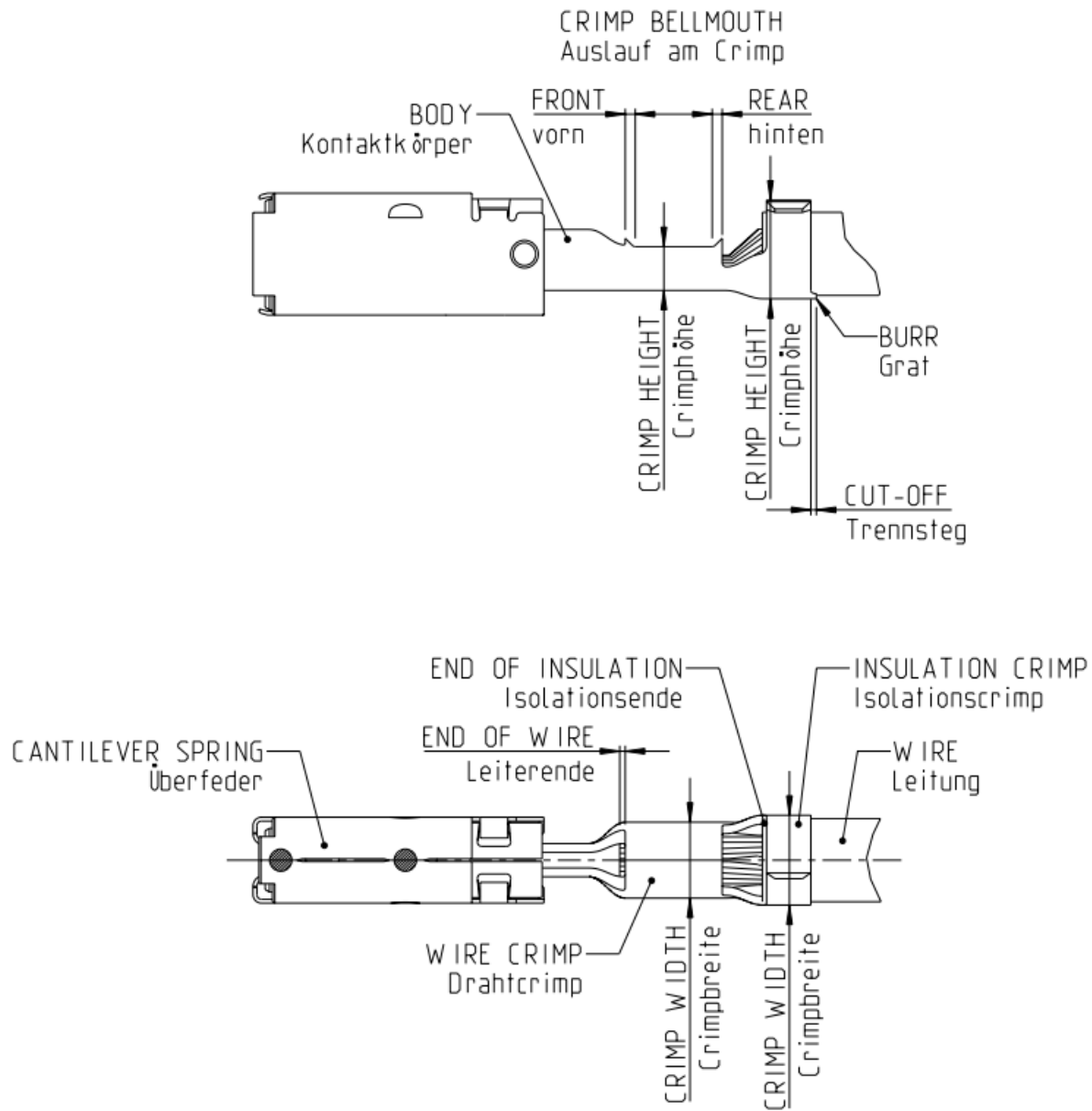

Figure 2 / Abbildung 2

3.2 Contacts for Single Wire Seal

3.2 Kontakte für Einzeldichtung

A Locking Lance Version

A Version mit Rastfeder

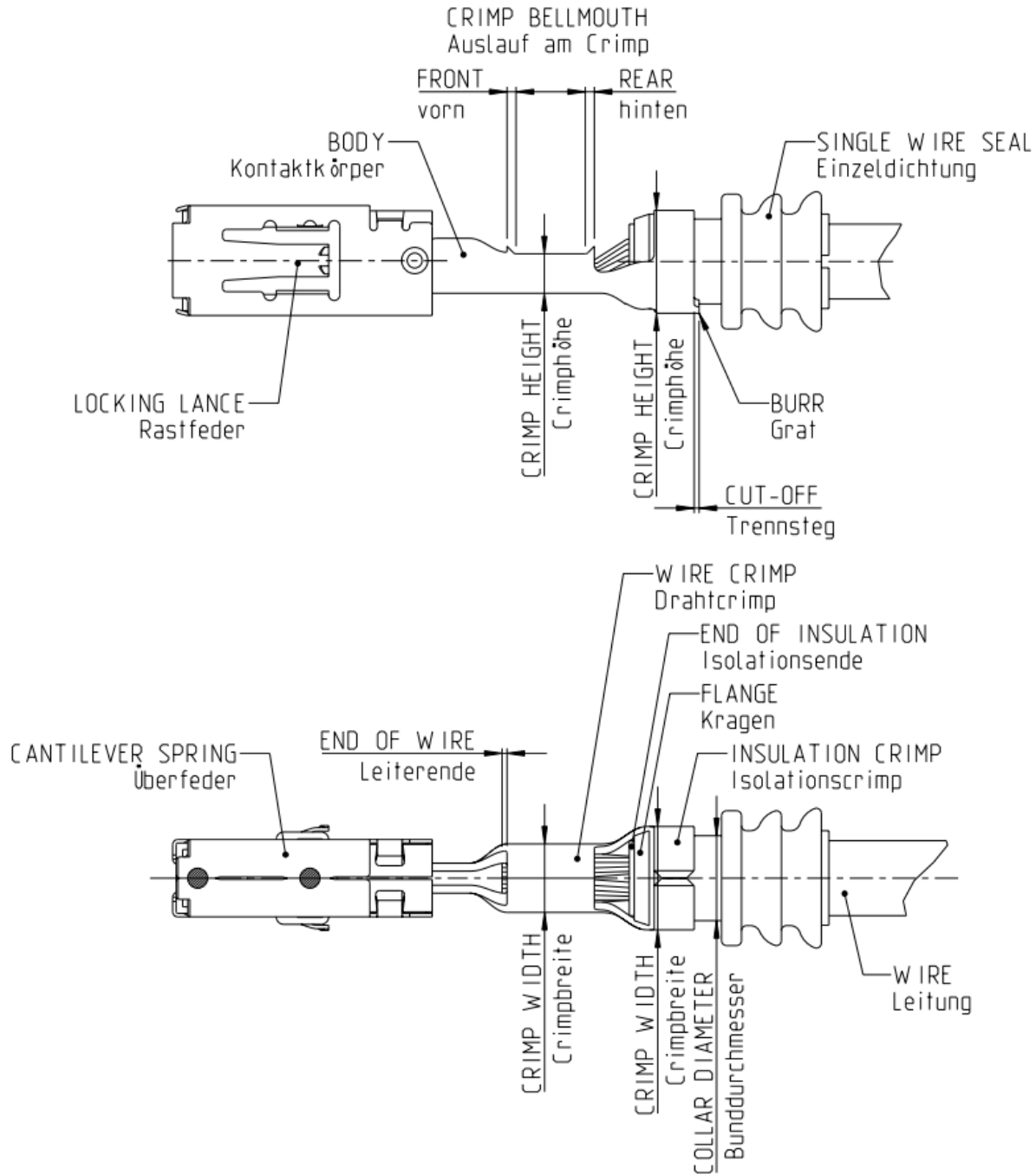

Figure 3 / Abbildung 3

B Lanceless Version

B Version ohne Rastfeder

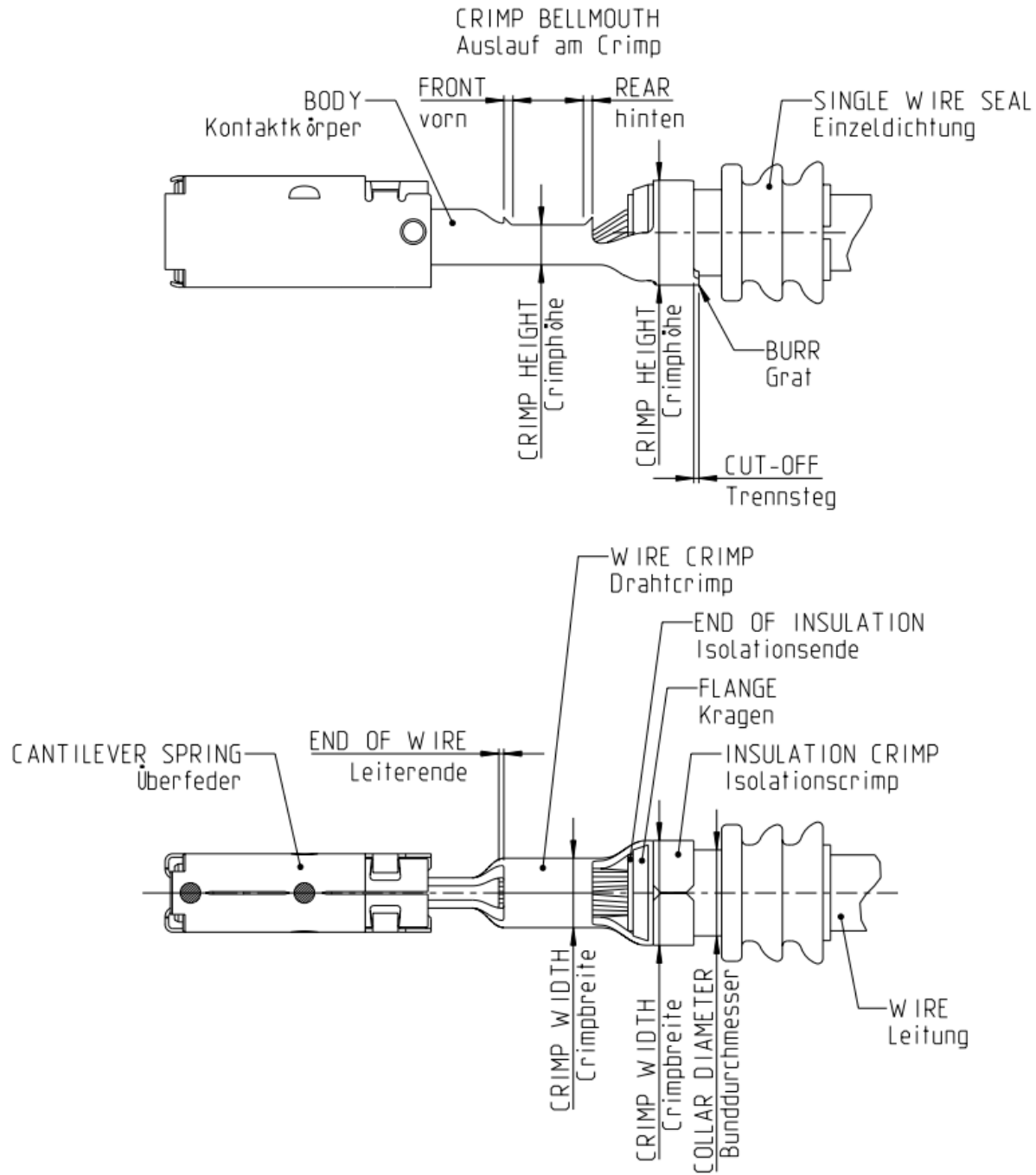

Figure 4 / Abbildung 4

3.3 Contacts without Insulation Crimp

3.3 Kontakte ohne Isolationscrimp

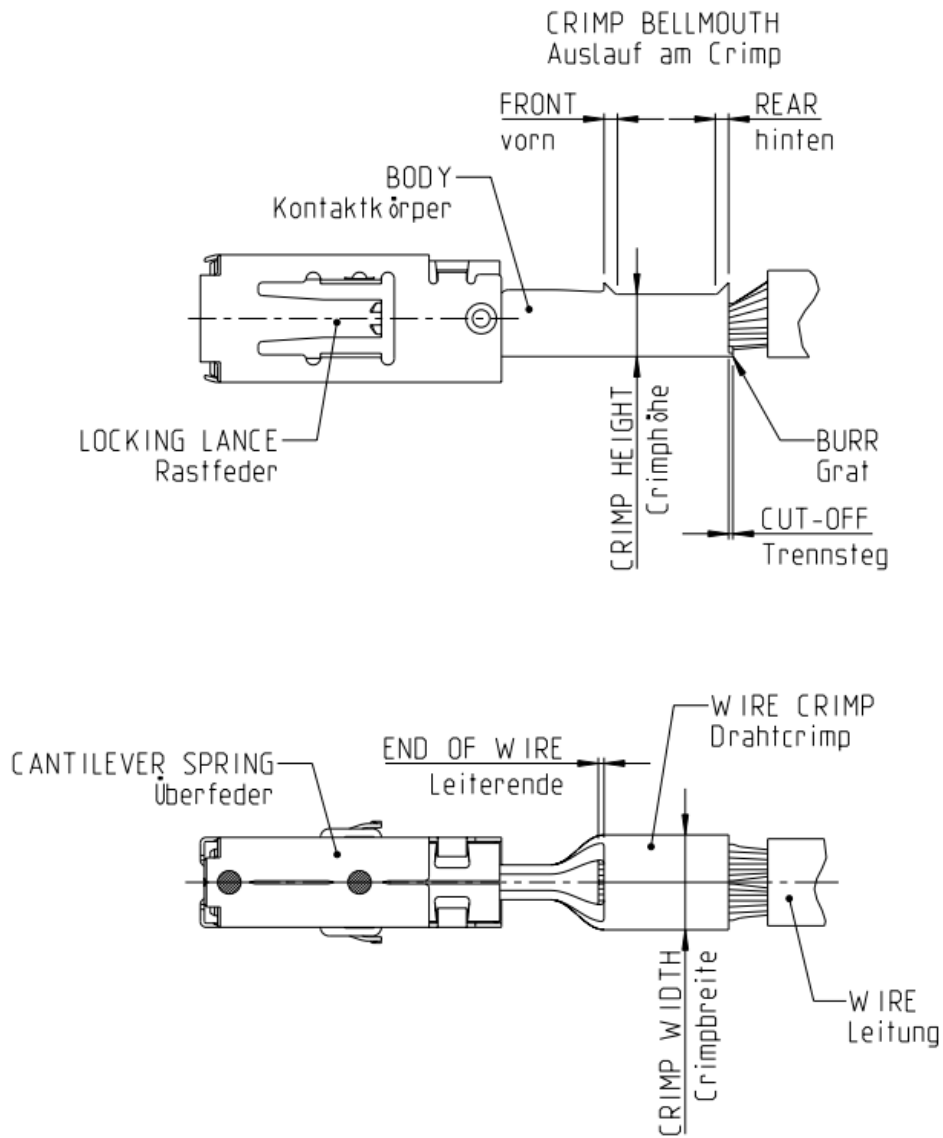

Figure 5 / Abbildung 5

4 REQUIREMENTS

4.1 Wire

A Selection

Only conductors in accordance with DIN 72 551-FLR parts 5 and 6 as well as FLR and FLU wires in accordance with LV112-1 and DIN ISO 6722 (FLK) which comply with the conditions specified in tables 1 to 3 may be used or conductors mentioned in tables 4 to 9. Other conductors require the approval of the TE development department.

Single termination is preferred. Double termination is possible only with restrictions within the wire range with FLR conductors, with FLK conductors this is possible to a very limited extent.

B Preparation

The wire must be stripped to the length shown in tables 1 to 9. Take care that the individual strands of the wire are not bent or cut off.

For single wire sealing care must be taken that the insulation of the wire in the sealing area is not damaged, compressed or deformed. The insulation must be clean and free of contamination.

4.2 Cut-off and Burr

The cut-off must be visible after crimping. Its length may not exceed 0.3mm.

The burr at the shearing point may not exceed 0.03mm.

4.3 Wire Crimp

A Wire Position

After crimping the end of the wire must extend 0.1 to 0.7mm beyond the front end of the wire crimp. In no case the end of the insulation crimp may be crimped in the wire crimp.

B Crimpind Data

The shape, height and width of the crimp, and the wire range, are shown in tables 1 to 9.

The crimp width is determined by the crimping tool and is defined as the distance between the tangent points of the two rolling radii with the vertical. The data is only a check dimension to check whether the correct tool is used. It is no quality measuring criterion.

4 ANFORDERUNGEN

4.1 Leitung

A Auswahl

Es dürfen nur Leitungen nach DIN 72 551-FLR Teil 5 und 6, sowie FLR und FLU Leitungen nach LV112-1 und DIN ISO 6722 (FLK) verarbeitet werden, die die Bedingungen nach den Tabellen 1 bis 3 erfüllen bzw. Leitungen, die in den Tabellen 4 bis 9 aufgeführt sind. Andere Leitungen benötigen die Freigabe der TE Entwicklungsabteilung.

Die Leitungen werden vorzugsweise als Einzelanschlüsse verarbeitet. Doppelanschlüsse sind innerhalb des Drahtgrößenbereichs mit FLR-Leitungen bedingt möglich, mit FLK-Leitungen sehr begrenzt möglich.

B Vorbereitung

Die Leitung wird nach den Längenangaben der Tabellen 1 bis 9 abisoliert. Einzeldrähte dürfen dabei weder beschädigt noch aufgespleißt werden. Bei der Verarbeitung mit Einzeldichtungen darf die Isolation im Dichtbereich nicht beschädigt oder gequetscht sein. Die Oberfläche muss frei von Verunreinigungen und Rückständen sein.

4.2 Trennsteg und Grat

Der Trennsteg muss nach dem Crimpvorgang noch sichtbar sein. Seine Länge darf 0,3mm nicht überschreiten.

Der Grat an der Schnittstelle darf maximal 0,03mm betragen.

4.3 Drahtcrimp

A Lage des Leiters

Das Leiterende muss nach dem Crimpen 0,1 bis 0,7mm von der Vorderkante des Drahtcrimps hervorstehen. Das Isolationsende darf keinesfalls im Drahtcrimp eingecrimpt werden.

B Crimpdaten

Die Crimpform, -höhe und- breite sowie die Leiterquerschnitte sind in den Tabellen 1 bis 9 aufgeführt.

Die Crimpbreite ist ein werkzeuggebundenes Maß und als Abstand der Tangentenpunkte beider Einrollradien zu den Senkrechten definiert. Die Angabe ist nur ein Prüfmaß, ob das richtige Crimpwerkzeug verwendet wird. Sie ist kein Qualitätsmesskriterium.

C Extraction Forces

The extraction forces must fulfil the requirements of DIN EN 60 352 part 2.

D Crimp Bellmouth

The size of the rear bellmouth depends on the wire range:

0.2 – 0.5 mm ²	:	0.25±0.15mm
>0.5 – 2.5 mm ²	:	0.40±0.20mm
>2.5 – 5.0 mm ²	:	0.60±0.30mm

A missing of the front bellmouth is permitted.

E Burr on the Base of Crimp

For the burr on the base of crimp the requirements acc. spec. 114-18022 apply.

C Ausziehkräfte

Die Ausziehkräfte müssen die Anforderungen nach DIN EN 60 352 Teil 2 erfüllen.

D Auslauf am Crimp

Der hintere Auslauf ist nach Drahtgrößenbereich gestuft:

Ein Fehlen des vorderen Auslaufs ist erlaubt.

E Grat am Crimpboden

Für den Grat am Crimpboden gelten die Forderungen gemäß Spec. 114-18022.

4.4 Insulation Crimp / Crimp for Single Wire Seal

A Position of the end of Insulation

The end of the insulation must be visible in the transition between the wire crimp and the insulation crimp. In no case the insulation may be crimped in the wire crimp and conversely the insulation must extend at least to the front edge of the insulation crimp.

B Crimping Data for Insulation Crimp

The shape and width of the crimp, and the insulation diameters are shown in tables 1, 4 and 7. The crimp height is adjusted either after the bending test or after the wrapping test to DIN EN 60 352 part 2.

C Position of the Single Wire Seal on the Wire

The end of the wire insulation must at least be flush with the front face of the seal and may extend not more than 1.0mm beyond this.

4.4 Isolationscrimp / Crimp für Einzeldichtung

A Lage des Isolationsendes

Das Ende der Leiterisolation muss im Übergang zwischen Draht- und Isolationscrimp sichtbar sein. Das Isolationsende darf keinesfalls im Drahtcrimp eingecrimpt sein und darf umgekehrt maximal mit der Vorderkante des Isolationscrimps abschließen.

B Crimpdaten für Isolationscrimp

Die Crimpform, die Crimpbreiten sowie die Isolationsdurchmesser sind in den Tabellen 1, 4 und 7 aufgeführt. Die Crimphöhe wird entweder nach der Biegeprüfung oder nach der Wickelprüfung DIN EN 60 352 Teil 2 eingestellt.

C Lage der Einzeldichtung auf dem Leiter

Das Ende der Leiterisolation muss mindestens bündig mit der Stirnfläche der Einzeldichtung abschließen und darf max. 1,0mm vorstehen.

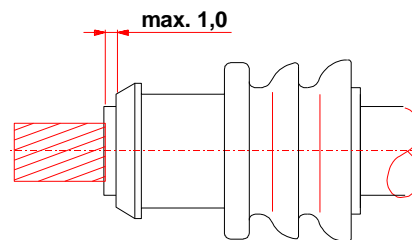

Figure 6 / Abbildung 6

D Crimping Data for Single Wire Seals

The shape and width of the crimp, and the order numbers of the single wire seals are shown in tables 2, 5 and 8.

The crimp height is correctly adjusted if the crimp encloses the seal in the shape of a circle. It is recommended that the crimp height tolerance on the basis of the extension of the collar of the seal by the wire is fully utilized.

E Position of the Single Wire Seal in the Crimp

The collar of the single wire seal must be visible in the window in the base of the crimp. At the most, it may touch the edge of the crimp.

F Visual Inspection

After crimping the single wire seal may have no visible cuts or notches around the diameter of the collar. Only pressure points which cannot cause tearing or splitting of the seal in the long term are permitted.

4.5 Contact Area

The cantilever spring, the locking lances and the contact body may neither be bent nor deformed after crimping.

D Crimpdaten für Einzeldichtungen

Die Crimpform, die Crimpbreiten sowie die Bestellnummern der Einzeldichtungen sind in den Tabellen 2, 5 und 8 aufgeführt.

Die Crimphöhe ist optimal eingestellt, wenn der Crimp die Einzeldichtung möglichst rund umfasst. Es wird empfohlen, die Toleranzen der Crimphöhe entsprechend der Aufweitung des Bundes der Einzeldichtung durch die Leitung voll auszunutzen.

E Lage der Einzeldichtung im Crimp

Der Kragen der Einzeldichtung muss im Fenster des Crimpbodens sichtbar sein. Er darf maximal mit der Crimpflanke abschließen.

F Visuelle Kontrolle

Durch den Crimpvorgang darf die Einzeldichtung im Bereich des Bunddurchmessers weder eingeschnitten noch gekerbt sein. Es sind Druckstellen zulässig, die ein Aufreißen oder Aufplatzen der Dichtung als Langzeiteffekt ausschließen.

4.5 Kontaktbereich

Überfeder, Rastfedern und Kontaktkörper dürfen nach dem Crimpvorgang weder verbogen noch deformiert sein.

4.6 Shape and Position Tolerances

A Contacts with Insulation Crimp

Parallelism

The bottom of the wire crimp and of the insulation crimp respectively must be parallel with the contact body with a tolerance of 0.3mm.

Symmetry

The width of the insulation crimp must be symmetrical with the contact body with a tolerance of 0.3mm.

4.6 Form- und Lagetoleranzen

A Kontakte mit Isolationscrimp

Parallelität

Der Boden des Drahtcrimps bzw. des Isolationscrimps muss, bezogen auf den Boden des Kontaktkörpers, innerhalb einer Parallelitätstoleranz von 0,3mm liegen.

Symmetrie

Der Isolationscrimp muss in der Breite innerhalb einer Symmetrietoleranz von 0,3mm zum Kontaktkörper liegen.

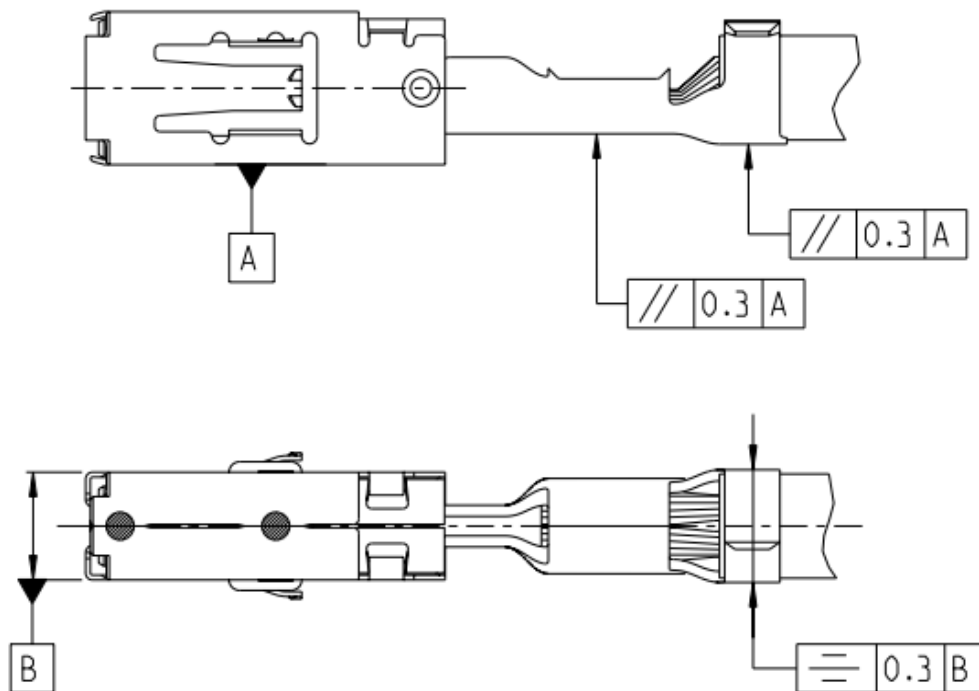

Figure 7 / Abbildung 7

B Contacts for Single Wire Seal

Parallelism

The bottom of the wire crimp and of the insulation crimp respectively must be parallel with the contact body with a tolerance of 0.3mm.

Symmetry

The lateral offset of the crimp for the single wire seal must lie within a tolerance of 0.3mm symmetrical to the contact body.

The single wire seal itself must lie within a vertical symmetry tolerance of 1.0mm.

B Kontakte für Einzeldichtung

Parallelität

Der Boden des Drahtcrimps bzw. des Isolationscrimps muss, bezogen auf den Boden des Kontaktkörpers, innerhalb einer Parallelitätstoleranz von 0,3mm liegen.

Symmetrie

Der seitliche Versatz bzw. die seitliche Abweichung des Crimps für die Einzeldichtung muss innerhalb einer Toleranz von 0,3mm symmetrisch zum Kontaktkörper liegen. Die Einzeldichtung selbst hat seitlich, und nach oben und unten eine Symmetrie von 1,0mm.

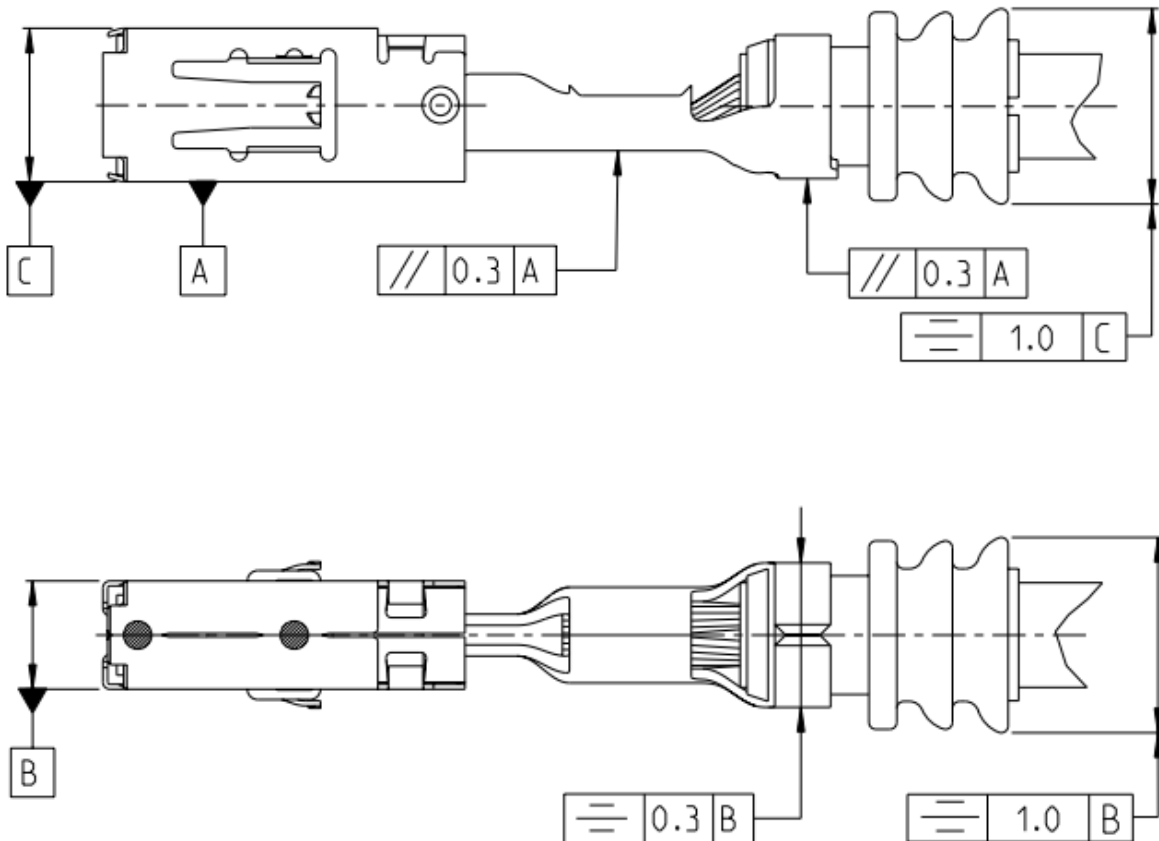

Figure 8 / Abbildung 8

C Contacts without Insulation Crimp

Parallelism

The bottom of the wire crimp must be parallel with the contact body with a tolerance of 0.3mm.

C Kontakte ohne Isolationscrimp

Parallelität

Der Boden des Drahtcrimps muss, bezogen auf den Boden des Kontaktkörpers, innerhalb einer Parallelitätstoleranz von 0,3mm liegen.

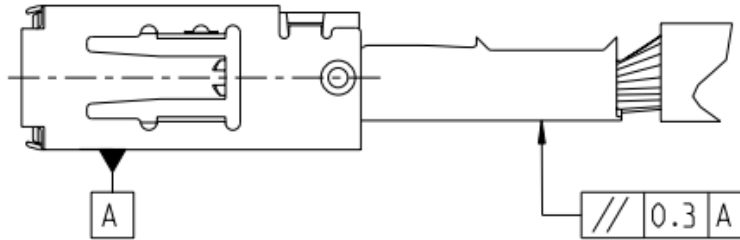

Figure 9 / Abbildung 9

5 CRIMPING DATA

5 CRIMPDATEN

5.1 Crimping Data for ISO Wires

5.1 Crimpdaten für ISO-Leitungen

A Contacts with Insulation Crimp

A Kontakte mit Isolationscrimp

Order No. Bestell-Nr.		Wire Size Range Leiterquerschnitt	Cable Type Leitungs- typ	Insulation Range Isolations- Ø [mm]	Stripped Length Abisolier- länge [mm]	Wire Crimp Drahtcrimp				Insulation Crimp Isolationscrimp		Application Tool Anschlag- werkzeug	Die for Hand Tool Matrize für Handzange		
Strip Form Bandware	Loose Piece Einzel- ware	[mm ²]				Width Breite CB ₁ CB _{2max} [mm]	Height Höhe CH ₁ ±0.05 [mm]		Shape Form	Width Breite CB ₃ [mm]	Shape Form				
							*OLD / ALT	** NEW / NEU							
Locking Lance / mit Rastfeder	968880	968895	0.2	FLR	1.1-1.4	3.6	CB ₁ : 1.57 CB ₂ : 1.72	1.00±0.03	-	F	2.30	+0.20 -0.50	O	x-2151344-x	539721-2
			0.25	FLR				1.02±0.03	-						
			0.35	FLR / FLU				1.08±0.03	-						
			0.5	FLR / FLU				1.14	-						
	2141857	2141858	0.22	FLR / FLU	1.2-1.4	3.6	CB ₁ : 1.57 CB ₂ : 1.72	-	1.06+/-0.03	F	2.30	+0.20 -0.50	O	x-2837932-x	*** 2363592-2
			0.35	FLR / FLU				-	1.04+/-0.03						
			0.5	FLR / FLU				-	1.09+/-0.03						
	968849	968872	0.5	FLR / FLU	1.3-2.1	4.3	CB ₁ : 2.03 CB ₂ : 2.23	1.18	1.15	F	2.54±0.2	OVL	x-2151164-x	539722-2	
			0.75	FLR / FLU				1.27	1.18						
			1.0	FLR / FLU				1.36	1.20						
	968851	968873	1.5	FLR / FLU	1.9-3.0	4.8	CB ₁ : 2.54 CB ₂ : 2.79	1.58	1.47	F	3.56±0.25	OVL	x-2151166-x	539723-2	
			2.5	FLR / FLU				1.88	1.76						
968853	968874	4.0	FLR	2.7-3.7	5.6	CB ₁ : 3.05 CB ₂ : 3.30	2.15	2.10	F	4.06±0.25	OVL	x-2151634-x	539723-2		
Lanceless / ohne Rastfeder	1355876	-	0.2	FLR	1.1-1.4	3.6	CB ₁ : 1.57 CB ₂ : 1.72	1.00±0.03	-	F	2.30	+0.20 -0.50	O	x-2151344-x	539721-2
			0.25	FLR				1.02±0.03	-						
			0.35	FLR / FLU				1.08±0.03	-						
			0.5	FLR / FLU				1.14	-						
	1355833	-	0.5	FLR / FLU	1.3-2.1	4.3	CB ₁ : 2.03 CB ₂ : 2.23	1.18	1.15	F	2.54±0.2	OVL	x-2151164-x	539722-2	
			0.75	FLR / FLU				1.27	1.18						
			1.0	FLR / FLU				1.36	1.20						
	1355877	-	1.5	FLR / FLU	1.9-3.0	4.8	CB ₁ : 2.54 CB ₂ : 2.79	1.58	1.47	F	3.56±0.25	OVL	x-2151166-x	539723-2	
			2.5	FLR / FLU				1.88	1.76						

Table 1 / Tabelle 1

- | | |
|---|--|
| <p>* Previous standard</p> <p>** Preferred standard to meet new requirements of LV214-2 Slow Motion Bending Test</p> <p>*** Basis Hand Tool PN 9-1478240-0 must be used</p> | <p>* bisheriger Standard</p> <p>** bevorzugter Standard, um den neuen Anforderungen der LV214-2 Slow Motion Prüfung zu genügen</p> <p>*** Basis Handzange PN 9-1478240-0 muss verwendet werden</p> |
|---|--|

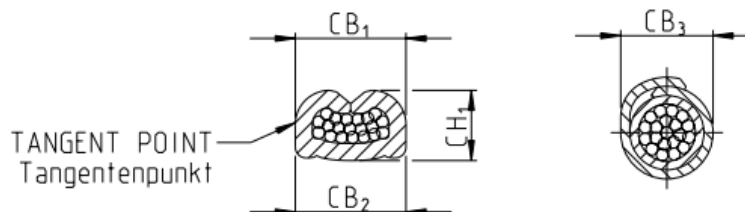

Figure 10 / Abbildung 10

B Contacts for Single Wire Seal

B Kontakte für Einzeldichtung

Order No. Bestell-Nr.		Wire Size Range	Cable Type	Insulation Range	Stripped Length	Wire Crimp Drahtcrimp			Single Wire Seal Crimp Crimp für Einzeldichtung	Application Tool	Die for Hand Tool Matrize für Handzange	Single Wire Seal Einzeldichtung		Dead End Plug Blindstopfen			
Strip Form Bandware	Loose Piece Einzelware	Leiter querschnitt [mm ²]	Leitungs- typ	Isolations- Ø [mm]	Abisolier- länge [mm]	Width Breite CB ₁ CB _{2max} [mm]	Height Höhe CH ₁ ±0.05 [mm]		Shape Form	Width Breite CB ₃ [mm]	Shape Form	Anschlag- werkzeug	Basis Hand Tool Basis Handzange 539635-1	Order No. Bestell-Nr.	Colour Farbe	Order No. Bestell-Nr.	
							*OLD *ALT	** NEW **NEU									
Locking lance mit Rastfeder	968882	968896	0.35	FLR	1.2-1.4	4.0	CB ₁ : 1.57 CB ₂ : 1.72	1.08 ±0.03	-	F	3.94±0.25	O	x-2151559-x	539725-2	828904-1	light blue hellblau	828922-1
	2141859	2141860	0.35	FLR	1.2-1.4	4.0	CB ₁ : 1.78 CB ₂ : 1.95	-	1.04 +/-0.03	F	3.94±0.25	O	x-2836995-x	*** 2365463-2	828904-1	light blue hellblau	828922-1
	968855	968875	0.5	FLR / FLU	1.3-2.1	4.5	CB ₁ : 2.03 CB ₂ : 2.23	1.18	1.15	F	4.06±0.25	O	x-2151227-x	539726-2	828904-1	light blue hellblau	828922-1
			0.75	FLR / FLU				1.27	1.18								
			1.0	FLR / FLU				1.36	1.20								
	968857	968876	1.5	FLU	1.9-2.1	5.0	CB ₁ : 2.54 CB ₂ : 2.79	1.58	1.47	F	4.19 +0.40 -0.25	O	x-2151346-x	539727-2	828904-1 2236402-1	light blue hellblau	828922-1
				FLR	2.2-3.0			1.58	1.47						828905-1	white weiß	
			2.5	FLR / FLU	2.2-3.0			1.88	1.76						2.15	2.10	
	968859	968877	4.0	FLR	3.4-3.7	5.6	CB ₁ : 3.05 CB ₂ : 3.30	-	**** 2.20	F	5.08±0.25	O	x-2151173-x x-2837915-x	539727-2 -	828985-1 -	green grün	828986-1
	Lanceless ohne Rastfeder	2282364	-	1.5	FLU	1.9-2.1	5.0	CB ₁ : 2.54 CB ₂ : 2.79	1.58	1.47	F	4.19 +0.40 -0.25	O	x-2151346-x	539727-2	828904-1	light blue hellblau
FLR					2.2-3.0	1.58			1.47	828905-1						white weiß	
2.5				FLR / FLU	2.2-3.0	1.88			1.76								

Table 2 / Tabelle 2

- | | |
|---|--|
| <p>* Previous standard</p> <p>** Preferred standard to meet new requirements of LV214-2 Slow Motion Bending Test</p> <p>*** Basis Hand Tool PN 9-1478240-0 must be used</p> <p>**** New crimp design (see figure 12) to meet new requirements of VW75174-2 2020-02 Slow Motion Bending Test</p> | <p>* bisheriger Standard</p> <p>** bevorzugter Standard, um den neuen Anforderungen der LV214-2 Slow Motion Prüfung zu genügen</p> <p>*** Basis Handzange PN 9-1478240-0 muss verwendet werden</p> <p>**** Neues Crimpdesign (siehe Abbildung 12) um die Anforderungen der VW75174-2 2020-02 Slow Motion Prüfung zu erfüllen</p> |
|---|--|

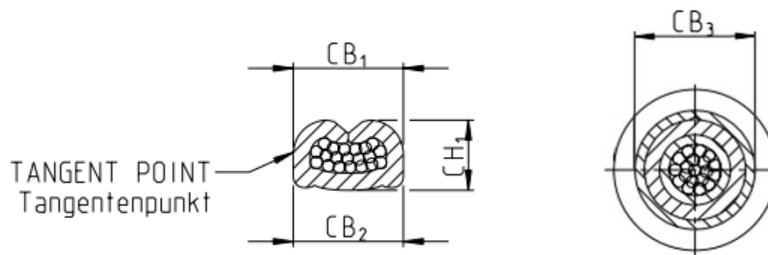

Figure 11 / Abbildung 11

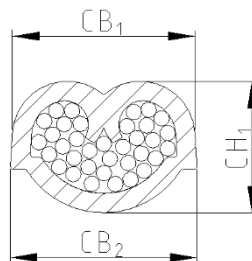

Figure 12 / Abbildung 12

C Contacts without Insulation Crimp

C Kontakte ohne Isolationscrimp

Order No. Bestell-Nr.	Wire Size Range Leiterquerschnitt [mm ²]	Cable Type Leitungstyp	Stripped Length Abisolierlänge [mm]	Wire Crimp Drahtcrimp			Application Tool Anschlagwerkzeug	
				Width Breite CB ₁ CB _{2max} [mm]	Height Höhe CH ₁ ±0.05 [mm]	Shape Form		
Locking Lance mit Rastfeder	2236751	1.5	FLR / FLU	4.8	CB ₁ : 2.54	1.47	F	x-2266444-x
		2.5	FLR / FLU		CB ₂ : 2.79	1.76		
	2236752	4.0	FLR	5.6	CB ₁ : 3.05 CB ₂ : 3.35	2.15	F	x-2266252-x
	2289061	5.0	1)	5.5	CB ₁ : 3.81 CB ₂ : 4.20	2.40	F	2266735-2

Table 3 / Tabelle 3

¹⁾ Validation testing with cable type Delphi M6488

¹⁾ Freigabeprüfung mit Leitungstyp Delphi M6488

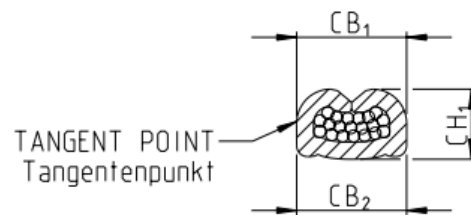

Figure 13 / Abbildung 13

5.2 Crimping Data for JASO Wires

5.2 Crimpdaten für JASO-Leitungen

A Contacts with Insulation Crimp

A Kontakte mit Isolationscrimp

Order No.	Wire Size Range		Cable Type Leitungs- typ	Insulation Range Isolations- Ø [mm]	Stripped Length Abisolier- länge [mm]	Wire Crimp		Shape Form	Insulation Crimp		Application Tool Anschlag- werkzeug	
	Strip Form Bandware	nominal [mm ²]				real [mm ²]	Width Breite CB ₁ CB _{2max} [mm]		Height Höhe CH ₁ ±0.05 [mm]	Width Breite CB ₃ [mm]		Shape Form
Locking Lance / mit Rastfeder	968880	0.3	0.37	CAVS	1.2-1.4	3.6	CB ₁ : 1.57 CB ₂ : 1.72	1.01±0.03	F	2.29 +0.23 -0.12	O	x-2151344-x
			0.38	AESSX-f								
	2141857	0.3	0.37	CAVS	1.2-1.4	3.6	CB ₁ : 1.78 CB ₂ : 1.95	1.05±0.03	F	2.30 +0.20 -0.50	O	x-2836996-x
			0.38	AESSX-f								
	968849	0.5	0.51	AEX-f	1.4-2.1	4.3	CB ₁ : 2.03 CB ₂ : 2.23	1.12±0.03	F	2.54 +0.25 -0.13	OVL	x-2151164-x
				AESSX-f								
				AVS								
				AEX								
		0.75	0.79	AESSX-f								
				AVS								
		0.85	0.85	AVS								
				CAVS								
968851	1.25	1.28	AEX-f	2.2-3.0	4.8	CB ₁ : 2.54 CB ₂ : 2.79	1.46	F	3.56 +0.36 -0.18	OVL	x-2151166-x	
			AESSX-f									
			AVS									
			AEX									
	2.0	1.96	AESSX-f									
			AVS									
	2.09	AVS										
968853	3.0	3.3	AVS	2.7-3.7	5.6	CB ₁ : 3.05 CB ₂ : 3.30	1.92	F	4.06 +0.40 -0.20	OVL	x-2151634-x	
Lanceless / ohne Rastfeder	1355876	0.3	0.37	CAVS	1.2-1.4	3.6	CB ₁ : 1.57 CB ₂ : 1.72	1.01±0.03	F	2.29 +0.23 -0.12	O	x-2151344-x
			0.38	AESSX-f								
	1355833	0.5	0.51	AEX-f	1.4-2.1	4.3	CB ₁ : 2.03 CB ₂ : 2.23	1.12±0.03	F	2.54 +0.25 -0.13	OVL	x-2151164-x
				AESSX-f								
				AVS								
				AEX								
		0.75	0.79	AESSX-f								
				AVS								
		0.85	0.85	AVS								
				CAVS								
	1355877	1.25	1.28	AEX-f	2.2-3.0	4.8	CB ₁ : 2.54 CB ₂ : 2.79	1.46	F	3.56 +0.36 -0.18	OVL	x-2151166-x
				AESSX-f								
AVS												
AEX												
2.0		1.96	AESSX-f									
			AVS									
	2.09	AVS										
1355880	3.0	3.3	AVS	2.7-3.7	5.6	CB ₁ : 3.05 CB ₂ : 3.30	1.92	F	4.06 +0.40 -0.20	OVL	x-2151634-x	

Table 4 / Tabelle 4

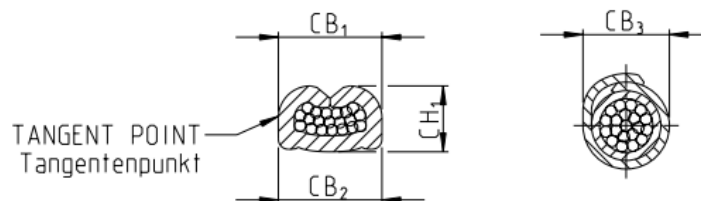

Figure 14 / Abbildung 14

B Contacts for Single Wire Seal

B Kontakte für Einzeldichtung

Order No. Bestell-Nr.	Wire Size Range Leiterquerschnitt		Cable Type Leitungstyp	Insulation Range Isolations- Ø [mm]	Stripped Length Abisolierlänge [mm]	Wire Crimp Drahtcrimp			Single Wire Seal Crimp Crimp für Einzeldichtung		Application Tool Anschlagwerkzeug	Single Wire Seal Einzeldichtung		Dead End Plug Blindstopfen Order No. Bestell-Nr.		
	Strip Form Bandware	nominal [mm ²]				real [mm ²]	Width Breite CB ₁ CB _{2max} [mm]	Height Höhe CH ₁ ±0.05 [mm]	Shape Form	Width Breite CB ₃ [mm]		Shape Form	Order No. Bestell-Nr.		Colour Farbe	
																Order No. Bestell-Nr.
Locking Lance / mit Rastfeder	968882	0.3	0.37	CAVS	1.2-1.4	4.0	CB ₁ : 1.57 CB ₂ : 1.72	1.01±0.03	F	3.94±0.25	O	x-2151559-x	828904-1	light blue hellblau	828922-1	
			0.38	AESSX-f												
	2141859	0.3	0.37	CAVS	1.2-1.4	4.0	CB ₁ : 1.78 CB ₂ : 1.95	1.05±0.03	F	3.94±0.25	O	x-2836995-x	828904-1	light blue hellblau	828922-1	
			0.38	AESSX-f												
	968855	0.5	0.79	0.51	AEX-f	1.4-2.1	4.5	CB ₁ : 2.03 CB ₂ : 2.23	1.12±0.03	F	4.06±0.25	O	x-2151227-x	828904-1	light blue hellblau	828922-1
				0.54	AESSX-f											
				0.56	AVS											
					AEX											
			CAVS													
			0.85	AVS												
			0.88	AVS												
					CAVS				1.26							
968857	1.25	1.28	1.28	AEX-f	2.2-3.0	5.0	CB ₁ : 2.54 CB ₂ : 2.79	1.46	F	4.19 +0.40 -0.25	O	x-2151346-x	828905-1	white weiß	828922-1	
				AESSX-f												
				AVS												
				AEX												
		1.29	CAVS													
		2.0	1.96	AESSX-f				1.66								
		2.09	AVS				1.70									
1719506	3.0	3.3	AVS	3.0-3.8	5.6	CB ₁ : 2.79 CB ₂ : 3.07	1.92	F	5.08-0.50	O	1852290-3	828985-1	green grün	828986-1		
Lanceless / ohne Rastfeder	2282364	1.25	1.28	AEX-f	2.2-3.0	5.0	CB ₁ : 2.54 CB ₂ : 2.79	1.46	F	4.19 +0.40 -0.25	O	x-2151346-x	828905-1	white weiß	828922-1	
													AESSX-f			
				AVS												
				AEX												
		1.29	CAVS													
		2.0	1.96	AESSX-f				1.66								
		2.09	AVS				1.70									
2282365	3.0	3.3	AVS	3.0-3.8	5.6	CB ₁ : 2.79 CB ₂ : 3.07	1.92	F	5.08±0.25	O	1852290-3	828985-1	green grün	828986-1		

Table 5 / Tabelle 5

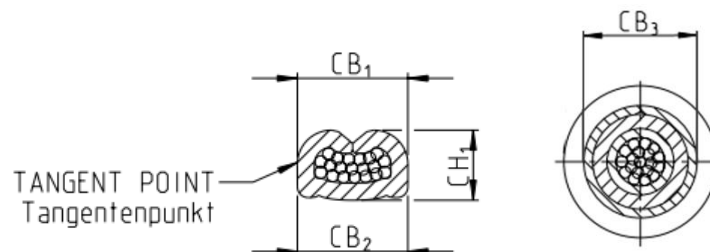

Figure 15 / Abbildung 15

C Contacts without Insulation Crimp

C Kontakte ohne Isolationscrimp

Order No. Bestell-Nr.	Wire Size Range Leiterquerschnitt		Cable Type Leitungstyp	Stripped Length Abisolierlänge [mm]	Wire Crimp Drahtcrimp			Application Tool Anschlagwerkzeug	
	Strip Form Bandware	nominal [mm ²]			real [mm ²]	Width Breite CB ₁ CB _{2max} [mm]	Height Höhe CH ₁ ±0.05 [mm]		Shape Form
Locking Lance mit Rastfeder	2236751	1.25	1.28	AEX-f	4.8	CB ₁ : 2.54 CB ₂ : 2.79	1.46	F	x-2266444-x
				AESSX-f					
			AVS						
		1.29	AEX						
		CAVS							
		2.0	1.96	AESSX-f					
	2.09	AVS							
	2236752	3.0	3.3	AVS	5.6	CB ₁ : 3.05 CB ₂ : 3.30	1.92	F	x-2266252-x

Table 6 / Tabelle 6

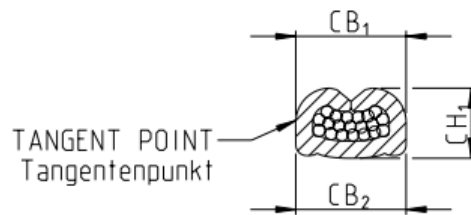

Figure 16 / Abbildung 16

5.3 Crimping Data for AWG Wires

5.3 Crimpdaten für AWG-Leitungen

A Contacts with Insulation Crimp

A Kontakte mit Isolationscrimp

Order No. Bestell-Nr.		Wire Size Range Leiterquerschnitt		Insulation Range Isolations- ∅ [mm]	Stripped Length Abisolier- länge [mm]	Wire Crimp Drahtcrimp			Insulation Crimp Isolationscrimp		Application Tool Anschlag- werkzeug		
Strip Form Bandware	Loose Piece Einzel- ware	nominal [mm ²]	AWG acc. nach SAE J1128			Width Breite CB ₁ CB _{2max} [mm]	Height Höhe CH ₁ ±0.05 [mm]	Shape Form	Width Breite CB ₃ [mm]	Shape Form			
Locking Lance mit Rastfeder	968880	968895	0.25	24	1.2-1.4	3.6	CB ₁ : 1.57	0.92±0.03	F	2.29	+0.23 -0.12	O	x-2151344-x
			0.35	22			CB ₂ : 1.72	0.97					
	2141857	2141858	0.25	24	1.2-1.4	3.6	CB ₁ : 1.57	1.06±0.03	F	2.30	+0.20 -0.50	O	x-2836996-x
			0.35	22			CB ₂ : 1.72	1.02±0.03					
	968849	968872	0.5	20	1.4-2.1	4.3	CB ₁ : 2.03	1.08	F	2.54	+0.25 -0.13	OVL	x-2151164-x
			0.8	18			CB ₂ : 2.23	1.23±0.03					
968851	968873	1.3	16	2.2-3.0	4.8	CB ₁ : 2.54	1.36	F	3.56	+0.36 -0.18	OVL	x-2151166-x	
		2.0	14			CB ₂ : 2.79	1.61						
968853	968874	3.0	12	2.7-3.7	5.6	CB ₁ : 3.05 CB ₂ : 3.30	1.90	F	4.06	+0.40 -0.20	OVL	x-2151634-x	
Lanceless ohne Rastfeder	1355876	-	0.25	24	1.2-1.4	3.6	CB ₁ : 1.57	0.92±0.03	F	2.29	+0.23 -0.12	O	x-2151344-x
			0.35	22			CB ₂ : 1.72	0.97					
	1355833	-	0.5	20	1.4-2.1	4.3	CB ₁ : 2.03	1.08	F	2.54	+0.25 -0.13	OVL	x-2151164-x
			0.8	18			CB ₂ : 2.23	1.23±0.03					
1355877	-	1.3	16	2.2-3.0	4.8	CB ₁ : 2.54	1.36	F	3.56	+0.36 -0.18	OVL	x-2151166-x	
		2.0	14			CB ₂ : 2.79	1.61						
1355880	-	3.0	12	2.7-3.7	5.6	CB ₁ : 3.05 CB ₂ : 3.30	1.90	F	4.06	+0.40 -0.20	OVL	x-2151634-x	

Table 7 / Tabelle 7

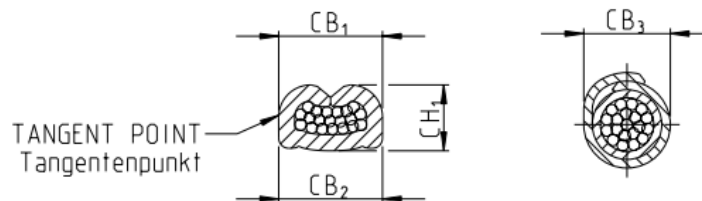

Figure 17 / Abbildung 17

B Contacts for Single Wire Seal

B Kontakte für Einzeldichtung

Order No. Bestell-Nr.	Wire Size Range Leiterquerschnitt		Cable Type Leitungs- typ	Insulation Range Isolations- ϕ [mm]	Stripped Length Abisolier- länge [mm]	Wire Crimp Drahtcrimp			Single Wire Seal Crimp Crimp für Einzeldichtung		Application Tool Anschlag- werkzeug	Single Wire Seal Einzeldichtung		Dead End Plug Blindstopfen		
	Strip Form Bandware	nominal [mm ²]				AWG acc. nach SAE J1128	Width Breite CB ₁ CB _{2max} [mm]	Height Höhe CH ₁ ±0.05 [mm]	Shape Form	Width Breite CB ₃ [mm]		Shape Form	Order No. Bestell-Nr.		Colour Farbe	Order No. Bestell-Nr.
Locking Lance mit Rastfeder	968882	0.2	24	AWG	1.2-1.4	4.0	CB ₁ : 1.57	0.92±0.03	F	3.94±0.25	O	x-2151559-x	828904-1	light blue hellblau	828922-1	
		0.25	22	AWG			CB ₂ : 1.72	0.97								
	968855	0.5	20	AWG	1.4-2.1	4.5	CB ₁ : 2.03	1.08	F	4.06±0.25	O	x-2151227-x	828904-1	light blue hellblau	828922-1	
		0.8	18	AWG			CB ₂ : 2.23	1.17								
	968857	1.3	16	AWG	2.2-3.0	5.0	CB ₁ : 2.54	1.36	F	4.19 +0.40 -0.25	O	x-2151346-x	828905-1	white weiß	828922-1	
		2.0	14	AWG			CB ₂ : 2.79	1.61								
1719506	3.0	12 TXL	AWG	3.0-3.8	5.0	CB ₁ : 2.79 CB ₂ : 3.07	2.00	F	5.08 +0.10 -0.50	O	x-2836789-x	828905-1 282536-1	white weiß	828922-1		
Lanceless ohne Rastfeder	2282364	1.3	16	AWG	2.2-3.0	5.0	CB ₁ : 2.54	1.36	F	4.19 +0.40 -0.25	O	x-2151346-x	828905-1	white weiß	828922-1	
		2.0	14	AWG			CB ₂ : 2.79	1.61								
	2282365	3.0	12 TXL	AWG	3.0-3.8	5.0	CB ₁ : 2.79 CB ₂ : 3.07	2.00	F	5.08±0.25	O	1852290-3	828905-1 282536-1	white weiß	828922-1	

Table 8 / Tabelle 8

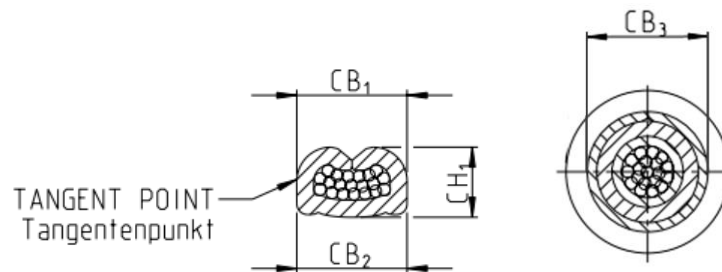

Figure 18 / Abbildung 18

C Contacts without Insulation Crimp

C Kontakte ohne Isolationscrimp

Order No. Bestell-Nr.	Wire Size Range Leiterquerschnitt		Stripped Length Abisolier- länge [mm]	Wire Crimp Drahtcrimp			Application Tool Anschlag- werkzeug	
	Strip Form Bandware	nominal [mm ²]		AWG acc. nach SAE J1128	Width Breite CB ₁ CB _{2max} [mm]	Height Höhe CH ₁ ±0.05 [mm]		Shape Form
Locking Lance mit Rastfeder	2236751	1.3	16	4.8	CB ₁ : 2.54	1.36	F	x-2266444-x
		2.0	14		CB ₂ : 2.79	1.61		
2236752	3.0	12	5.6	CB ₁ : 3.05 CB ₂ : 3.30	1.90	F	x-2266252-x	

Table 9 / Tabelle 9

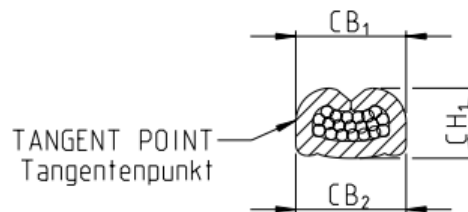

Figure 19 / Abbildung 19

6 AUXILIARY TOOLS

6.1 Extraction Tool

The release of contacts from the housing is made with the extraction tool with order no. 0-1579007-1.

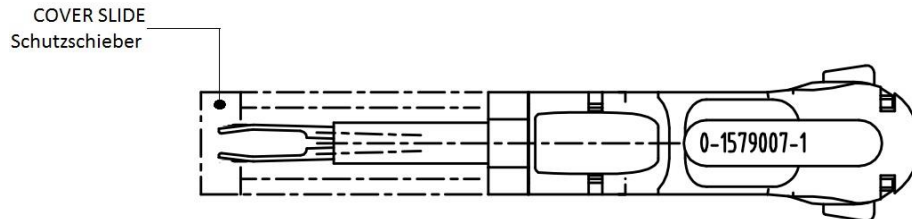

Figure 20 / Abbildung 20

6.2 Assembly Tool

If necessary, assembly tool with order no. 519609-1 can be used to insert the contacts with single wire seal into the housings. The tool must be positioned on the wire so that there is an air gap of approximately 1.5mm between its front edge and the end of the seal. The seal can be pushed into position by slightly opening the tool.

6.3 Dead End Plugs Assembly

Dead end plugs are available for sealing cavities which are not occupied by contacts. The dead end plug is positioned in the cavity as follows:

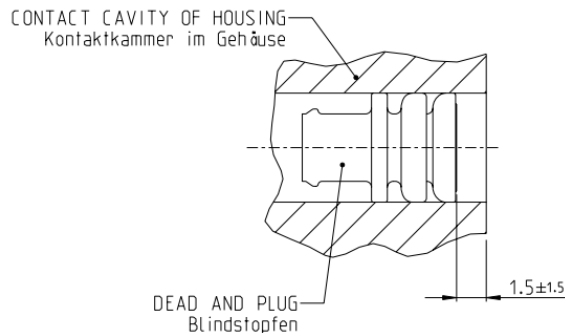

Figure 20 / Abbildung 20

6 HILFSWERKZEUGE

6.1 Ausdrückwerkzeug

Die Entriegelung der Kontakte aus den Gehäusen erfolgt mit dem Ausdrückwerkzeug mit der Bestell-Nr. 0-1579007-1.

6.2 Montagehilfe

Zur Gehäusebestückung von Kontakten mit Einzeldichtung kann im Bedarfsfall eine Montagehilfe, Bestell-Nr. 519609-1, eingesetzt werden. Die Zange wird mit einem Luftspalt von 1,5mm zwischen Vorderkante der Zange und Dichtungsende auf der Leitung angesetzt. Durch leichtes Öffnen der Zange kann die Dichtung in Position gedrückt werden.

6.3 Montage von Blindstopfen

Zur Abdichtung nicht mit Kontakten belegter Kammern stehen Blindstopfen zur Verfügung. Die Position der Blindstopfen in der Kammer ergibt sich wie folgt:

LTR	REVISION RECORD	DWN	APP	DATE
A	<ul style="list-style-type: none"> - section 4.3 E "Burr on Base of Crimp" removed - all existing dash versions of application specification for AMP MCP 2.8 contact system (114-18148-0/-1/-2/-3/-4/-5) combined to one document - FLU wires added to several PNs - description of lanceless versions and version without insulation crimp added 	D. LEIMINGER	S. SPEGEL C. GOEPEL M. JOST	14MAR2016
B	<ul style="list-style-type: none"> - section 4.3 D: range >2.5-4.0mm² increased to >2.5-5.0mm² - section 4.3 E "Burr on Base of Crimp" added (reference to 114-18022) - section 5.1 A: tolerance insulation crimp width for PNs 968880 and 1355876 increased to +0.2/-0.5 - sections 5.1 B, 5.2 B and 5.3 B: tolerance insulation crimp width for PNs 968857 and 2282364 increased to +0.4/-0.25 - section 5.1 C: PN 2289061 added - sections 5.1 C, 5.2 C and 5.3 C: column "Insulation Range" removed - section 5.1 A and B: New crimp heights for 4.0mm² added to meet new requirements of LV214-2 Slow motion bending test - sections: 5.2 A, 5.2 B, 5.3 A and 5.3 B columns "Loose Piece" and "Die For Hand Tool" removed - section 5.3 B: stripped length for PNs 1719506 and 2282365 changed to 5.0 	D. LEIMINGER S. BECK	S. SPEGEL E. GLOMBITZA M. JOST	28JUNE2017
C	<ul style="list-style-type: none"> - section 5.1 A: Crimp optimized PN 2141857 added - section 5.1 B: Crimp optimized PN 2141859 added - section 5.2 B: Insulation width tolerance for PN 1719506 changed to -0.50mm 	S. BECK	S. SPEGEL E. GLOMBITZA M. JOST	13NOV2019
D	<ul style="list-style-type: none"> - section 5.1 A: Crimp height for PN 2141857 0.22mm² added - section 5.2 A: Crimp optimized PN 2141857 added - section 5.2 B: Crimp optimized PN 2141859 added - section 5.3 A: Crimp optimized PN 2141857 added - section 5.1 B: new wire crimp design for PN 968859 added - section 5.3 B: Insulation crimp width tolerance changed for PN 1719506 	S. BECK F. GRIEBEL	S. SPEGEL E. GLOMBITZA D. NAGEL	09AUG2022
D1	<ul style="list-style-type: none"> - Table 2: Seal PN 2236402-1 added - Table 4: insulation crimp width changed to 2.30+0.20/-0.50 to match what is found on page 15 table 1 - Table 7: insulation crimp width changed to 2.30+0.20/-0.50 to match what is found on page 15 table 1 	T. Frank D.J. Gonzalez Figueroa	M. BRUNNER E. GLOMBITZA M. PAJUELO D. NAGEL	07FEB2023