

NUMBER C-177920
METRIC
三角錐 (3rd ANGLE PROJECTION)

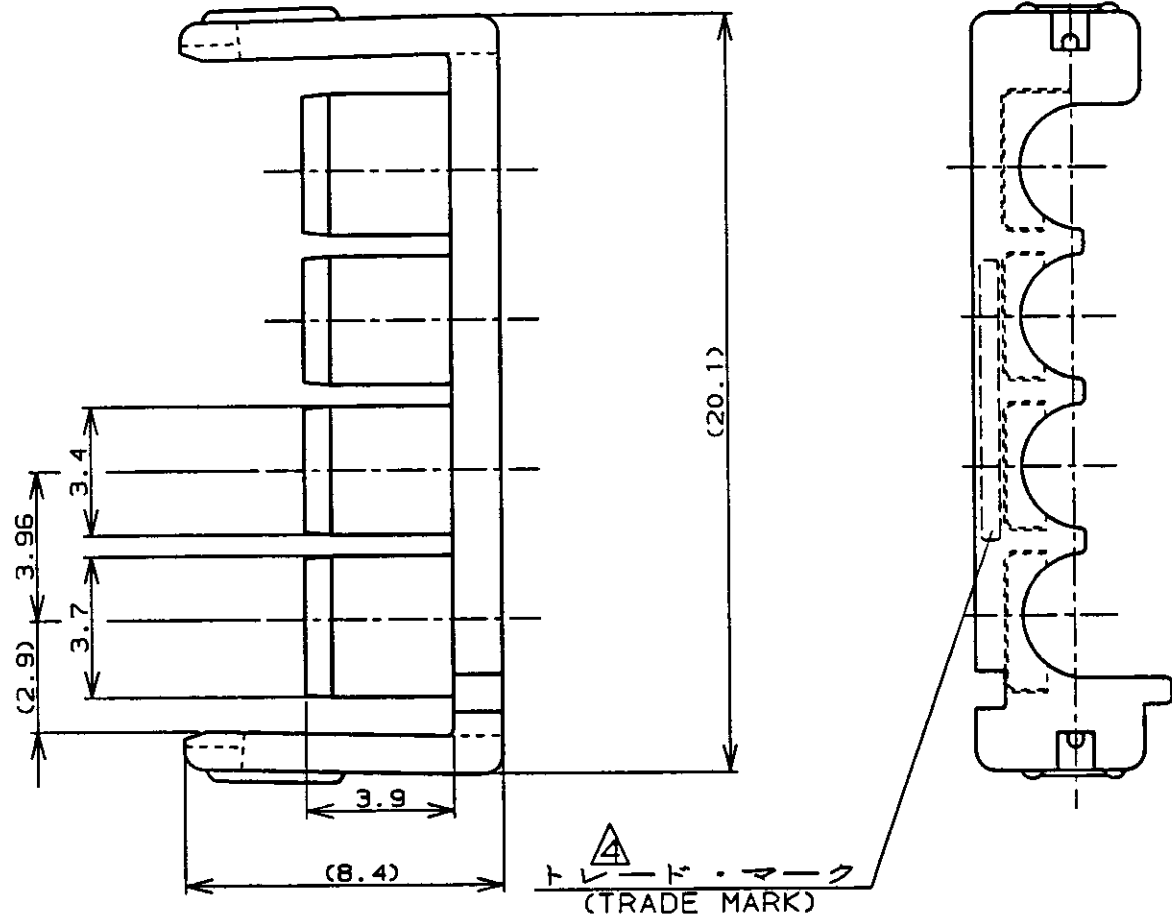
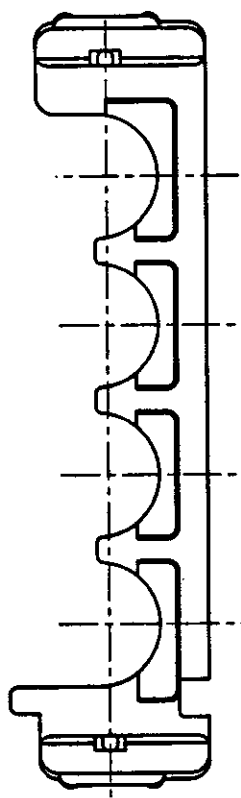

勝特力電材超市-龍山店 886-3-5773766
勝特力電材超市-光復店 886-3-5729570
勝特力電子(上海) 86-21-34970699
勝特力電子(深圳) 86-755-83298787
http://www.100y.com.tw

表 2 (TABLE 2)

トレードマーク (TRADE MARK)	生産場所 (MANUFACTURING PLACES)
-AMP OR AMP	日本 (JAPAN)
-+AMP OR AMP	中国 (CHINA(PRC))



表 1 (TABLE 1)

プラグハウジング (PLUG HOUSING)	8	177902-□	
キャップハウジング (CAP HOUSING)	8	179467-□	パネル (P/M) マウント型
	12	177913-□	宙吊り型 (F/H)
適用製品 (APPLICABLE PRODUCT)	極数 (Pos.)	型番 (P/N)	備考 (REMARK)

自然色 (NATURAL)	4	177920-2	△
自然色 (NATURAL)	4	177920-1	
プレート色調 (PLATE COLOR)	極数 (Pos.)	型番 (P/N)	

- 注:
1. 適用製品規格: 108-5410
 2. 適用製品型番: 表1参照
 3. 取扱説明書: 411-5638
- △表2参照

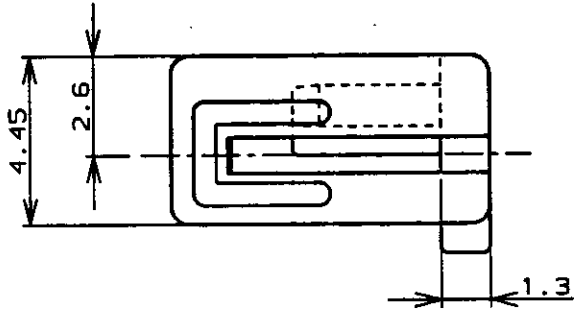
- NOTES,
1. PRODUCT SPEC: 108-5410
 2. APPLICABLE CONN, P/N: SEE TABLE 1
 3. INSTRUCTION SHEET: 411-5638
- △SEE TABLE 2
5. PART 177920-2 COMPLY WITH HOT WIRE REQUIREMENT, PA66, UL 94V-0, HOT WIRE IGNITION (HWI) VERSION ARE MOLDED IN A RESIN THAT COMPLIES WITH TE HOT WIRE IGNITION TEST 109-32026 AND ARE RECOMMENDED FOR USE WITH HWI HOUSING THAT ALSO COMPLY.
- △ Preliminary-not for production

C1	REVISED PER ECR-23-179614	SC	D.Z	03JUL23
C	REVISED PER ECR-20-006535	SC	D.Z	23AUG21
B2	REVISED ECR-14-017020	W.W	D.Z	14/11 '14
B1	REVISED ECR-14-013449	W.W	D.Z	14/9 '14
B	変更 REVISIED FJ00-4805-96 M.Y	M.S	M.S	6/11 '14
A	変更 REVISIED FJ00-2350-95 N.Y	M.S	M.S	4/17 '95
O	作成 PROSOSED FJ00-0791-93 M.S	M.S	M.S	9/8 '93
LTR	変更 (REVISION RECORD)	DR	CHK	DATE

Copyright ©1993年 AMP (Japan), LTD. ALL RIGHTS RESERVED.		Copyright ©1993 AMP (Japan), LTD. ALL RIGHTS RESERVED.	
適合電線断面積 (WIRE RANGE)	被覆外径 (INSULATION DIA.)	電線 (NAME) アンパ パワー ダブルロック コネクタ	
— mm ² (AWG -)	1.3 - 2.8 mmφ	4極 3.96mmピッチ ダブルロック プレート	
MATERIAL: PBT GF (UL94 V-0)	仕上 (FINISH)	AMP POWER DOUBLE LOCK CONN. 3.96mm PITCH DBL LOCK PLATE 4Pos	
DR. M. SUZUKI	DE. M. SUZUKI	一般公差 (GENERAL TOLERANCE)	
CHK. M. SHINDO	APP. Y. KASHIWA	10mm以下: ±0.2	
		10mm以上 30mm以下: ±0.25	
		30mm以上 100mm以下: ±0.3	
		角 度: ±3°	

AMP		東京エー・エム・ピー株式会社 Tokyo, Japan	
LOC	番号 (No.)	C-177920	
B	J	尺度 (SCALE)	REV. C1
		SHEET 1 OF 1	

PRINT DIST
単位: ㎜ DIMENSIONS IN MM. DO NOT SCALE PRINT

AMP-J
REV. 10/'83

(CUSTOMER DRAWING) 参考 面

**NOTE**

All numerical values are in metric units [with U.S. customary units in brackets]. Dimensions are in millimeters [and inches]. Unless otherwise specified, dimensions have a tolerance of ± 0.13 [± 0.005] and angles have a tolerance of $\pm 2^\circ$. Figures and illustrations are for identification only and are not drawn to scale.

1. INTRODUCTION

This specification covers the requirements for application of the Power Double Lock connector system.

2. REFERENCE MATERIAL**2.1. Revision Summary**

Revisions to this application specification include:

- Add part no.

2.2. Customer Assistance

Reference Product Base Part Number 177914, 177915, 177916, 177917, 2232901, 2232902, 2238096, 2323832, 2323853 and Product Code 2166 are representative of the Power Double Lock connector system. Use of these numbers will identify the product line and help you to obtain product and tooling information when visiting www.te.com or calling the number at the bottom of page 1.

2.3. Drawings

Customer drawings for product part numbers are available from www.te.com. Information contained in the customer drawing takes priority.

2.4. Specifications

Product Specification [108-5410](#) provides product performance and test results.

2.5. Instructional Material

Instruction material that pertains to this product is:

- 408-10389 Ocean Side-Feed Applicator 2151072, 2151074, 2836245, 2836138, 2836961, 2836487, 2837190, 2837191
- 411-5667 Straight Action Hand Tool 934653-1, 934654-1
- 411-5638 Instruction Sheet – Power Double Lock Connector System
- 1583010 CERTI-CRIMP* II Data Sheet 91567-1, 91567-3, 91569-1, 91569-3

3. REQUIREMENTS**3.1. Safety**

Do not stack product shipping containers so high that the containers buckle or deform.

3.2. Storage**A. Ultraviolet Light**

Prolonged exposure to ultraviolet light may deteriorate the chemical composition used in the product material.

B. Shelf Life

The product should remain in the shipping containers until ready for use to prevent deformation to components. The product should be used on a first in, first out basis to avoid storage contamination that could adversely affect performance.

C. Chemical Exposure

Do not store product near any chemical listed below as they may cause stress corrosion cracking in the material.

Alkalies	Ammonia	Citrates	Phosphates	Citrates	Sulfur Compounds
Amines	Carbonates	Nitrites	Sulfur Nitrites		Tartrates

3.3. Wire Selection and Preparation

The contacts accept 1 stranded copper wire sizes 0.14 to 1.38 mm² [26 AWG to 16 AWG] with an insulation diameter range of 1.3 to 3.1.

Each wire must be stripped to the dimension given in Figure 1.



CAUTION

Care must be taken not to nick, scrape, or cut any part of the wire during the stripping operation.

Note: Not to Scale

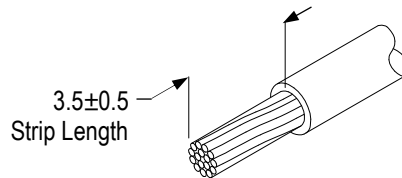

Figure 1

3.4. Contact Crimp

A. Cutoff Tab

The cutoff tab is the remaining portion of the carrier strip after the contact is cut from the strip. The cutoff tab must not exceed the dimension given in Figure 2.

B. Wire Barrel Crimp

The crimp applied to the wire barrel portion of the contact is the most compressed area and is most critical in ensuring optimum electrical and mechanical performance of the crimped contact. The crimp must be centered on the closed wire barrel. The crimp must result in an “F” crimp where the wire barrel forms a closed seam with no evidence of loose wire strands or wire strands visible in the seam. The crimp height and width must be within the dimension provided in Figure 2.

C. Wire Barrel Flash

Wire barrel flash is the formation that may appear on both sides of the wire barrel as a result of the crimping process. It must not exceed the dimensions given in Figure 2.

D. Twist and Roll

There should be no twist or roll of the wire barrel or mating portion of the crimped contact that would cause overstress or impair usage. It must not exceed the limits given in Figure 2.

E. Bend Allowance

The bend allowance between the wire barrel and the cable is acceptable within the limits given in Figure 2.

F. Wire End Extrusion Length and Height

The wire conductor ends must extend beyond the end of the wire barrel within the dimensions given in Figure 2. The wire end extrusion height may not exceed the limits given in Figure 2.

G. Bellmouths

The front bellmouth and rear bellmouth shall conform to the dimensions given in Figure 2.

H. Insulation Barrel Crimp

The crimp applied to the insulation barrel of the contact must result in either an “F” crimp where the insulation barrel forms a closed seam with no evidence of wire insulation in the seam or an overlap crimp where the tips of the insulation barrel wraps overlap each other and wrap firmly around the wire insulation without cutting into the wire insulation. The crimp height and width must be within the dimensions provided in Figure 2.

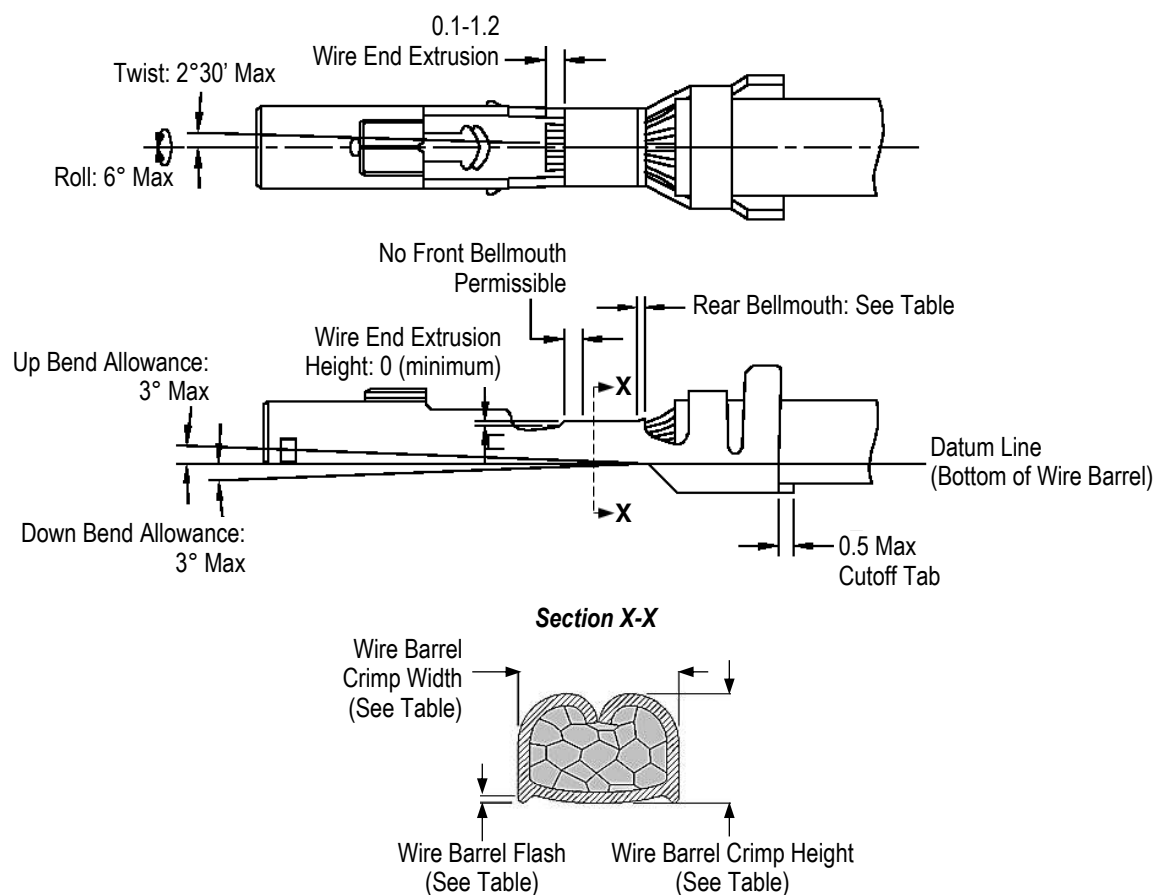

Figure 2 (continued)

Part Number	Wire Size (mm ² [AWG])	Insulation Diameter Range	Wire Crimp		Insulation Barrel Width	Crimp Tensile Strength [N]	Wire Barrel Flash (maximum)	Rear Bellmouth Length
			Width ²⁾	Height				
177914-x 177916-x 2369502-x	0.14 [26]	1.3-2.0	1.4+0.14/0 ("F")	0.80±0.05	2.75 ("F")	19.6	0.3	0.1-0.5
	0.22 [24]			0.85±0.05		29.4		
	0.34 [22]			0.89±0.05		49.0		
	0.51 [20]	2.2		0.98±0.05		58.8		
177914-x 177916-x 2369502-x	0.14 [26]	1.52-2.0	1.4+0.14/0 ("F")	0.80±0.05	2.75 ("OV")	19.6	0.3	0.1-0.5
	0.22 [24]			0.85±0.05		29.4		
	0.34 [22]			0.89±0.05		49.0		
	0.22 [24] *2	1.4max.*2		0.91±0.05		29.4(for each)		
177915-x 177917-x 2369503-x	0.51 [20]	1.8-3.1	2.03+0.2/0 ("F")	1.05±0.05	3.3 ("F")	58.8	0.3	0.1-0.5
	0.89 [18]			1.15±0.05		68.6		
	1.27 [16]			1.29±0.05		78.5		
177915-x 177917-x 2369503-x	0.51 [20]	2.15-3.1	2.03+0.2/0 ("F")	1.05±0.05	3.3 ("OV")	58.8	0.3	0.1-0.5
	0.89 [18]			1.15±0.05		68.6		
	1.27 [16]			1.29±0.05		78.5		
179592-x 179594-x	0.14 [26]	1.3-2.0	1.4+0.14/0 ("F")	0.69-0.83	2.75 ("F")	19.6	0.3	0.1-0.5
	0.22 [24]			0.69-0.88		29.4		
	0.34 [22]			0.77-0.94		49.0		
179593-x 179595-x	0.51 [20]	1.8-3.1 ¹⁾	2.03+0.2/0 ("F")	0.97-1.09	3.3 ("F")	58.8	0.3	0.1-0.5
	0.89 [18]			0.97-1.20		68.6		
	1.27 [16]			1.223-1.42		78.5		
2232902-x x-2232902-x 2369501-x	0.14 [26]	1.3-2.0	1.4+0.14/0 ("F")	0.80±0.05	2.75 ("OV")	19.6	0.13	0.75-1.00
	0.22 [24]			0.85±0.05		29.4		
	0.34 [22]			0.89±0.05		49.0		
2232901-x x-2232901-x 2369500-x	0.51 [20]	1.8-3.1	2.03+0.2/0 ("F")	1.05±0.05	3.3 ("OV")	58.8	0.13	0.75-1.00
	0.89 [18]			1.15±0.05		68.6		
	1.27 [16]			1.29±0.05		78.5		
2238096-x	0.51 [20]	1.8-3.1	1.78+0.17/0 ("F")	0.94±0.05	3.3 ("F")	58.8	0.3	0.1-0.5
2323853-x	0.51 [20]	1.75-2.5	1.78+0.17/0 ("F")	0.94±0.03	3.3 ("OV")	58.8	0.3	0.1-0.5
	0.81 [18]			1.03±0.05		68.6		
2323832-x x-2323832-x	0.51 [20]	1.75-2.5	1.78+0.17/0 ("F")	1.00±0.03	3.3 ("OV")	58.8	0.13	0.75-1.00
	0.81 [18]			1.08±0.05		68.6		

¹⁾ When crimping P/N 179593-1 and 179595-1 with a hand tool onto wire with an insulation diameter between 1.8 and 2.0, the insulation barrel end may have a loose hold on the insulation.

²⁾ Nominal crimp widths are not the product width after crimping but given by the width of crimper slot for reference. Tolerances of crimp width are the measurable crimp width after crimping.

Figure 2 (end)

I. Contact Stabilizer

The contact stabilizer should be deformed, the width of the stabilizer must be within the limits specified in Figure 3.

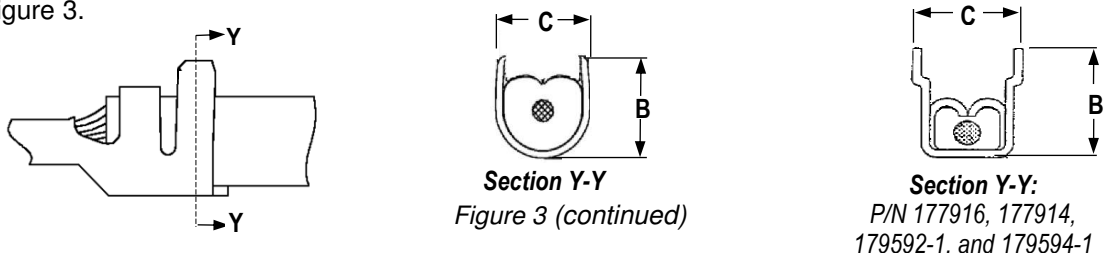

Part Number	Dimension B	Dimension C
177916-x, 2369502-x	3.7 (REF)	3.15+/-0.25
177914-x		
177917-x, 2369503-x		
177915-x		
179592-x		
179594-x		
179593-x		
179595-x		
2323853-x	3.4 (REF)	
2232902-x, x-2232902-x, 2369501-x		
2232901-x, x-2232901-x, 2369500-x		
2238096-x		
2323832-x, x-2323832-x		

Figure 3 (end)

J. Contact Length

The contact length measured on the upper portion of the contact at the back of the contact stabilizer (not including the carrier strip cutoff tab) must be within the dimensions given in Figure 4.

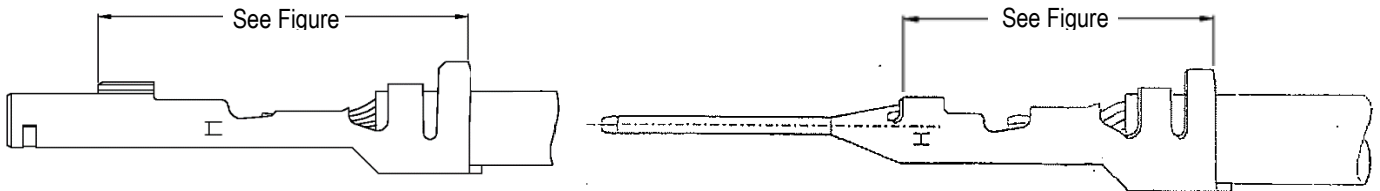

Part Number	Contact Length
177916-x, 2369502-x (Tab)	10.3+0.4/-0.3
177917-x, 2369503-x (Tab)	
179594-x (Tab)	
179595-x (Tab)	
2323853-x(Tab)	
177914-x (Receptacle)	11.6+0.4/-0.3

177915-x (Receptacle)	
179592-x (Receptacle)	
179593-x (Receptacle)	
2238096-x (Receptacle)	
2232902-x, x-2232902-x, 2369501-x (Receptacle)	11.35+0.4/-0.3
2232901-x, x-2232902-x, 2369500-x (Receptacle)	
2323832-x, x-2323832-x (Receptacle)	

Figure 4

3.5. Strain Relief and Wire Dress

Wires can be bundled together and supported using cable ties or electrical tap. The wires must remain perpendicular to the housing and avoid an excessively sharp bend radius. The wire bundle must be at least 76.2 mm [3.0 inch] from the back of the housing before bending in any direction. Do not bend unsupported wires as this may cause strain on the contacts. See Figure 5.

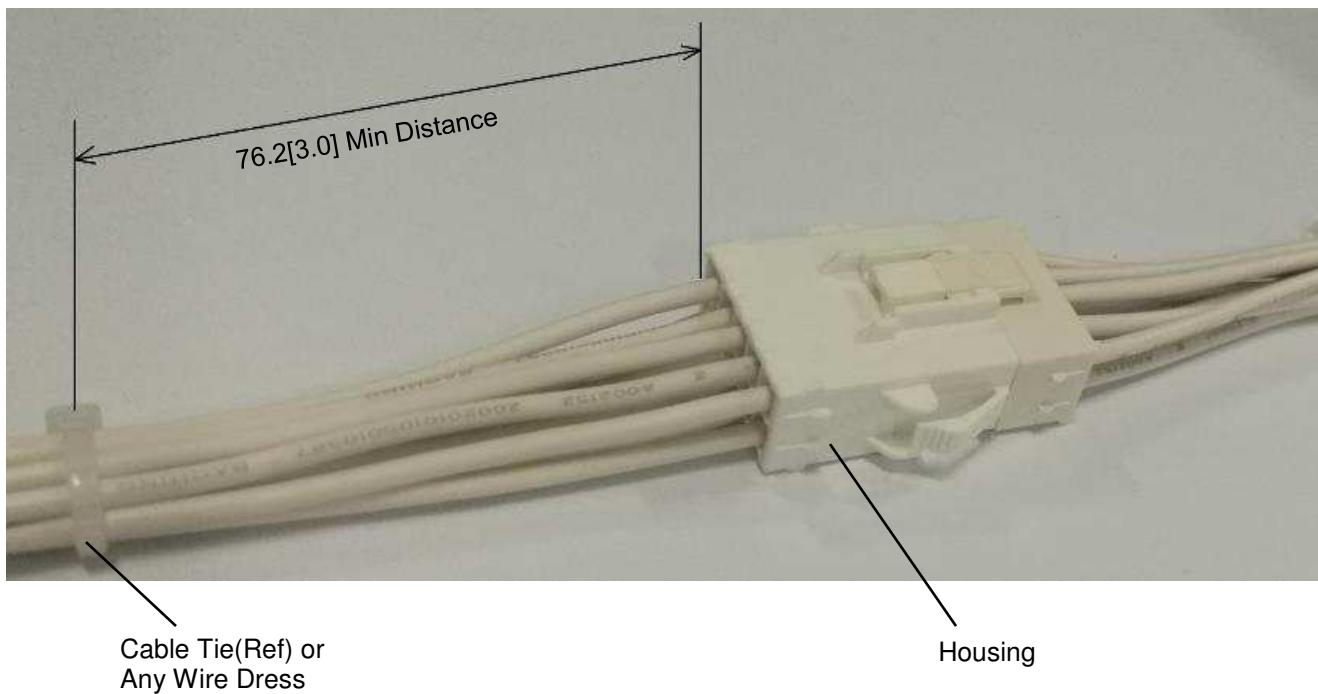

Figure 5

4. QUALIFICATION

4.1. Underwriters Laboratories Inc. (UL)

The Power Double Lock connector system is recognized by Underwriters Laboratories Inc. (UL) in File E28476.

4.2. Canadian Standards Association (CSA)

The Power Double Lock connector system is certified by Canadian Standards Association (CSA) in File LR7189.

4.3. Technischen Überwachungs Vereine (TUV)

A portion of the Power Double Lock connector system is approved by TUV in File No. 40046979. Please refer to the certificate to find a listing of the TUV approved Power Double Lock connector system part numbers.

5. TOOLING

5.1. Applicator

The applicators are designed to crimp tape-mounted contacts onto pre-stripped wire. The applicators accept interchangeable die assemblies and must be installed onto a power unit. See Figure 6.

Part Number	Applicator	Hand Tool
177914-x 177916-x 2369502-x ("F" Insulation Crimp)	2151072	—
177915-x 177917-x 2369503-x ("F" Insulation Crimp)	2151074	—
177914-x 177916-x 2369502-x ("OV" Insulation Crimp)	2836138	—
177915-x 177917-x 2369503-x ("OV" Insulation Crimp)	2836961	—
179592-x 179594-x	—	934653-1 91567-1 91567-3
179593-x 179595-x	—	934654-1 91567-3
2232902-x x-2232902-x 2369501-x	2836138	—
2232901-x x-2232901-x 2369500-x	2836245	—
2238096-x	2836487	—
2323832-x x-2323832-x	2837191	—
2323853-x	2837190	—

Figure 6