

LOC J	DIST —	REVISIONS 変更			DATE	DWN	APVD
		P	LTR	DESCRIPTION			
		C		REVISED PER ECR-15-011723	08AUG15	Y.O	E.T

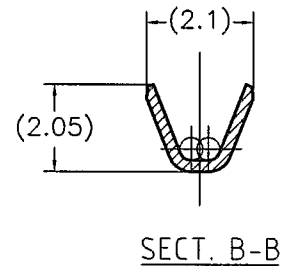

勝特力電材超市-龍山店 886-3-5773766
 勝特力電材超市-光復店 886-3-5729570
 勝特力电子(上海) 86-21-34970699
 勝特力电子(深圳) 86-755-83298787
<http://www.100y.com.tw>

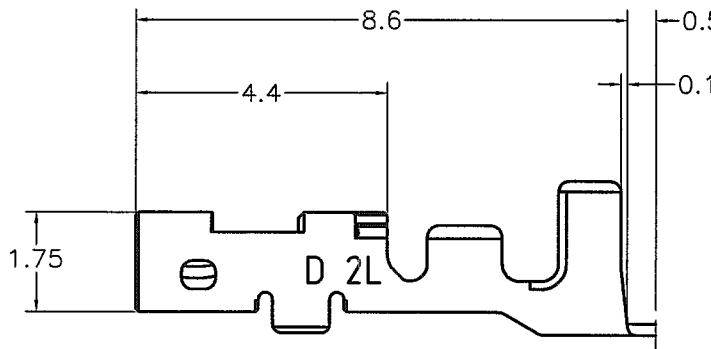
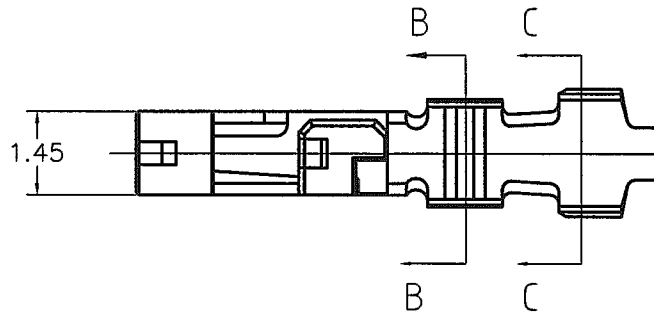
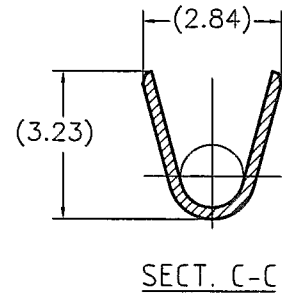
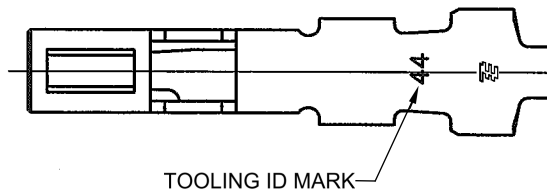

NOTE

1. GENERAL TOLERANCE : $\pm 0.3, \pm 3^\circ$
2. Application REC-HSG is applied to the product of 2.5mm PITCH or more of DYNAMIC D1000SERIES. 2.0mm PITCH cannot be used

RELEASED FOR PUBLICATION

ALL RIGHTS RESERVED.

BY TYCO ELECTRONICS CORPORATION.

THIS DRAWING IS UNPUBLISHED.

© COPYRIGHT

1871745-1
PART No.

DIMENSIONS: 单位: 毫米 mm	DWN T.KUDO 1JUL2005	MATERIAL 材料 PRE-TIN COPPER ALLOY	FINISH 仕上			
	CHK D.MITSUGI 1JUL2005					
	APVD D.MITSUGI 1JUL2005					
	TOLERANCES UNLESS OTHERWISE SPECIFIED: 一般公差	PRODUCT SPEC 製品規格 108-78298	NAME 名称 DYNAMIC D1000 SERIES REC CONTACT (2L TYPE) TIN PLATE (L/P)			
0 PLC ± 1 PLC ± 2 PLC ± 3 PLC ± 4 PLC ± ANGLES ±	APPLICATION SPEC 取付適用規格 114-5377	SIZE A4	CAGE CODE 00779	DRAWING NO 番号 C-1871745	RESTRICTED TO —	
	WEIGHT —	CUSTOMER DRAWING		SCALE 尺度 8:1	SHEET 1 OF 1	REV C

Crimping requirements for DYNAMIC 1000 Series contacts

1. SCOPE

This Application specification covers the crimping requirements for DYNAMIC 1000 Series contacts

2. APPLICABLE PRODUCT PART NUMBER

See Fig.1.

Contact Type	Size	Contact Part number L/P: Loose Piece	Plating Finish	Wire Size (AWG# REF) [mm ²]	Insulation Diameter [mm]
Receptacle Contact	S	1827569-2/ *- 2367817-1 [b] : Reel	Gold Plating	0.05~0.10 (#30~#28)	φ 0.60~ φ 1.20
		1827586-2/ *-2367818-1 [b] : L/P			
	M	1827570-2/ *-2367817-2 [b] : Reel	Gold Plating	0.08~0.37 (#28~#22)	φ 1.08~ φ 1.60
		1827587-2/ *-2367818-2 [b] : L/P			
		1939991-2 : Reel	Gold 0.76Plating		
		1939992-2 : L/P			
		1871303-1 : Reel			
	1871743-1 : L/P				
	L [a]	1827571-2 : Reel	Gold Plating	0.08~0.37 (#28~#22)	φ 1.08~ φ 1.90
		1827588-2 : L/P	Tin Plating		
		1871304-1 : Reel			
	2L [a]	1871744-1 : L/P			
		1827572-2 : Reel	Gold Plating	0.34~0.87 (#22~#18)	φ 1.40~ φ 2.20
		1827589-2 : L/P	Tin Plating		
		1871731-1 : Reel			
	1871745-1 : L/P				
	S	1903111-2/ *-2367819-1 [b] : Reel	Gold Plating	0.05~0.10 (#30~#28)	φ 0.60~ φ 1.20
		1903115-2/ *-2367820-1 [b] : L/P			
	M	1903112-2/ *-2367819-2 [b] : Reel	Gold Plating	0.08~0.37 (#28~#22)	φ 1.08~ φ 1.60
		1903116-2/ *-2367820-2 [b] : L/P			
		1903120-1 : Reel	Tin Plating		
		1903124-1 : L/P			
	L [a]	1903113-2 : Reel	Gold Plating	0.08~0.37 (#28~#22)	φ 1.08~ φ 1.90
		1903117-2 : L/P	Tin Plating		
		1903121-1 : Reel			
		1903125-1 : L/P			
	2L [a]	1903114-2 : Reel	Gold Plating	0.34~0.87 (#22~#18)	φ 1.40~ φ 2.20
		1903118-2 : L/P	Tin Plating		
		1903122-1 : Reel			
		1903126-1 : L/P			

Fig.1

[a]. L and 2L size are not applicable for D1100 (2.0mm Pitch) housings.

[b]. D1000 Slim Contact. It is applicable for D1000 slim housings.

3. Crimping REQUIREMENTS

See Fig.2 and Fig.3

NO.	Check Item	Specified Requirements	NO.	Check Item	Specified Requirements
①	Wire Stripping Length	2mm±0.3	⑥	Twisting	3° Max
②	Cut-Off Tab Length	0.25mm Max	⑦	Rolling	5° Max
③	Rear Bell mouth Length	0.1~0.3mm	⑧	Wire-End Protrusion Length	0.1~0.65mm
④	Bend-Up	3° Max	⑨ 【c】	Insulation Barrel Width	See Fig.4, 5
⑤	Bend-Down	3° Max	⑩ 【c】	Insulation Barrel Height	See Fig.4, 5

【c】. Insulation barrel crimping dimension ⑨ and ⑩ should be controlled under Fig.5 and Fig.6 not to interfere housings.

Fig 2

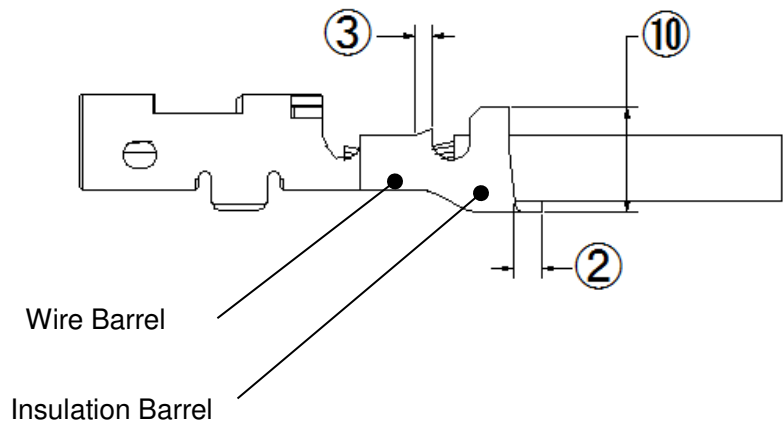
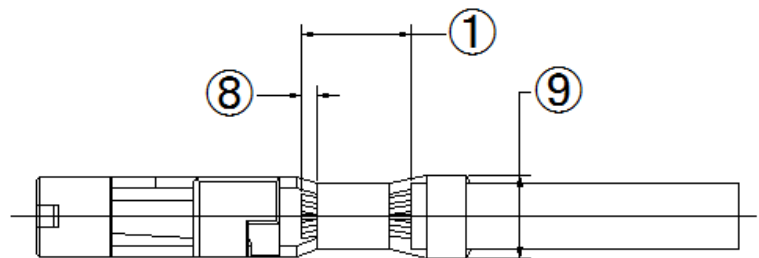

Fig 3

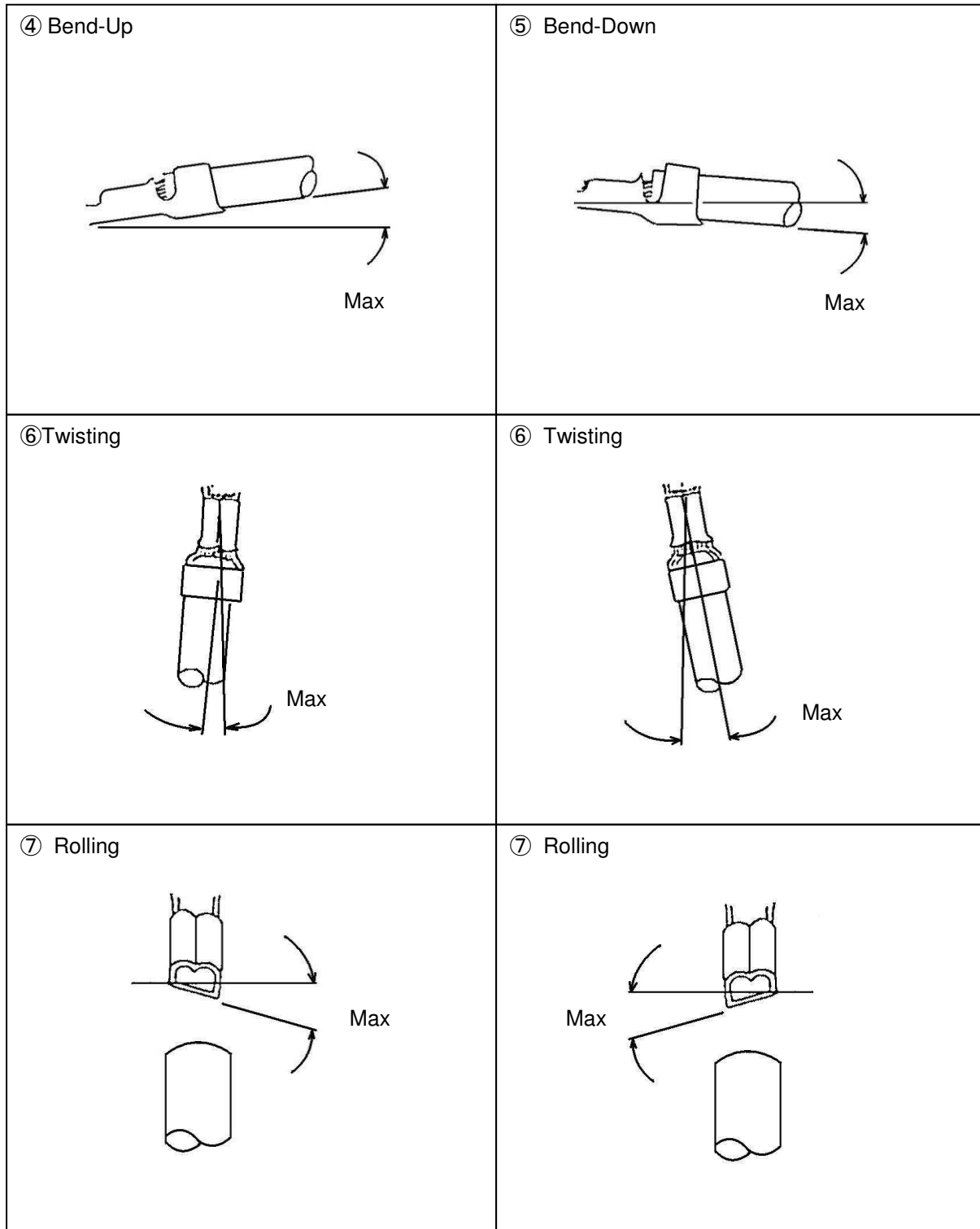

Fig.4

4. CRIMPING DATA

4.1 Applicator

See Fig.5

Reel Contact Part No	Applicator Number	Wire Size		Insulation Stripping Length [mm]	Wire Crimp		Insulation		Finished Insulation Diameter [mm]	Crimp Tensile Strength [Kg MIN]	
		No. of Conductor [e]	Cross Section [mm ²] (AWG) [f]		Width [mm]	Crimp Height [mm]	⑨ Barrel Width [mm]	⑩ Crimp Height [mm]			
D1000 contact [g]											
S	1827569-2 1903111-2	2151110-1	1	0.05~ 0.06(#30)	2.0±0.3	0.90 (REF)	0.54±0.03	1.5MAX " F "	1.4~ 1.8MAX	φ0.60~ φ1.20	0.5
			1	0.08~ 0.10(#28)			0.57±0.03				1.0
M	1827570-2 1871303-1 1903112-2 1903120-1 1939991-2	2151082-1	1	0.08~ 0.10(#28)	2.0±0.3	1.16 (REF)	0.64±0.03	1.5MAX " F "	1.6~ 2.2MAX	φ1.08~ φ1.60	1.0
			1	0.12~ 0.15(#26)			0.67±0.03				2.0
			1	0.21~ 0.23(#24)			0.73±0.03				3.0
			1	0.34~ 0.37(#22)			0.80±0.03				4.5
L [d]	1827571-2 1871304-1 1903113-2 1903121-1	2151111-1	1	0.08 0.10(#28)	2.0±0.3	1.16 (REF)	0.64±0.03	2.1MAX " F "	1.6~ 2.4MAX	φ1.08~ φ1.90	1.0
			1	0.12~ 0.15(#26)			0.67±0.03				2.0
			1	0.21~ 0.23(#24)			0.73±0.03				3.0
			1	0.34~ 0.37(#22)			0.80±0.03				4.5
2L [d]	1827572-2 1871731-1 1903114-2 1903122-1	2151083-1	1	0.34~ 0.37(#22)	2.0±0.3	1.40 (REF)	0.85±0.03	2.1MAX " F "	2.0~ 2.4MAX	φ1.40~ φ2.20	4.5
			1	0.51~ 0.53(#20)			1.00±0.03				6.5
			1	0.85~ 0.87(#18)			1.15±0.03				6.5
D1000 Slim contact [g]											
S	*-2367817-1 *-2367819-1	2151110-1	1	0.05~ 0.06(#30)	2.0±0.3	0.90 (REF)	0.49-0.55	1.5MAX " F "	1.4~ 1.8MAX	φ0.60~ φ1.20	0.5
			1	0.08~ 0.10(#28)			0.52-0.57				1.0
M	*-2367817-2 *-2367819-2	2151082-1	1	0.08~ 0.10(#28)	2.0±0.3	1.16 (REF)	0.64±0.03	1.5MAX " F "	1.6~ 2.2MAX	φ1.08~ φ1.60	1.0
			1	0.12~ 0.15(#26)			0.67±0.03				2.0
			1	0.21~ 0.23(#24)			0.73±0.03				3.0
			1	0.34~ 0.37(#22)			0.80±0.03				4.5

See Fig.5

[d]. L and 2L size are not applicable for D1100 (2.0mm Pitch) housings

[e]. The contacts are not applicable for crimping multi wires. The strand diameter should be over ϕ 0.1mm.

[f]. Solid wire is not applied.

[g]. After crimped, check that the crimped sample can be inserted into the housing.

2 Hand Tool

See Fig.6

Loose Piece Contact Part No	Hand Tool Number	Wire Size		Insulation Stripping Length [mm]	Wire Crimp		Insulation		Finished Insulation Diameter [mm]	Crimp Tensile Strength [Kg MIN]			
		No. of Conductor [i]	Cross Section [mm ²] (AWG) [j]		Width [mm]	Crimp Height [mm]	⑨ Barrel Width [mm]	⑩ Crimp Height [mm]					
D1000 contact [i]													
S	1827586-2 1903115-2	2119144-1	1	0.05~ 0.06(#30)	2.0±0.3	0.90 (REF)	0.49~0.59	1.5MAX " F "	1.3(REF)	φ0.60~ φ1.00	0.5		
			1	0.08~ 0.10(#28)			0.52~0.62		1.5(REF)			φ0.80~ φ1.20	1.0
M	1827587-2 1871743-1 1903116-2 1903124-1 1939992-2	2119141-1	1	0.08~ 0.10(#28)	2.0±0.3	1.16 (REF)	0.59~0.69	1.5MAX " F "	1.95(REF)	φ1.08~ φ1.40	1.0		
			1	0.12~ 0.15(#26)			0.59~0.69					2.0	
			1	0.21~ 0.23(#24)			0.69~0.79				2.1(REF)		φ1.20~ φ1.60
			1	0.34~ 0.37(#22)			0.69~0.79				4.5		
L [h]	1827588-2 1871744-1 1903117-2 1903125-1	2119143-1	1	0.08~ 0.10(#28)	2.0±0.3	1.16 (REF)	0.59~0.69	2.1MAX " F "	2.05(REF)	φ1.08~ φ1.40	1.0		
			1	0.12~ 0.15(#26)			0.59~0.69					2.0	
			1	0.21~ 0.23(#24)			0.69~0.79		2.2(REF)	φ1.20~ φ1.90	3.0		
			1	0.34~ 0.37(#22)			0.69~0.79		4.5				
2L [h]	1827589-2 1871745-1 1903118-2 1903126-1	2119142-1	1	0.34~ 0.37(#22)	2.0±0.3	1.40 (REF)	0.80~0.90	2.1MAX " F "	2.1(REF)	φ1.40~ φ2.00	4.5		
			1	0.51~ 0.53(#20)			0.80~0.90					6.5	
			1	0.85~ 0.87(#18)			1.10~1.20		2.4(REF)	φ1.80~ φ2.20	6.5		
D1000 Slim contact [i]													
S	*-2367818-1 *-2367820-1	2381707-2 [m]	1	0.05~ 0.06(#30)	2.0±0.3	0.90 (REF)	0.49-0.55	1.5MAX " F "	1.3(REF)	φ0.60~ φ1.00	0.5		
		2381707-2 [n]	1	0.08~ 0.10(#28)			0.52-0.57		1.5(REF)			φ0.80~ φ1.20	1.0
M	*-2367818-2 *-2367820-2	2381748-1 (2119141-1 with 2381710-1) [k]	1	0.08~ 0.10(#28)	2.0±0.3	1.16 (REF)	0.59~0.69	1.5MAX " F "	1.95(REF)	φ1.08~ φ1.40	1.0		
			1	0.12~ 0.15(#26)			0.59~0.69					2.0	
			1	0.21~ 0.23(#24)			0.69~0.79				2.1(REF)		φ1.20~ φ1.60
			1	0.34~ 0.37(#22)			0.69~0.79				4.5		

Fig.6

[h]. L and 2L size are not applicable for D1100 (2.0mm Pitch) housings

[i]. The contacts are not applicable for crimping multi wires. The strand diameter should be over $\phi 0.1$ mm.

[j]. Solid wire is not applied.

[k]. Apply to use D1000 Hand tool with 2381710-1 by exchange flip locator

[l]. After crimped, check that the crimped sample can be inserted into the housing.

[m]. 2119144-1 with 2381710-1 can be used for crimping if it can be crimped with crimp height 0.49-0.55 mm

[n]. 2119144-1 with 2381710-1 can be used for crimping if it can be crimped with crimp height 0.52-0.57 mm

勝特力電材超市-龍山店 886-3-5773766
 勝特力電材超市-光復店 886-3-5729570
 勝特力電子(上海) 86-21-34970699
 勝特力電子(深圳) 86-755-83298787
<http://www.100y.com.tw>