

REVISIONS					
P	LTR	DESCRIPTION	DATE	DWN	APVD
	U	REVISED PER ECR-23-181664	08AUG2023	AP	DSC

AMP WIRE RANGE	Listed FILE E13288	LR7189 Certified
16-14 AWG SOLID OR STRANDED	16-14 AWG SOLID OR STRANDED	16-14 AWG SOLID OR STRANDED

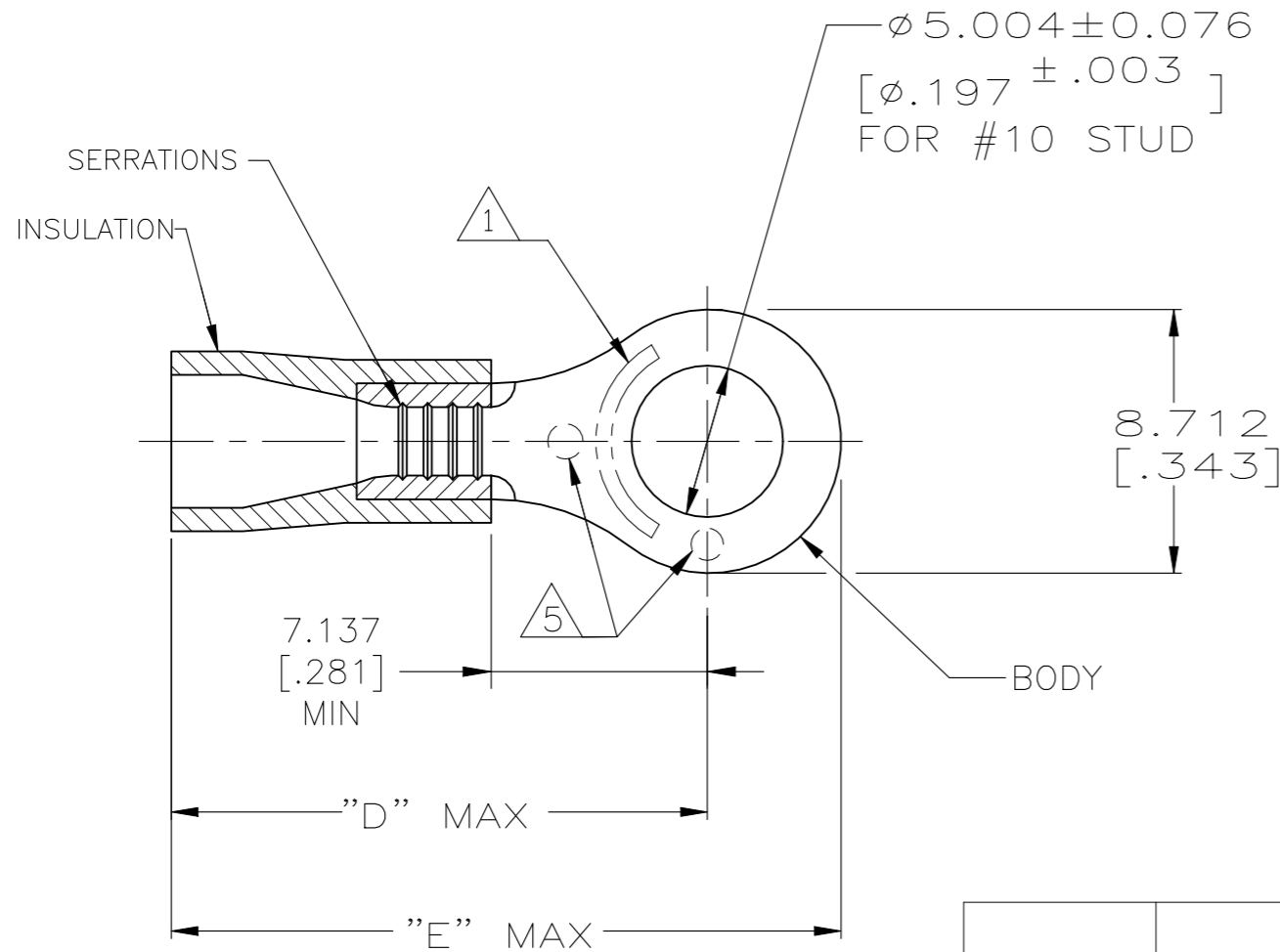

- 1 STAMP AMP 16-14* APPROX AS SHOWN
- 2 BODY MATERIAL THK: 0.787 ± 0.051 $[\ .031 \pm .002]$
- 3 MATERIAL:
BODY - COPPER PER ASTM B152
INSULATION - PVC
- 4 FINISH:
BODY - TIN PLATE 0.00254 $[\ .000100]$
MIN EXT THK PER ASTM B545
INSULATION COLOR - BLUE
- 5 DIMPLE STAMP MARK OPTIONAL

勝特力電材超市-龍山店 886-3-5773766
 勝特力電材超市-光復店 886-3-5729570
 勝特力电子(上海) 86-21-34970699
 勝特力电子(深圳) 86-755-83298787
<http://www.100y.com.tw>

22.123 [.871]	17.704 [.697]	2.997-4.826 [.118-.190]	100	LOOSE PC, BOX	8-34161-1
23.368 [.920]	18.948 [.746]	3.810-6.350 [.150-.250]	5000	ON TAPE, REEL	2-34161-3
			1000	LOOSE PIECE	2-34161-2
22.123 [.871]	17.704 [.697]	2.997-4.826 [.118-.190]	5000	ON TAPE, REEL	2-34161-1
			1000	LOOSE PIECE	34161
"E"	"D"	WIRE INSULATION DIA	QTY	PACKAGE TYPE	PART NUMBER

AMP INCORPORATED CUSTOMER SERVICE SYSTEMS		MAX RECOMMENDED OPERATING TEMPERATURE: 105°C [221° F]	THIS DRAWING IS A CONTROLLED DOCUMENT.		DWN DK SCHRUM 08/06/92	TE Connectivity				
FOR ADDITIONAL PRODUCT INFORMATION OR COPIES OF DRAWINGS AND TECHNICAL DOCUMENTS	PRODUCT INFORMATION CENTER 1-800-522-6752	VOLTAGE RATING: 600V MAX [1000V SIGNS OR FIXTURES]	DIMENSIONS: mm [INCHES]	TOLERANCES UNLESS OTHERWISE SPECIFIED:	CHK RE HERSEY 11/10/92	NAME TERMINAL, RING TONGUE, PLASTI-GRIP, WIRE SIZE: 16-14 AWG				
FOR APPLICATION TOOLING INFORMATION	TOOLING ASSISTANCE CENTER 1-800-722-1111	CIRCULAR MIL AREA: 1.04-2.62mm ² [2,050-5,180] SOLID OR STRANDED		0 PLC ± - 1 PLC ± - 2 PLC ± - 3 PLC ± 0.127[.005] 4 PLC ± - ANGLES ± -	APVD M ELLIS 11/10/92	PRODUCT SPEC UL 486A-B	SIZE	CAGE CODE	DRAWING NO	RESTRICTED TO
FOR ORDER ENTRY	1-800-526-5142	THIS DRAWING IS A CONTROLLED DOCUMENT FOR AMP INCORPORATED. IT IS SUBJECT TO CHANGE AND THE CONTROLLING ENGINEERING ORGANIZATION SHOULD BE CONTACTED FOR THE LATEST REVISION.	MATERIAL 	FINISH 	APPLICATION SPEC 114-2161	WEIGHT -	A3	00779	C-34161	-
CUSTOMER DRAWING						SCALE 4:1	SHEET 1 OF 1	REV U		



NOTE

All numerical values are in metric units [with U.S. customary units in brackets]. Dimensions are in millimeters [and inches]. Unless otherwise specified, dimensions have a tolerance of ± 0.13 [$\pm .005$] and angles have a tolerance of $\pm 2^\circ$. Figures and illustrations are for identification only and are not drawn to scale.

1. INTRODUCTION

This specification covers the requirements for application of PLASTI-GRIP terminals and splices for commercial applications. The terminals and splices consist of precision formed metal wire barrel insulated with vinyl with a maximum operating temperature of 90°C [194°F] for the splices and 105°C [221°F] for the terminals. The ring tongue terminals and butt splices are also available insulated with PVF2 (polyvinylidene fluoride); these terminals and splices can withstand a temperature range of -65 to 150°C [149 to 302°F]. The terminals are also available in heavy duty (HD) for extra mechanical strength. The terminals and splices accept solid or stranded wire for single applications. The flared end of the insulation allows insertion of wires that meet maximum voltage ratings: 600 V for building wiring and 1,000 V for fixture and sign wiring.

The terminals and splices are color coded to provide a visual reference applicable to the wire size range suitable for the terminal or splice. In addition, terminals are marked on the tongue with the wire size range. The serrations or dimples inside the wire barrel provide maximum contact and tensile strength after crimping. The terminals suitable for mounting accept stud sizes M2 [2] through M12 [.50] (a diameter range of 2.18 through 12.7 mm [.086 through .500 in.]). The terminals and splices are available in loose-piece for terminating with manual and pneumatically-powered hand-held tools, and in tape-mounted form for terminating with semi-automatic hand-held tools and electrically-powered machines.

When corresponding with TE Connectivity Personnel, use the terminology provided in this specification to facilitate your inquiries for information. Basic terms and features of this product are provided in Figure 1.

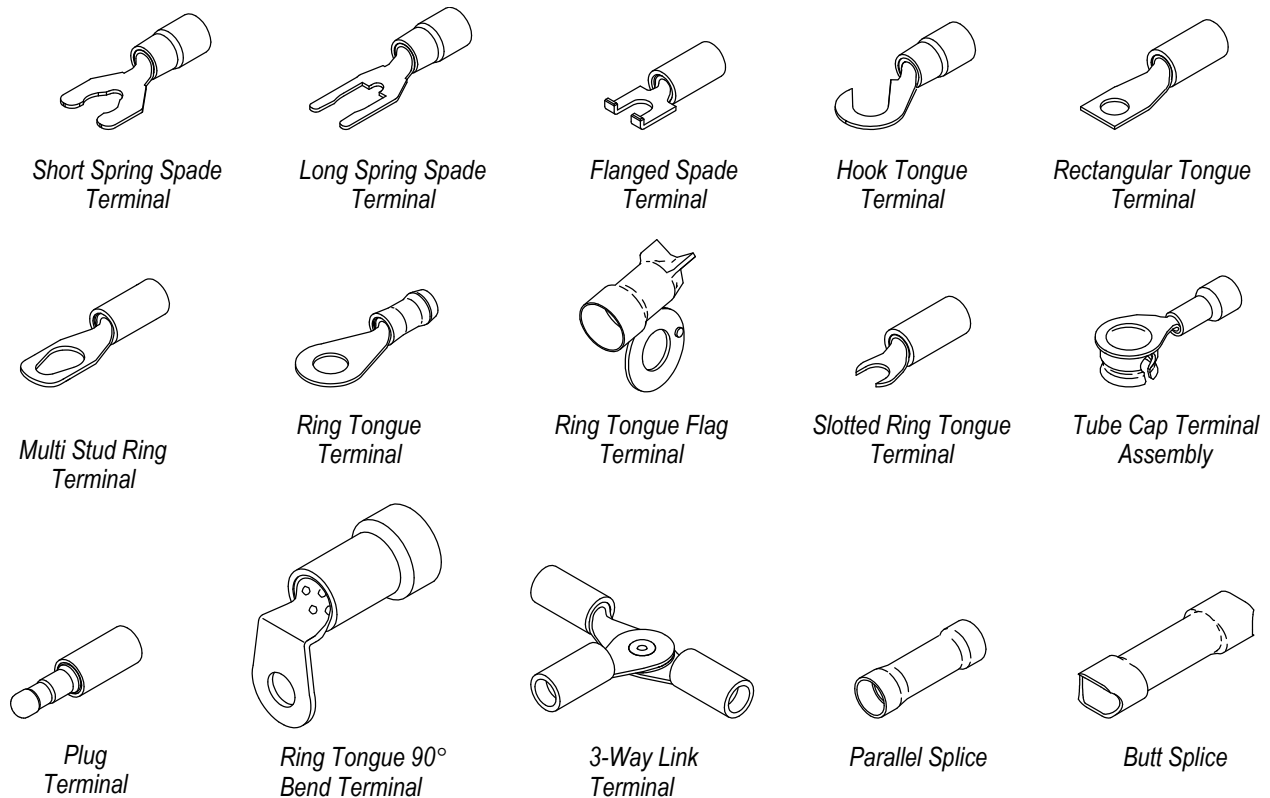

Figure 1

2. REFERENCE MATERIAL

2.1. Revision Summary

- Updated document to corporate requirements
- Added NOTE to Paragraph 2.4 and deleted most reference documentation
- Added text to Section 4, QUALIFICATION
- Added NOTE to Section 5, and deleted reference tooling

2.2. Customer Assistance

Reference Product Base Part Number 32945 and Product Code 3040 are representative of PLASTI-GRIP terminals and splices. Use of these numbers will identify the product line and help you to obtain product and tooling information when visiting www.te.com or calling the number at the bottom of page 1.

2.3. Drawings

Customer drawings for product part numbers are available from www.te.com. Information contained in the customer drawing takes priority.

2.4. Instructional Material

Instruction sheets (408-series) provide product assembly instructions or tooling setup and operation procedures.



NOTE

Because of the large amount of dies, hand tools, applicators, and power units used to terminate this product line, it is not feasible to list all the related tooling documents in this section. Related tooling documents are available through the service network and are also shipped with the specific application tooling.

Some documents which pertain to this product are:

408-7424	Checking Terminal Crimp Height or Gaging Die Closure
408-9816	Handling of Reeled Products

3. REQUIREMENTS

3.1. Safety

Do not stack product shipping containers so high that the containers buckle or deform.

3.2. Special Characteristics

Terminals with an open-ended tongue, such as spade terminals, can be installed and removed without complete removal of the mounting screw. The terminal flat sides provide a locking feature against lateral stress; flanged ends reduce possibility of terminal separation. The snap feature on spring spade terminals increases resistance to axial loads if the mounting screw becomes loosened. The closed-end tongue, in terminals such as ring tongue terminals, provides maximum protection against separation; these terminals are well suited for high vibration environments.

3.3. Material

The terminal body and splice body is made of copper plated with tin-except the spring spade terminal is made of phosphor bronze plated with tin or brass plated with tin, and the .093-Series plug terminal is made of brass. Rivets on the 3-way link terminal and tube cap assembly are made of brass and the tube cap on the tube cap assembly is made of copper zinc alloy. The insulation is made of vinyl or PVF² (polyvinylidene fluoride). The vinyl insulation is highly resistant to abrasion. The PVF² insulation is highly resistant to radiation and solvents.

3.4. Storage

A. Ultraviolet Light

Prolonged exposure to ultraviolet light may deteriorate the chemical composition used in the product material.

B. Shelf Life

The product should remain in the shipping containers until ready for use to prevent deformation to components. The product should be used on a first in, first out basis to avoid storage contamination that could adversely affect performance.

C. Reeled Terminals and Splices

When using tape-mounted reeled terminals or splices, care must be taken to prevent stretching, sagging, or other distortion that would prevent smooth feeding of the tape through automatic machine feed mechanisms. Store coil wound reels horizontally and traverse wound reels vertically.

D. Chemical Exposure

Do not store product near any chemical listed below as they may cause stress corrosion cracking in the material.

Alkalies	Ammonia	Citrates	Phosphates	Citrates	Sulfur Compounds
Amines	Carbonates	Nitrites	Sulfur Nitrites		Tartrates

3.5. Wire Selection and Preparation

The terminals and splices will accept solid or stranded copper wire sizes 26 through 1/0 AWG and stranded wire sizes 8 through 2/0 AWG (509 through 150,500 circular mil area) with an insulation diameter range of 1.27 through 19.69 mm [.050 through .775 in.]. Proper strip length is necessary to properly insert the wire into the terminal or splice. The strip length of the wire is shown in Figure 2.



CAUTION

Reasonable care must be taken not to nick, scrape, or cut any strands during the stripping operation.

3.6. Wire Placement

Stranded wire conductors must be inside the terminal or splice wire barrel. No strands can be folded back over the wire insulation. Conductor ends must be bottomed in the wire barrel. The wire insulation must be inside the insulation of the terminal or splice, but must not enter the wire barrel, to provide strain relief for the wire.

3.7. Crimp Requirements

The terminal or splice must be crimped to the wire according to instructions packaged with applicable tooling.

A. Wire Barrel Crimp

The crimp applied to the wire barrel portion of the terminal or splice is the most compressed area and is most critical in ensuring optimum electrical and mechanical performance of the crimped terminal or splice. The crimped area must be symmetrical on both sides of the wire barrel of the terminal or splice. The crimp may be off center on the wire barrel but not off the end of the wire barrel. See Figure 3.

B. Crimp Dot Code

Some tools with multiple crimping chambers will emboss a crimp dot code onto the terminal or splice insulation when crimped. The crimp dot code must be fully formed on the insulation to indicate that the correct product and tooling combination was used. The crimp dot code must correspond with the wire size marking on the tooling. See Figure 3.

C. Wire Conductor and Insulation Location

After crimping, all conductors must be held firmly inside the wire barrel. No strands can be folded back over the wire insulation. The wire insulation must be inside the insulation barrel of the terminal or splice, but must not enter the wire barrel. Conductor ends must be flush with, or extend slightly beyond, the end of the wire barrel; or, in splices with a wire stop inside the center of the splice, conductor ends must butt against the wire stop. See Figure 3.



CAUTION

Wire insulation shall NOT be cut or broken during the crimping operation. Reasonable care should be taken to provide undamaged wire terminations.

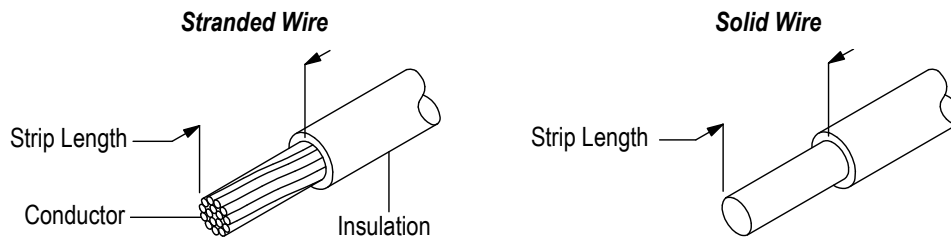

TERMINAL OR SPLICE		WIRE INSULATION DIA RANGE	WIRE STRIP LENGTH			WIRE CIRCULAR MILL AREA (CMA)
SIZE	INSULATION COLOR		TERMINAL	BUTT SPLICE	PARALLEL SPLICE	
26-22	Yellow	1.27-2.03 [.050-.080]	---	4.34-5.16 [.171-.203]	---	202-810
24-20	White	2.03-3.18 [.080-.125]	4.75-5.54 [.187-.218]	---	---	320-1,290
22-16	Red	---	5.16-5.94 [.203-.234]	6.35-7.14 [.250-.281]	7.87-8.64 [.310-.340]	509-3,260
	Natural/Red	---				
	Black	---				
20-16 HD	Natural/Green	2.92-4.32 [.115-.170]	5.16-5.94 [.203-.234]	---	---	810-3,260
16-14	Blue	---	5.16-5.94 [.203-.234]	6.35-7.14 [.250-.281]	7.87-8.64 [.310-.340]	2,050-5,180
	Natural/Blue	---				
	Black	---				
16-14 HD	Yellow/Black	---	7.92-8.71 [.312-.343]	---	---	2,050-5,180
	Black	---				
12-10	Yellow	---	7.92-8.71 [.312-.343]	7.92-8.71 [.312-.343]	7.92-8.71 [.312-.343]	5,180-13,100
	Natural/Yellow	---				
	Black	---				
8	Red	---	11.51-12.29 [.453-.484]	8.33-9.12 [.328-.359]	---	13,100-20,800
	Natural/Red	---	8.33-9.12 [.328-.359]	---	---	
6	Blue	---	15.47-16.26 [.609-.640]	9.93-10.72 [.391-.422]	---	20,800-33,100
	Natural/Blue	---	9.93-10.72 [.609-.640]	---	---	
4	Yellow	---	15.47-16.26 [.609-.640]	---	---	33,100-52,600
	Natural/Yellow	1.27-13.08 [.050-.515]	9.93-10.72 [.609-.640]	---	---	
2	Red	---	11.51-12.29 [.453-.484]	---	---	52,600-83,700
	Natural/Red	12.19-14.22 [.480-.560]	11.51-12.29 [.453-.484]	---	---	
1/0	Blue	---	18.67-21.82 [.735-.859]	---	---	83,700-119,500
2/0	Yellow	---	18.67-21.82 [.735-.859]	---	---	119,500-150,500
	Natural/Yellow	16.00-19.68 [.630-.775]	18.67-21.82 [.735-.859]	---	---	

Figure 2

D. Terminal or Splice Insulation

The terminal or splice insulation must not be deformed, cut, or show uneven stress marks. See Figure 3.

E. Bellmouth

There shall be no rear bellmouth. The front bellmouth shall be evident as shown in Figure 3.

Terminal

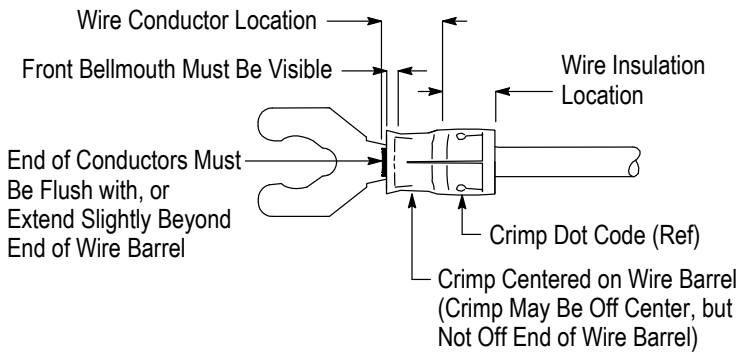

Plug Terminal

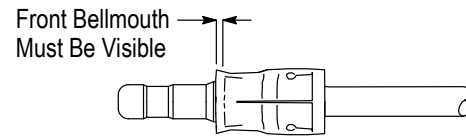

Splice

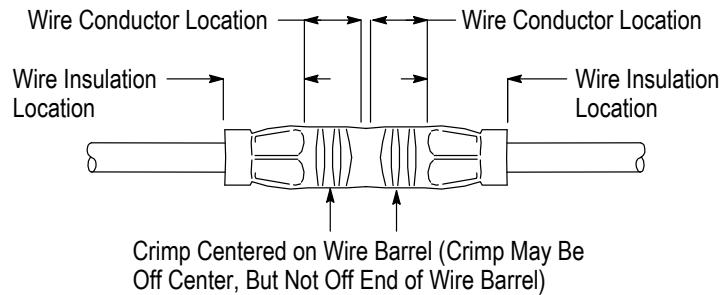

TERMINAL OR SPLICE SIZE	SOLDER SLUG		
	DIAMETER	CRIMP HEIGHT RANGE (See Notes)	
		CRESCENT CRIMP	CRIMP PRODUCED BY TETRA-CRIMP* TOOLING
26-22	3.18 [.125]	1.60-1.75 [.063-.069]	---
24-20		2.26-2.41 [.089-.095]	
22-16	3.18 [.125]	2.77-2.92 [.109-.115]	1.98-2.18 [.078-.086]
20-16 HD	4.76 [.188]	3.02-3.18 [.119-.125]	2.34-2.54 [.092-.100]
16-14			
16-14 HD	6.35 [.250]	4.29-4.44 [.169-.175]	3.25-3.45 [.128-.136]
12-10			
8	6.35 [.250]	5.11-5.26 [.201-.207]	---
6	6.35 [.250]	6.02-6.17 [.237-.243]	---
4	9.53 [.375]	6.83-6.98 [.269-.275]	---
2	9.53 [.375]	8.10-8.26 [.319-.325]	---
1/0	12.70 [.500]	10.19-10.34 [.401-.407]	---
2/0	12.70 [.500]	10.67-12.83 [.499-.505]	---

NOTE

The resilience of the terminal and splice insulation prevents accurate direct measurement of crimp height. Crimp height can be obtained by measuring a crimped solder slug (60% tin and 40% lead) with a diameter comparable to the wire size. The slug must be measured over the most compressed area of the slug with a standard micrometer or crimp height comparator (refer to Instruction Sheet 408-7424 for specific instructions). The solder slug diameter and crimp height must be within the dimensions provided.

NOTE

Each crimp dimension represents the functional range of a wire/terminal or splice combination. There are tool designs available to meet various application requirements. The developed crimp configuration is unique for each tool design and is acceptable provided the crimp height is within the functional range. For crimp dimensions of a specific tool, refer to instruction sheet packaged with manual tools and applicator log packaged with power tools.

Figure 3

F. Tensile Strength

Crimped terminals or splices must hold the wire firmly and have a crimp pull-out test value meeting that specified in Figure 4.



NOTE

Adjust tensile testing machine for head travel of 25.4 mm [1.0 in.] per minute. Directly and gradually apply force for one minute.

WIRE SIZE (AWG)	TENSILE FORCE (N [lb]) Min
26	13.4 [3]
24	22.3 [5]
22	35.6 [8]
20	57.9 [13]
18	89.0 [20]
16	133.5 [30]
14	222.5 [50]
12	311.5 [70]
10	356.0 [80]
8	400.5 [90]
6	445.0 [100]
4	623.0 [140]
2	801.0 [180]
1/0	1112.5 [250]
2/0	1235.0 [300]

Figure 4

G. Bend Allowance

The force applied during crimping may cause some bending between the wire barrel and wire. Such deformation is acceptable within the following limits.

1. Up and Down

The crimped portion must not be bent beyond the limits shown in Figure 5.

2. Side-to-Side

The crimped portion must not be bent from one side to the other beyond the limits shown in Figure 5.

3.8. Repair

Damaged terminals and splices or terminals and splices that do not meet crimp dimension requirements must be removed from wires, discarded, and replaced with new ones. When removing a terminal or splice, cut the wires as close as possible to the end of the wire barrel.

4. QUALIFICATION

Most PLASTI-GRIP terminals and splices are Listed by Underwriters Laboratories Inc. (UL) in File E13288, and Certified by CSA International in File LR7189; except multi stud ring, ring tongue bent 90°, and tube cap terminals.

5. TOOLING

Hand tools for manual application of loose piece terminals and splices, and automatic and semi-automatic machines for power assisted application of tape-mounted terminals and splices are available to cover the full wire size range.

Up and Down Bend

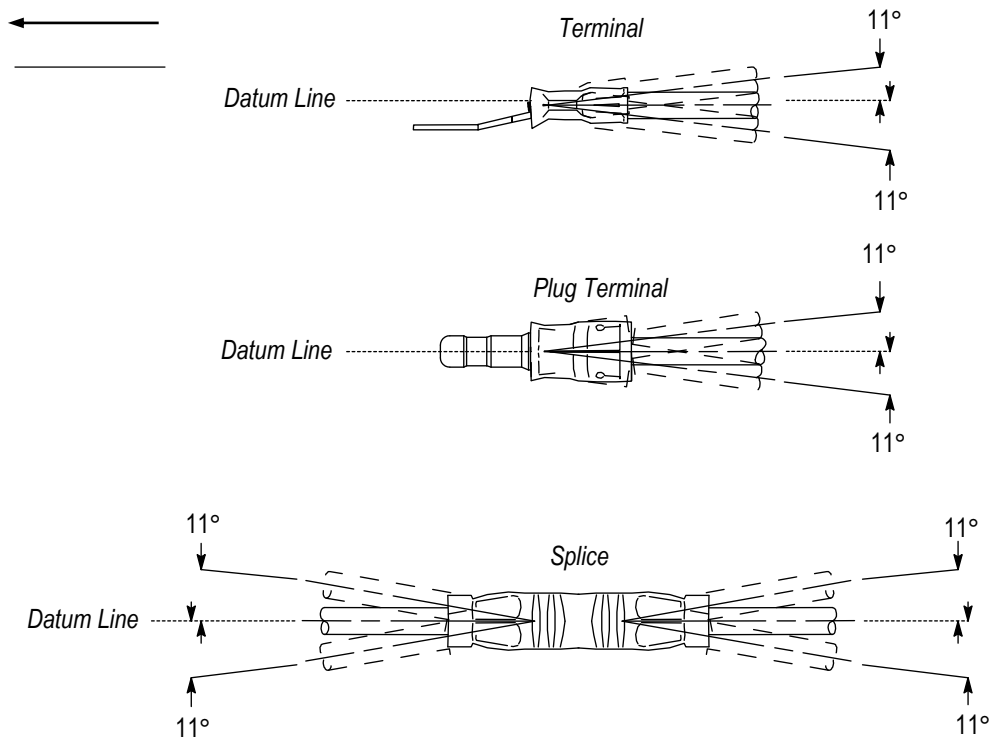

Side-to-Side Bend

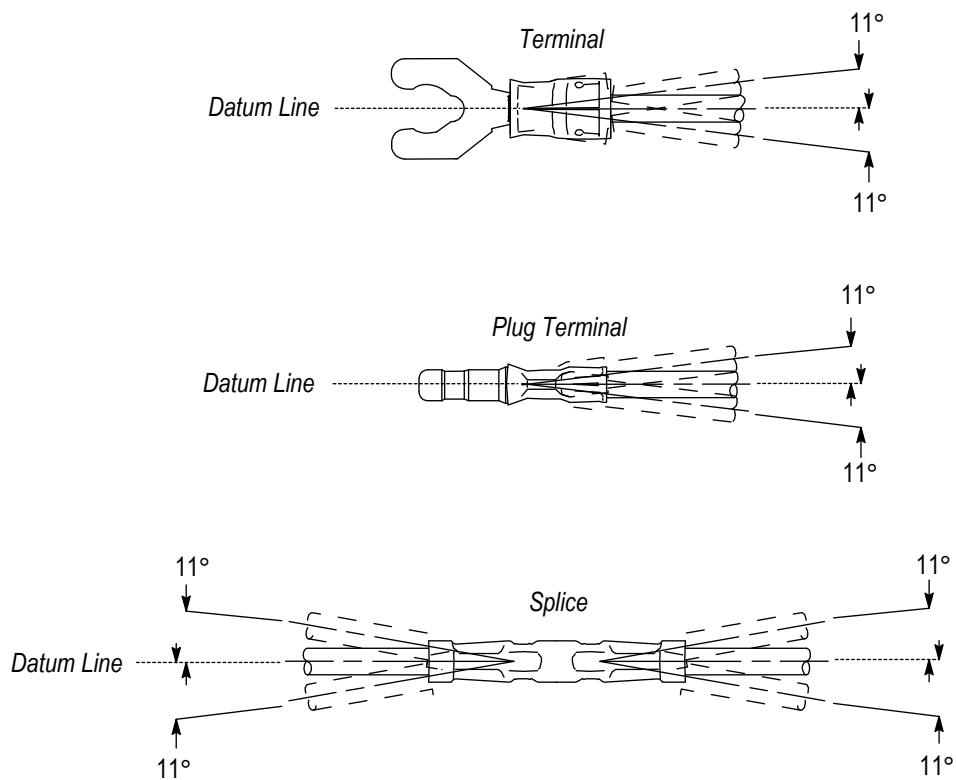

Figure 5

**NOTE**

Because of the large amount of product variations and application tooling available, it is not feasible to list all the tooling on this document. Contact TE using the phone number listed at the bottom of Page 1 for specific dies, hand tools, applicators, and power units to fit your production needs and requirements.

5.1. Hand Crimping Tool

The hand crimping tools consist of a handle assembly with integral fixed jaws or fixed dies, or a head that accepts various die assemblies. The jaws or dies have one or more crimping chambers used to crimp terminals and splices onto pre-stripped wire. The hand tool assemblies have a ratchet, except the hydraulic hand crimping tool which uses hydraulic fluid, to ensure full crimping pressure is applied to the terminal or splice.

5.2. 626 Pneumatic Tooling System

The pneumatic tooling system consists of a pneumatic power unit, tool holder assembly, and variety of crimping heads used to crimp terminals and splices onto pre-stripped wire. This tooling system was developed to reduce operator fatigue and provide interchangeability of die assemblies. The system is designed for prototype and medium-volume application of loose piece terminals and splices.

5.3. Pneumatic Tool

The pneumatic tool uses a pneumatic crimping head which contains jaws to crimp terminal and splices onto pre-stripped wires. This tool uses a filter and moisture separator, regulator, and lubricator. This tool is designed for low-volume application.

5.4. Applicator

The applicators are designed to crimp tape-mounted terminals and splices onto pre-stripped wire, for high volume, heavy duty production requirements. These applicators accept interchangeable crimping dies and must be installed onto a power unit.

5.5. Power Unit**A. Hydraulic Machine**

The hydraulic power units combine the convenience of a hand tool with the power of a larger machine to crimp loose piece terminals and splices onto pre-stripped wire. Each unit uses a hydraulic head and interchangeable dies. These units are, basically, a portable crimping unit which uses a handle or foot control to activate a pump. They are used primarily for low-volume production or at locations where electrical power sources are not readily available.

B. Pneudraulic Machine

Pneudraulic power units provide the force required for automatic crimping tape-mounted terminals and splices. These machines accept interchangeable dies and are air-operated using a foot valve. These machines use a filter and moisture separator, regulator, and lubricator and are designed to be bench-mounted.

C. Semi-Automatic Machine

These power units provide the force required to drive applicators for crimping tape-mounted terminals and splices. They provide for medium-volume applications. These machines are designed to be bench mounted.

D. Automatic Machine

These power units provide the force required to drive applicators for crimping tape-mounted terminals and splices. They can be set up to automatically measure, cut, strip, and terminate wire. They provide for high volume, heavy duty production requirements. These machines are designed to be floor standing.

6. VISUAL AID

The illustration below shows a typical application of this product. This illustration should be used by production personnel to ensure a correctly applied product. Applications which do not appear correct should be inspected using the information in the preceding pages of this specification and in the instructional material shipped with the product or tooling.

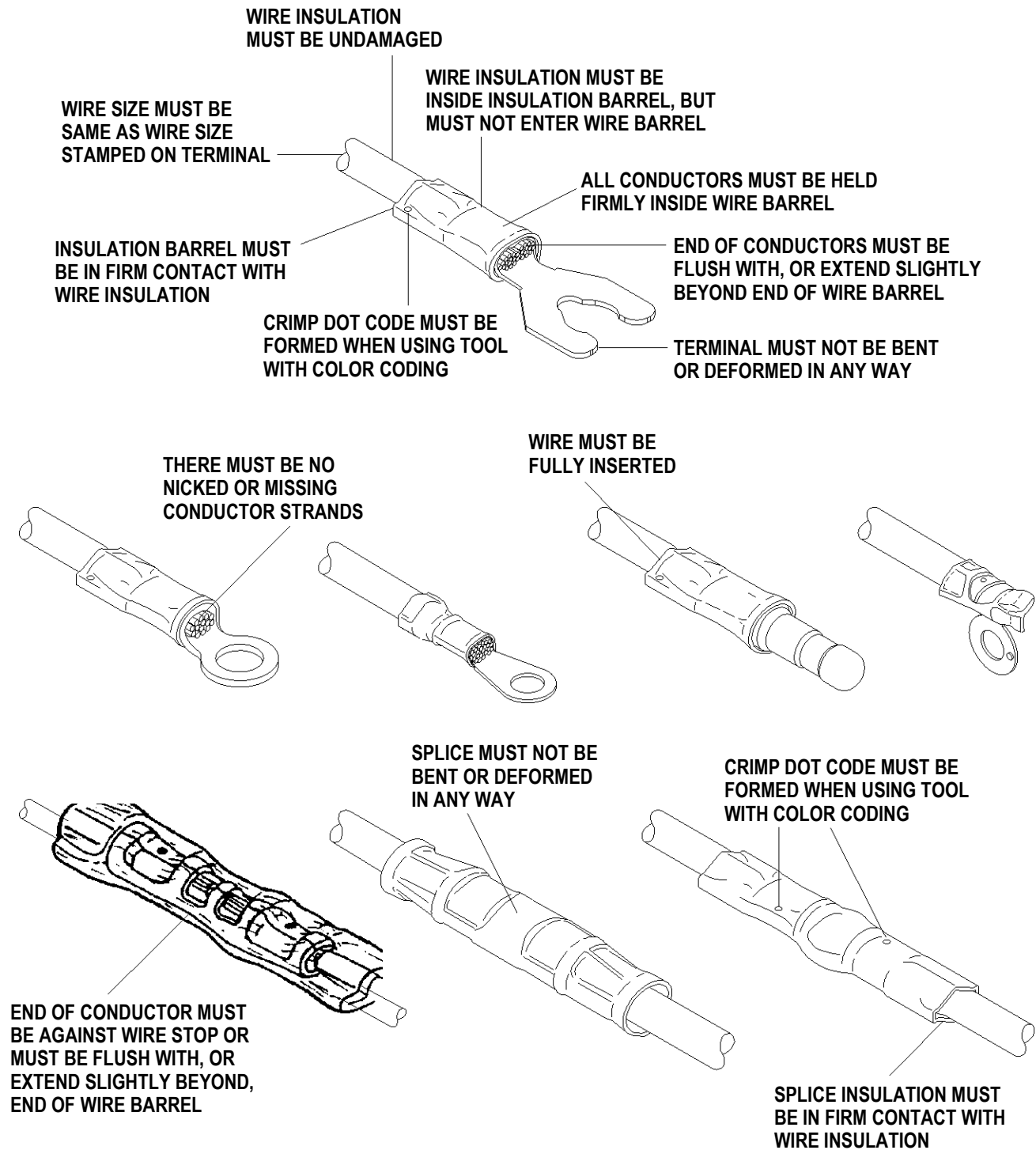

FIGURE 6. VISUAL AID