

THIS DRAWING IS UNPUBLISHED. RELEASED FOR PUBLICATION
 © COPYRIGHT - By - ALL RIGHTS RESERVED.

LOC		DIST		REVISIONS			
P	LTR	DESCRIPTION		DATE	DWN	APVD	
AD	00	AE	REVISED PER ECO-15-004633	30MAY2015	NK	JO	

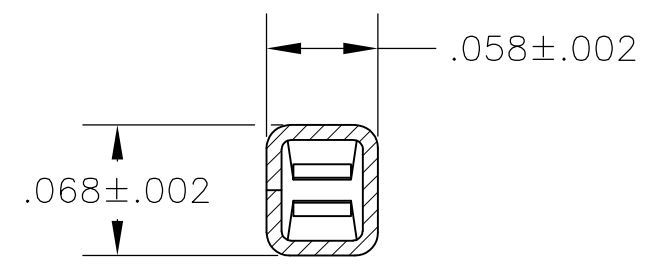

SECTION A-A

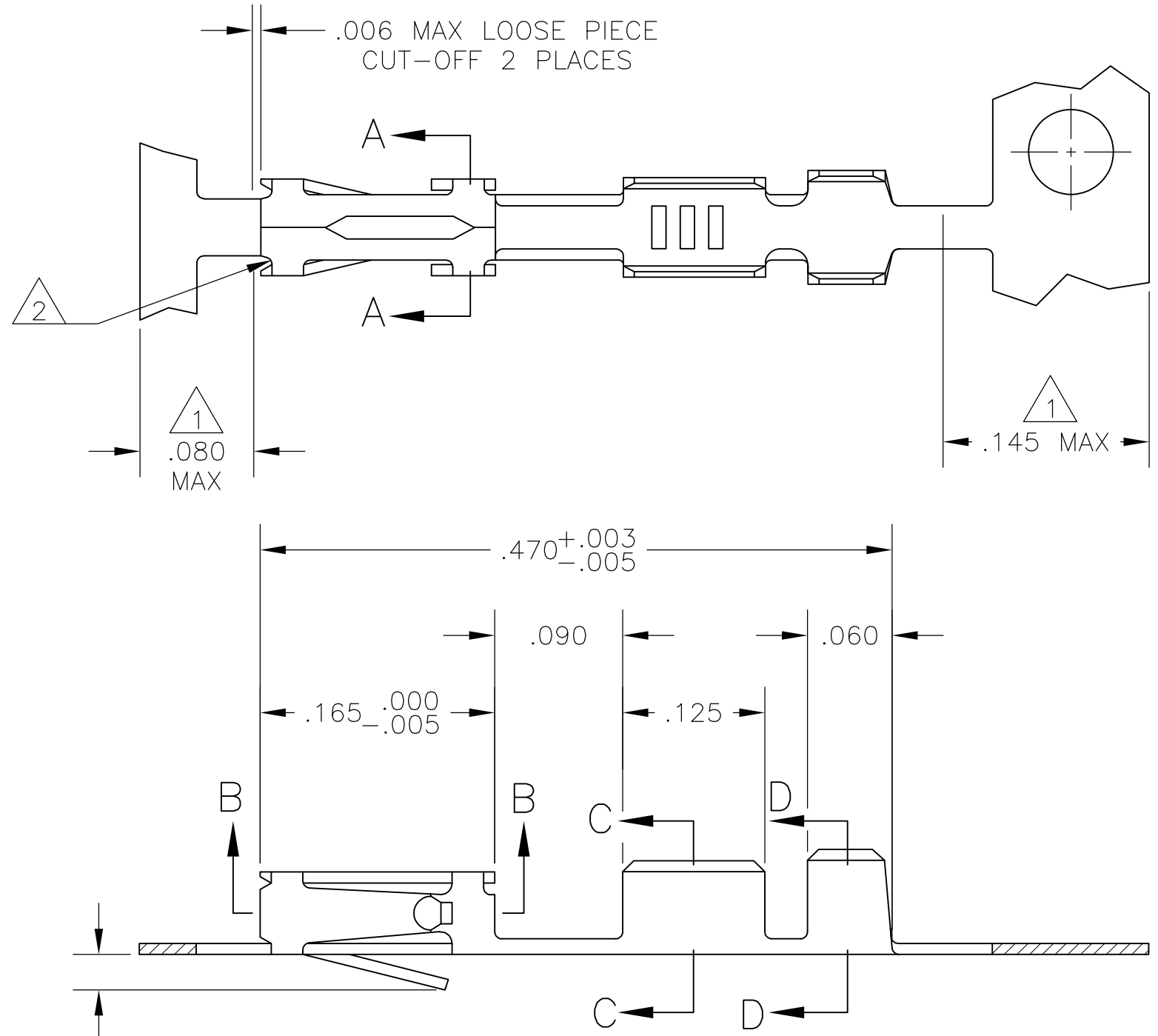
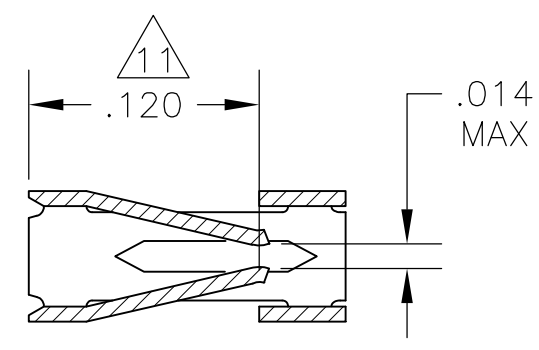

SECTION B-B

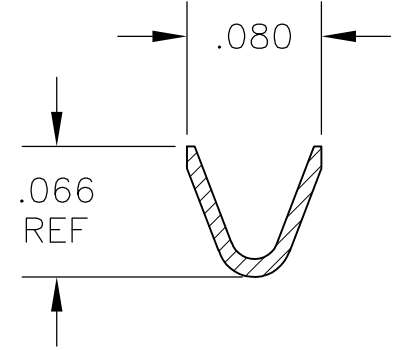

WIRE SIZE #24-#20
SECTION C-C

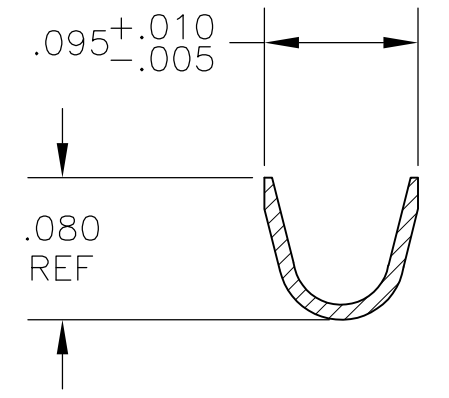

INSULATION RANGE .069 MAX
SECTION D-D

- 1 GOLD PLATING IS NOT REQUIRED IN THIS AREA.
- 2 CUT-OUTS ON THE BOX ARE AT MANUFACTURERS OPTION.
- 3 THIS TERMINAL IS REELED FOR THE STANDARD APPLICATOR.
- 4 THIS TERMINAL IS REELED FOR THE MINI APPLICATOR.
- 5 .000030 GOLD OVER .000050 NICKEL.
- 6 .000030 GOLD ON THE CONTACT AREA, GOLD FLASH ON THE REMAINDER ALL OVER .000050 NICKEL.
- 7 PREPLATED:(HALT) .000078-.000158 BRIGHT TIN.
- 8 .000050 GOLD OVER .000050 NICKEL.
- 9 .000015 GOLD ON THE CONTACT AREA, GOLD FLASH ON THE REMAINDER ALL OVER .000050 NICKEL.
- 10 .000050 GOLD ON THE CONTACT AREA, GOLD FLASH ON THE REMAINDER ALL OVER .000050 NICKEL.
- 11 POINT OF MEASUREMENT FOR PLATING THICKNESS (INSIDE BEAMS).
- 12 .000015 GOLD IN CONTACT AREA, .000050 NICKEL ON ENTIRE TERMINAL.
- 13 OBSOLETE PART NUMBER.
- 14 OBSOLETE PARTS: OBSOLETE CIS STREAMLINING PER D.RENAUD/D.SINISI.

勝特力電材超市-龍山店 886-3-5773766
 勝特力電材超市-光復店 886-3-5729570
 勝特力电子(上海) 86-21-34970699
 勝特力电子(深圳) 86-755-83298787
<http://www.100y.com.tw>

4	12	13 -7	13 2-85969-0
3	12	13 -7	1-85969-9
3	10	13 -6	1-85969-8
4	10	13 -6	1-85969-7
4	8	86016-4	1-85969-0
4	7	86016-3	85969-9
4	6	86016-2	85969-8
4	5	86016-1	85969-7
4	9	86016-5	85969-6
3	9	86016-5	13 85969-5
3	8	86016-4	14 85969-4
3	7	86016-3	13 85969-3
3	6	86016-2	85969-2
3	5	86016-1	85969-1

SUPERSEDED BY 85969-4

DIMENSIONS:		TOLERANCES UNLESS OTHERWISE SPECIFIED:		DWN		10DEC85	
INCHES		0 PLC	± -	L.D.RINGLEY		16DEC85	
		1 PLC	± -	CHK J.L.GESFORD		16DEC85	
		2 PLC	± -	APVD J.L.GESFORD		16DEC85	
		3 PLC	± .005	PRODUCT SPEC		108-25, 020	
		4 PLC	± -	APPLICATION SPEC		114-25, 003	
MATERIAL		FINISH		WEIGHT		SCALE	
CU-NI-SI		SEE TABLE		-		A2 00779 C=85969	
CUSTOMER DRAWING				SCALE		SHEET	
				10:1		1 of 1	



CONTACT, MOD IV,
RECEPTACLE, CRIMP
SNAP-IN

85969

B

A



**Interconnection System, AMPMODU* Mod IV, Wire-To-Board,
Standard Pressure Tin Contacts**

1. SCOPE

1.1. Content

This specification covers performance, tests and quality requirements for AMPMODU* Mod IV interconnection system. This miniature system consists of standard pressure receptacle contacts crimped onto either solid or stranded wire and then inserted into a Mod IV housing. This system is designed to mate with AMPMODU Mod II 0.025 inch square posts or headers.

1.2. Qualification

When tests are performed on the subject product line, procedures specified in Figure 1 shall be used. All inspections shall be performed using the applicable inspection plan and product drawing.

1.3. Qualification Test Results

Successful qualification testing on the subject product line was completed on 05Mar99. The Qualification Test Report number for this testing is 501-313-1. This documentation is on file at and available from Global Engineering and Manufacturing Standards (GEMS).

2. APPLICABLE DOCUMENTS

The following documents form a part of this specification to the extent specified herein. Unless otherwise specified, the latest edition of the document applies. In the event of conflict between the requirements of this specification and the product drawing, the product drawing shall take precedence. In the event of conflict between the requirements of this specification and the referenced documents, this specification shall take precedence.

2.1. AMP Documents

- A. 109-1: General Requirements for Test Specifications
- B. 109 Series: Test Specifications as indicated in Figure 1
- C. Corporate Bulletin 401-76: Cross-reference between AMP Test Specifications and Government or Commercial Documents
- D. 108-25020: Product Specification
- E. 114-25003: Application Specification
- F. 501-313-1: Qualification Test Report

3. REQUIREMENTS

3.1. Design and Construction

Product shall be of the design, construction and physical dimensions specified on the applicable product drawing.

3.2. Materials

Materials used in the construction of this product shall be as specified on the applicable product drawing.

3.3. Ratings

- A. Voltage: 250 vac
- B. Current: See Figure 4 for applicable current carrying capability
- C. Temperature: -65 to 85°C

3.4. Performance and Test Description

Product is designed to meet the electrical, mechanical and environmental performance requirements specified in Figure 1. Unless otherwise specified, all tests shall be performed at ambient environmental conditions per AMP Specification 109-1.

3.5. Test Requirements and Procedures Summary

Test Description	Requirement	Procedure
Examination of product.	Meets requirements of product drawing and AMP Spec 114-25003.	Visual and functional per applicable quality inspection plan.
ELECTRICAL		
Dry circuit resistance.	20 milliohms maximum.	AMP Spec 109-6-6. Subject samples to 20 mv maximum open circuit voltage at 100 ma maximum. See Figure 3.
Temperature rise vs current.	30°C maximum temperature rise at specified current.	AMP Spec 109-45-2. Measure temperature rise vs current. See Figure 4.
MECHANICAL		
Vibration, sinusoidal.	No discontinuities of 1 microsecond or longer duration. See Note.	AMP Spec 109-21-2. Subject mated samples to 10-500-10 Hz traversed in 15 minutes with 0.06 inch maximum total excursion. 1.3 hours in each of 3 mutually perpendicular planes. See Figure 5.
Mechanical shock, specified pulse.	No discontinuities of 1 microsecond or longer duration. See Note.	AMP Spec 109-26-9. Subject mated samples to 100 G's sawtooth shock pulses of 6 milliseconds duration. 3 shocks in each direction applied along 3 mutually perpendicular planes, 18 total shocks. See Figure 5.
Durability.	See Note.	AMP Spec 109-27. Mate and unmate samples for 30 cycles at a maximum rate of 600 cycles per hour.

Figure 1 (cont)

Test Description	Requirement	Procedure
Mating force.	9 ounces per contact maximum average.	AMP Spec 109-42, Condition A. Measure force necessary to mate samples a distance of 0.230 inch from point of initial contact with housing face at a maximum rate of 1.0 inch per minute.
Unmating force.	1.5 ounces per contact minimum average.	AMP Spec 109-42, Condition A. Measure force necessary to unmate samples at a maximum rate of 1.0 inch per minute.
ENVIRONMENTAL		
Humidity-temperature cycling.	See Note.	AMP Spec 109-23-3, Condition B. Subject mated samples to 10, 24 hour cycles between 25 and 65°C at 95% RH.
Temperature life.	See Note.	AMP Spec 109-43. Subject mated samples to temperature life at 85°C for 500 hours.

NOTE *Shall meet visual requirements, show no physical damage, and meet requirements of additional tests as specified in the Product Qualification and Requalification Test Sequence shown in Figure 2.*

Figure 1 (end)

3.6. Product Qualification and Requalification Test Sequence

Test or Examination	Test Group (a)	
	1	2
	Test Sequence (b)	
Examination of product	1,9	1,9
Dry circuit resistance	3,7	2,7
Temperature rise vs current		3,8
Vibration	5	6(c)
Mechanical shock	6	
Durability	4	
Mating force	2	
Unmating force	8	
Humidity-temperature cycling		4(d)
Temperature life		5

NOTE

- (a) See Para 4.1.A.
- (b) Numbers indicate sequence in which tests are performed.
- (c) Discontinuities shall not be measured. Energize at 18°C level for 100% loadings per AMP Specification 109-151.
- (d) Precondition samples with 3 cycles durability.

Figure 2

4. QUALITY ASSURANCE PROVISIONS

4.1. Qualification Testing

A. Sample Selection

Samples shall be prepared in accordance with applicable Instruction Sheets and shall be selected at random from current production. All test groups shall each consist of 3 samples.

B. Test Sequence

Qualification inspection shall be verified by testing samples as specified in Figure 2.

4.2. Requalification Testing

If changes significantly affecting form, fit or function are made to the product or manufacturing process, product assurance shall coordinate requalification testing, consisting of all or part of the original testing sequence as determined by development/product, quality and reliability engineering.

4.3. Acceptance

Acceptance is based on verification that the product meets the requirements of Figure 1. Failures attributed to equipment, test setup or operator deficiencies shall not disqualify the product. If product failure occurs, corrective action shall be taken and samples resubmitted for qualification. Testing to confirm corrective action is required before resubmittal.

4.4. Quality Conformance Inspection

The applicable AMP quality inspection plan shall specify the sampling acceptable quality level to be used. Dimensional and functional requirements shall be in accordance with the applicable product drawing and this specification.

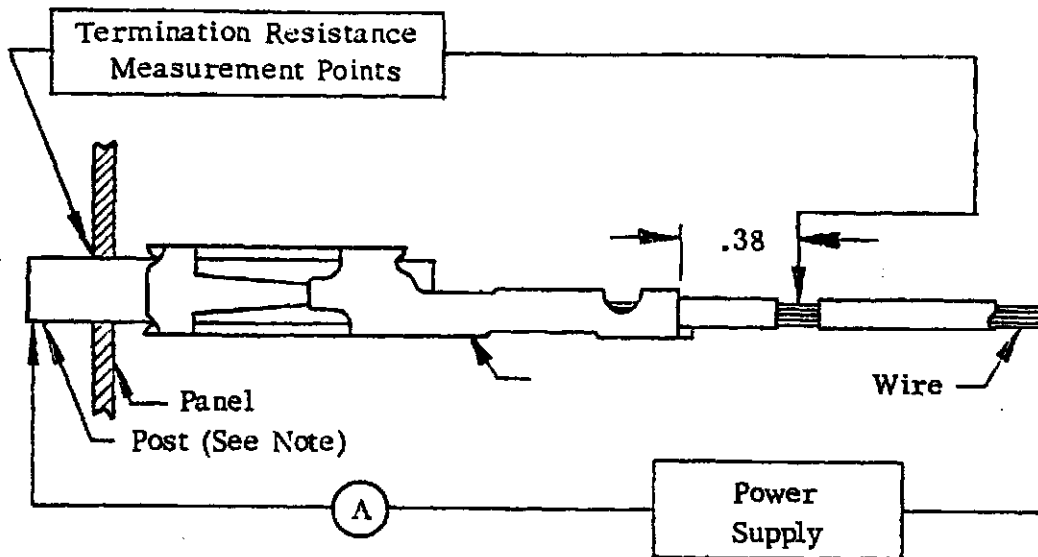

Figure 3
Termination Resistance Measurement Points

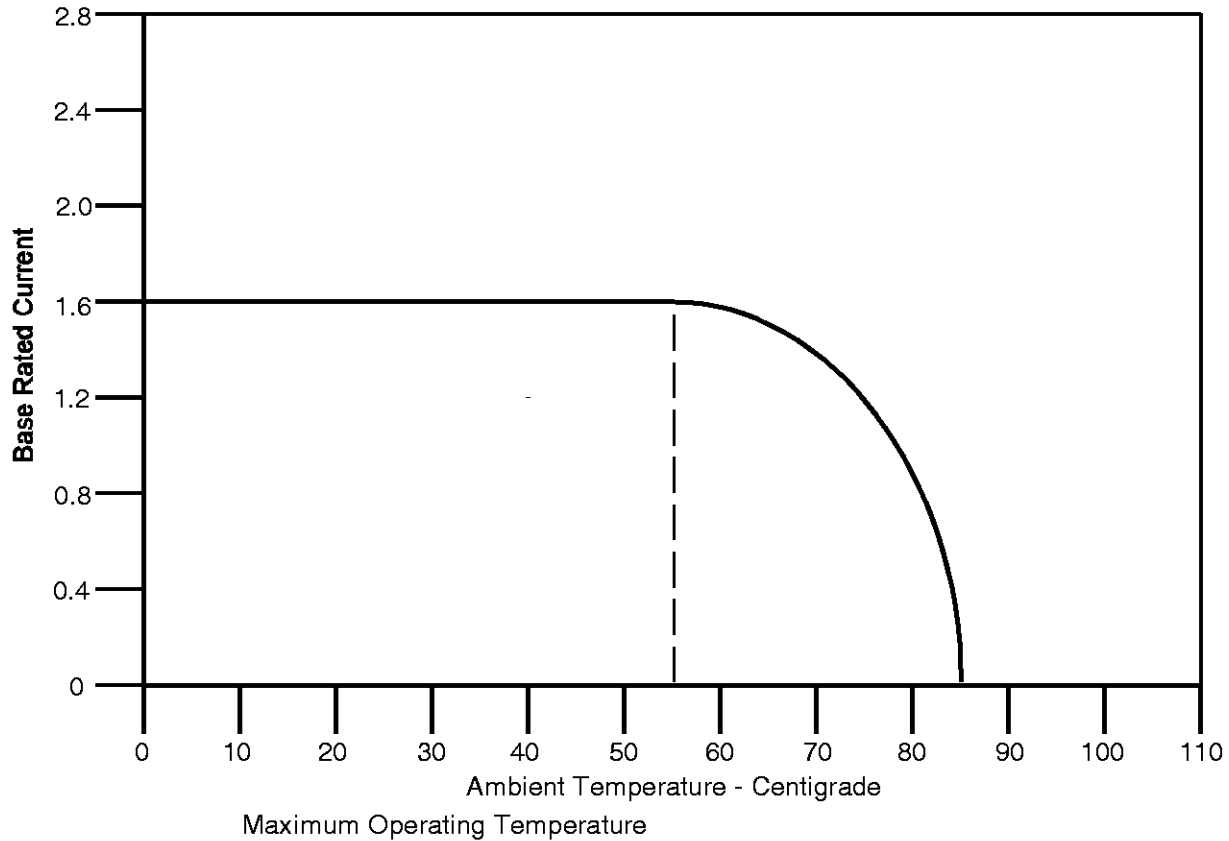

Figure 4A
Current Carrying Capability

Percent Connector Loading	Wire Size AWG						
	32	30	28	26	24	22	20
Single Contact	.64	.68	.73	.78	.84	.91	1.06
50	.38	.40	.43	.46	.49	.54	.59
100	.29	.31	.33	.36	.38	.42	.46

NOTE

To determine acceptable current carrying capacity for percentage connector loading and wire gage indicated, use the Multiplication Factor (F) from the above chart and multiply it times the Base rated Current for a single circuit at the maximum ambient operating temperature shown in Figure 4A.

Figure 4B
Current Rating

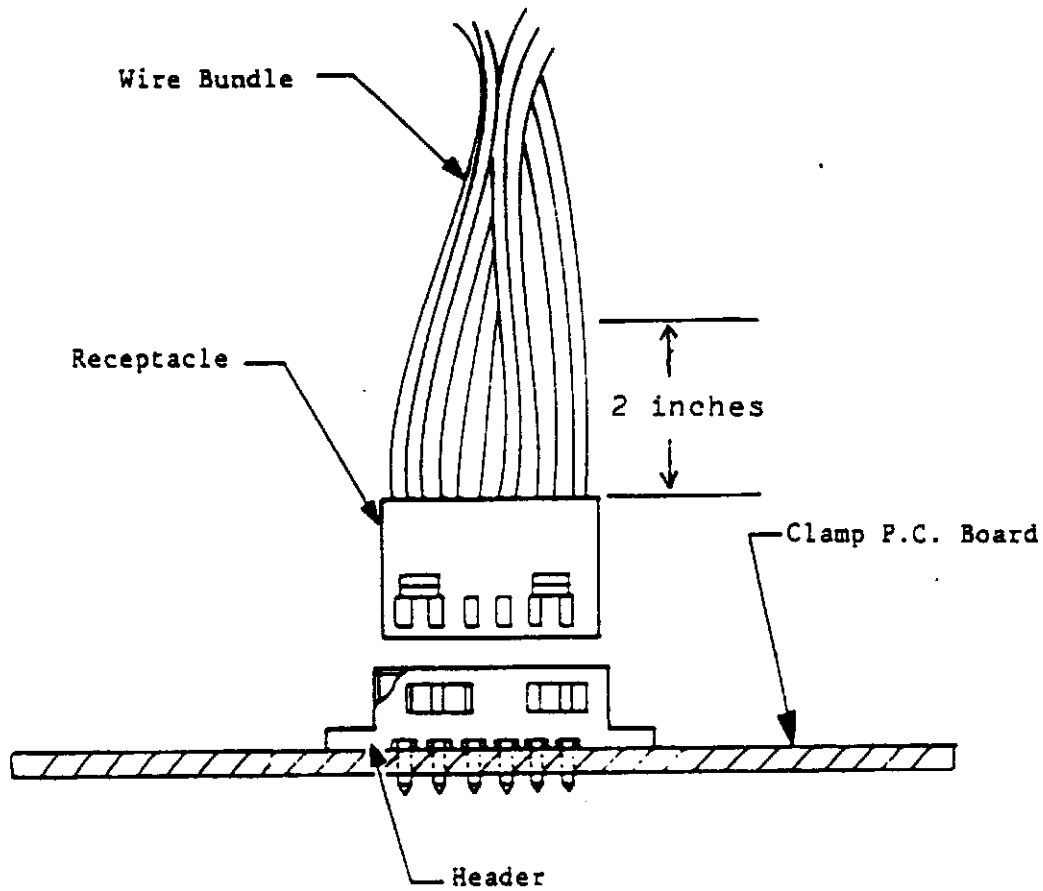

Figure 5
Vibration & Mechanical Shock Mounting Fixture

勝特力電材超市-龍山店 886-3-5773766
勝特力電材超市-光復店 886-3-5729570
勝特力电子(上海) 86-21-34970699
勝特力电子(深圳) 86-755-83298787
<http://www.100y.com.tw>