

THIS DRAWING IS UNPUBLISHED.

RELEASED FOR PUBLICATION

© COPYRIGHT

BY TE CONNECTIVITY

ALL RIGHTS RESERVED.

REVISIONS

P	LTR	DESCRIPTION	DATE	DWN	APVD
	0	RELEASED	28.MAR.'02	HS	CS
	A	REVISED (ECR-09-002852)	10.FEB.'09	KT	HG
	B	REVISED (ECR-23-175821)	22MAR2023	SY	KT
ⓑ	BI	REVISED (ECR-23-189459)	12OCT2023	SY	KT

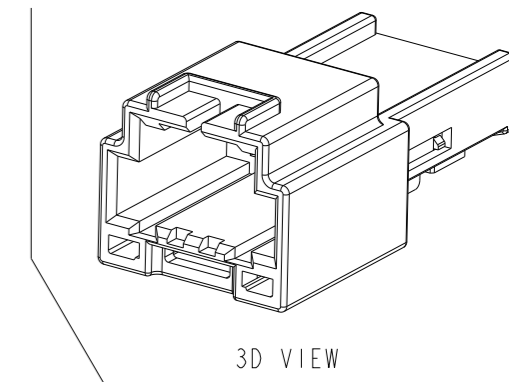
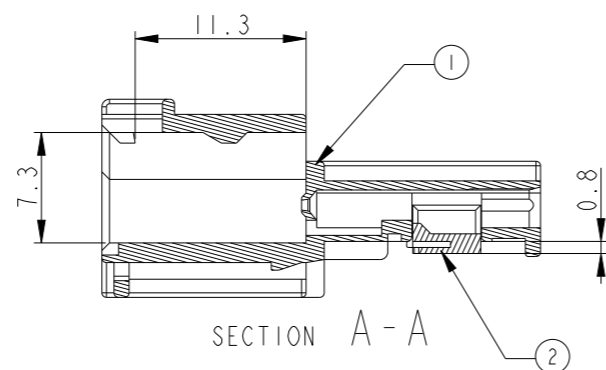
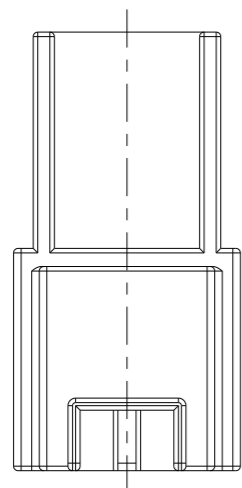

NOTES

- 1. GENERAL TOLERANCE IS  $\pm 0.3$
- 2. CONDITION OF DELIVERY : DBL IN 1st LOCKING POSITION
- 3. APPLIED CLIP HSG:

PART NO.	PANEL THICKNESS	PANEL HOLE SIZE
368165	0.7~1.6mm	
368373	0.5~2.0mm	

- 4. APPLIED PLUG ASS'Y P/N: 936119
- 5. APPLIED TAB CONTACT P/N:

PART NO.	928918	963716
WIRE SIZE(mm <sup>2</sup> )	0.25~0.5	0.75

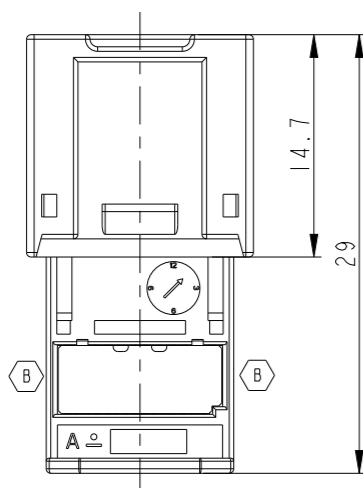
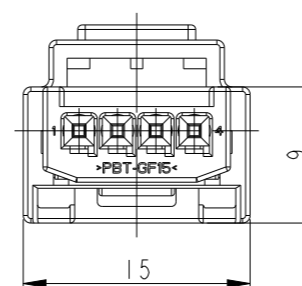
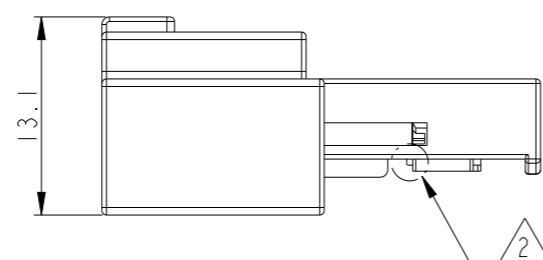
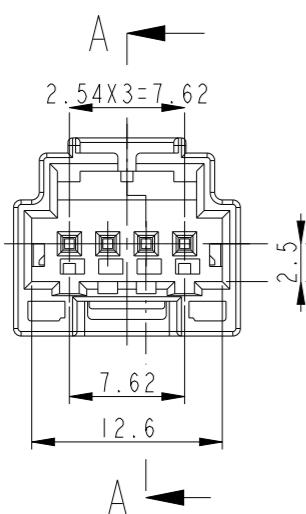

勝特力電材超市-龍山店 886-3-5773766  
 勝特力電材超市-光復店 886-3-5729570  
 勝特力電子(上海) 86-21-34970699  
 勝特力電子(深圳) 86-755-83298787  
<http://www.100y.com.tw>

NO.	COLOR	MATERIAL	DESCRIPTION	P/N	REV.	QTY
ⓑ	2	WHITE	PBT-GF15	DBL HSG	936123-1	1
	1	YELLOW	PBT-GF15	CAP HSG	936122-2	1
	1	BLACK	PBT-GF15	CAP HSG	936122-1	1

THIS DRAWING IS A CONTROLLED DOCUMENT.		DWN KT JUNG		TE Connectivity	
DIMENSIONS: MM		CHK JW JUNG			
TOLERANCES UNLESS OTHERWISE SPECIFIED:		APVD HG CHO		NAME MQS 4P CAP ASSEMBLY	
0 PLC ± 1 PLC ± 2 PLC ± 3 PLC ± 4 PLC ± ANGLES ± FINISH ±		PRODUCT SPEC -		APPLICATION SPEC -	
MATERIAL SEE TABLE		WEIGHT -		RESTRICTED TO -	
		CUSTOMER DRAWING		SCALE 2:1	
		SIZE A3		CAGE CODE 00779	
		DRAWING NO. C-936121		SHEET 1 OF 1	
				REV BI	



The product described in this document has not been fully tested to ensure conformance to the requirements outlined below. Therefore, TE Connectivity (TE) makes no representation or warranty, express or implied, that the product will comply with these requirements. Further, TE may change these requirements based on the results of additional testing and evaluation. Contact TE Engineering for further details.

### MQS 4P

#### 1. SCOPE

##### 1.1. Content

This specification covers the requirements for product performance, test methods and quality assurance provisions of MQS 4P

##### 1.2. Qualification

When tests are performed on the subject product line, procedures specified in Figure 1 shall be used. All inspections shall be performed using the applicable inspection plan and product drawing.

##### 1.3. Qualification Test Results

Successful qualification testing on the subject product line has not been completed. The Qualification Test Report number will be issued upon successful qualification testing.

#### 2. APPLICABLE DOCUMENTS AND FORMS

The following documents and forms constitute a part of this specification to the extent specified herein. Unless otherwise indicated, the latest edition of the document applies.

##### 2.1. TE Documents

- 936199 : CUSTOMER DRAWING FOR MQS 4P PLUG ASSY
- 936122 : CUSTOMER DRAWING FOR MQS 4P CAP ASSY
- 936399 : CUSTOMER DRAWING FOR MQS 4P CAP ASSY ( VERTICAL TYPE )

#### 3. REQUIREMENTS

##### 3.1. Design and Construction

Product shall be of the design, construction, materials and physical dimensions specified on the applicable product drawing.

##### 3.2. Ratings

Voltage	Temperature	Humidity
12V DC	25±5°C	60±20%

### 3.3. Test Requirements and Procedures Summary

Unless otherwise specified, all tests shall be performed at ambient environmental conditions.

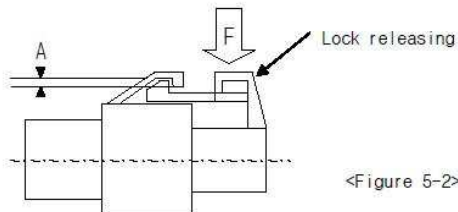
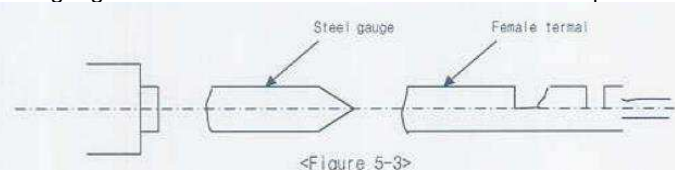
TEST DESCRIPTION	REQUIREMENT		PROCEDURE
Appearance	No crack, damage, distortion are permitted		Using sense of sight and touch.
CONN engage and disengage force	Max. 10 kgf and less		Measure force by inserting and disengaging the connector with terminal assembled at constant 100 mm/min speed. However, remove lock part when measuring disengage force.
Reverse insertion between housings	It shall not be incorrectly inserted by applying force of 20kgf.		Insert the housing with terminal by pushing it in reverse direction with applying 20kgf.
Reverse insertion between terminal and HSG	It shall not be incorrectly inserted by applying force of 5kgf.		Crimp cable of maximum size on terminal and then insert it into housing by end of insulation barrel in the reserve direction with applying 5kgf..
Insertion force between terminal and HSG	Max. 1.5kgf		Insert terminal into fixed HSG at 100mm/min speed
Strength of HSG lock	Min. 8kgf		Combine housing only, fix the one side of housing in completely locked condition, and extend the other side in axial direction at a constant speed of 100mm/min. Then measure weight when lock structure is disengaged or destroyed.
HSG lock releasing force	Max. 6kgf		Apply force (F) to lock releasing part, and measure weight on the point of A=0. However, cut connector and then perform test at the section in order to secure visibility. 
Terminal retention force	Min. 6kgf		Fix the housing after inserting crimped terminals. Extend one line of cable in axial direction at a speed of 50mm/min at a position 50~100mm away from crimped part, and measure weight when terminal is disengaged from the housing.
Engage and disengage force of terminal	Engage force	0.1~0.5kgf	As shown in figure 5-3, engage and disengage male terminal or steel gauge into or from female terminal at 100mm/min speed 
	Disengage force	0.1~0.5kgf	
Crimp strength	0.5SQ: Min. 9kgf		Fix the crimped terminal and draw the cable at a position 50~100mm away from crimped part in axial direction at 100mm/min speed. Then measure the weight when cable is cut or disengage from the crimped part.

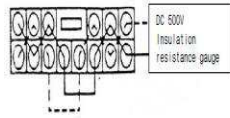
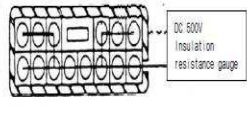
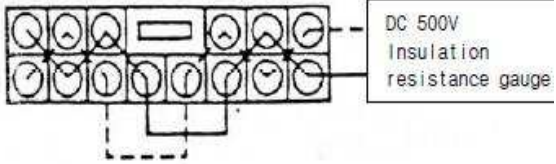
Voltage Drop	Max. 10mV/A		<p>Measure the circuit voltage drop (V) by sending voltage and current described in the table 5-1 with terminal combined on the connector. Then calculate a voltage drop (VD) in terminal by subtracting cable resistance (L) from the circuit voltage drop (V).</p> <p>1)HARNES versus UNIT:VD =V-(L3+L4 )</p> <table border="1"> <thead> <tr> <th>Application</th> <th>Open voltage</th> <th>Short circuit current</th> <th>Division</th> </tr> </thead> <tbody> <tr> <td>Signal circuit</td> <td>20 ± 5 mV</td> <td>10 mA</td> <td>ECU, Sensor</td> </tr> <tr> <td>Power circuit</td> <td>13 V</td> <td>1 A</td> <td>Other than the above</td> </tr> </tbody> </table> <p style="text-align: right;">&lt;Table5-1&gt;</p>	Application	Open voltage	Short circuit current	Division	Signal circuit	20 ± 5 mV	10 mA	ECU, Sensor	Power circuit	13 V	1 A	Other than the above
			Application	Open voltage	Short circuit current	Division									
Signal circuit	20 ± 5 mV	10 mA	ECU, Sensor												
Power circuit	13 V	1 A	Other than the above												
Insulation resistance	Min. 100 MΩ		<p>Measure resistance between neighbor terminals (figure 5-6), and between terminal and housing surface (figure 5-7) with DC 500V insulation resistance gauge with connector combined.</p> <div style="display: flex; justify-content: space-around;">   </div> <p style="text-align: center;">&lt;Figure 5-6: Between neighboring terminals&gt;    &lt;Figure 5-7: Between neighboring terminal and housing surface&gt;</p>												
Leakage current	10 μA or less		<p>Measure it by applying DC 13V between neighboring terminals (figure 5-6).</p>  <p style="text-align: center;">&lt;Figure 5-6: Between neighboring terminals&gt;</p>												
High voltage test	No allowed Insulation breakdown		Measured by applying test potential of 1000 V AC for 1 minutes between the adjacent contact between the contact and housing.												
Temperature rise	Max. 30 °C		Apply basic current (I=10*K) of clause 4.3 to the connector with electrodes in series in the room free from wind (normal temperature). And measure a temperature of crimped part after reaching saturation temperature. Then calculate a temperature of crimped part by subtracting ambient temperature from the temperature.												
Twisting Test - Connector Engage and Disengage Endurance Test	Appearance	No crack, damage, distortion are permitted	Apply 8kgf force on the end part of combined connector 10 times each in the (front, rear, left, right) directions perpendicular to axial direction.  Make combine connectors engage and disengage at 100mm/min. Perform it 50 times. (Do not use locking device)												
	Voltage drop	Max. 20mV/A													
Overcurrent cycle test	Appearance	No crack, damage, distortion are permitted													
	Voltage drop	Max. 20mV/A	Condition A(8.8A)												
			Condition B(22A)												
Temperature rise	Max. 40°C	Condition A(8.8A)													
		Condition B(22A)	<table border="1"> <tbody> <tr> <td rowspan="2">Current application condition A</td> <td>Applied current</td> <td>2 times of basic current</td> </tr> <tr> <td>Current application time</td> <td>1 minute - ON, 9 minutes - OFF</td> </tr> <tr> <td rowspan="2">Current application condition B</td> <td>Applied current</td> <td>5 times of basic current</td> </tr> <tr> <td>Current application time</td> <td>10 seconds - ON, 590 seconds - OFF</td> </tr> </tbody> </table>	Current application condition A	Applied current	2 times of basic current	Current application time	1 minute - ON, 9 minutes - OFF	Current application condition B	Applied current	5 times of basic current	Current application time	10 seconds - ON, 590 seconds - OFF		
Current application condition A	Applied current	2 times of basic current													
	Current application time	1 minute - ON, 9 minutes - OFF													
Current application condition B	Applied current	5 times of basic current													
	Current application time	10 seconds - ON, 590 seconds - OFF													

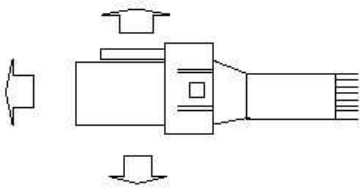
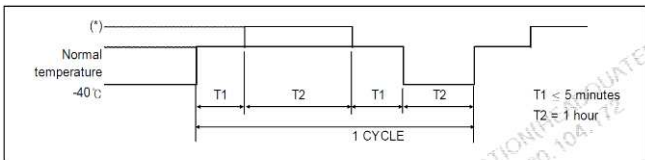
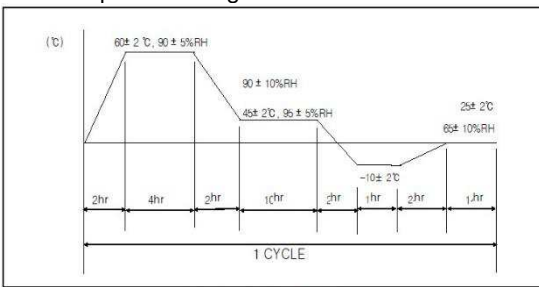
Cold temperature test	Appearance	No crack, damage, distortion are permitted		Engage and disengage connector with terminal assembled 10 times with hands, and leave it in temperature chamber of $-40^{\circ}\text{C}$ for 120 hours. Make connector engaged and disengaged 5 times immediately, and drop it onto the concrete surface from 1m height 3 times in the direction of figure 6-1. (Voltage drop & Temperature rise test perform at normal temperature) : 									
	Voltage drop	Max. 10mV/A											
	Insulation resistance	Non-Sealed CONN'R :	Between terminals		<Figure 6-1>								
		Min. 100 MΩ	housing surface										
	Current leakage	Max. 1mA											
Temperature rise	Max. 60°C												
Cold and hot temperature shock test	Appearance	No crack, damage, distortion are permitted		Engage and disengage connector with terminal assembled 10 times with hands, and leave it in combined state at $-40^{\circ}\text{C}$ for 2 hours, and perform 200 cycles according of the method specified in the figure 6-2. Then leave it at room temperature for 2 hours or more (*) follows table 6-1) 									
	Voltage drop	Max. 20mV/A											
				< Figure 6- 2 : Test pattern > <table border="1"> <thead> <tr> <th>Division</th> <th>High temperature (*)</th> <th>Connector using part</th> </tr> </thead> <tbody> <tr> <td>A</td> <td>120 °C</td> <td>waterproof connector</td> </tr> <tr> <td>B</td> <td>80 °C</td> <td>Non- waterproof connector</td> </tr> </tbody> </table>	Division	High temperature (*)	Connector using part	A	120 °C	waterproof connector	B	80 °C	Non- waterproof connector
Division	High temperature (*)	Connector using part											
A	120 °C	waterproof connector											
B	80 °C	Non- waterproof connector											
				< Table 6- 1 >									
High temperature test	Appearance	No crack, damage, distortion are permitted		Engage and disengage connector with terminal assembled 10 times with hands, and leave it in combined state at the temperature chamber of the table 6-1 for 300 hours. Then pick it out and leave it until it returns to normal temperature. <table border="1"> <thead> <tr> <th>High temperature(+)</th> <th>Connector using part</th> </tr> </thead> <tbody> <tr> <td>80°C</td> <td>Non-waterproof connector</td> </tr> </tbody> </table>	High temperature(+)	Connector using part	80°C	Non-waterproof connector					
	High temperature(+)	Connector using part											
80°C	Non-waterproof connector												
Voltage drop	Max. 20mV/A												
Temperature Humidity Test	Appearance	No crack, damage, distortion are permitted		Engage and disengage connector with terminal assembled 10 times with hands, and leave it at $25^{\circ}\text{C}$ ambient temperature and 65% relative humidity for 25 hours. And perform 5 cycles of the method specified in figure 6-3 									
	Voltage drop	Max. 20mV/A											
	Current leakage	Non-waterproof connector Max. 1 mA											
				< Figure 6-3 : Test pattern >									

Dust test	Voltage drop	Max. 20mV/A	Engage and disengage connector with terminal assembled 10 times with hands, and diffuse 1.5kg Portland cement(JIS R5210) with fan (or others) for 10 seconds per 15 minutes while maintaining 150mm distance from wall in the closed container of 900~1200mm length, width and height, with connector combined. After 1 hour, measure it.
Oil and liquid test	Appearance	No crack, damage, distortion are permitted	Engage and disengage connector with terminal assembled 10 times with hands, and perform test each sample with connector combined. A. Immerse connector in combined state for 2 hours in mixed oil of 50± 2°C ENG oil (SAE10W) or equivalent oil and B. Immerse connector in combined state for 1 hour in car gasoline (JIS K2202) at normal temperature, and then pick it out. C. Immerse connector in combined state for 1 hour in brake liquid (pure product) at normal temperature, and then pick it out. D. Immerse connector in combined state for 1 hour in 100% washer liquid (pure product) at normal temperature, and then pick it out. E. Immerse connector in combined state for 1 hour in 50% LLC (Long life coolant) at normal temperature, and then pick it out.
	Voltage drop	Max. 20mV/A	
Ozone test	Appearance	No crack, damage, distortion are permitted	Engage and disengage Connector with terminal assembled 10 times with hands, and samples keep at 40°C and 50±5pphm Ozone for 100hour. Then pick connector out of chamber and dry it for 2hours or more.
	Voltage drop	Max. 10mV/A	
Sulfur (SO <sub>2</sub> ) gas test	Appearance	No crack, damage, distortion are permitted	Engage and disengage connector with terminal assembled 10 times with hands, and expose it in combined state to sulfur gas of 40±3°C, density 10ppm, humidity 90~95%, for 24 hours. Then pick connector out of chamber and dry it for 2 hours or more.
	Voltage Drop	Max. 20mV/A	
Complex environment endurance test	Appearance	No crack, damage, distortion are permitted	Engage and disengage connector with terminal assembled 10 times with hands, and leave it in combined state in the temperature chamber of 80°C for 48 hours. And then perform the following vibration test. Then measure instant short circuit according to the method of below for 4 hours for X, Y, Z each. Follow figure 6-7 for connector attaching method.
	Crimp tensile strength	Min. 9kgf (0.5SQ)	
	Voltage drop	Max. 20mV/A	
	Temperature rise	Max. 60°C	
	Instant short circuit	Max 10μs	

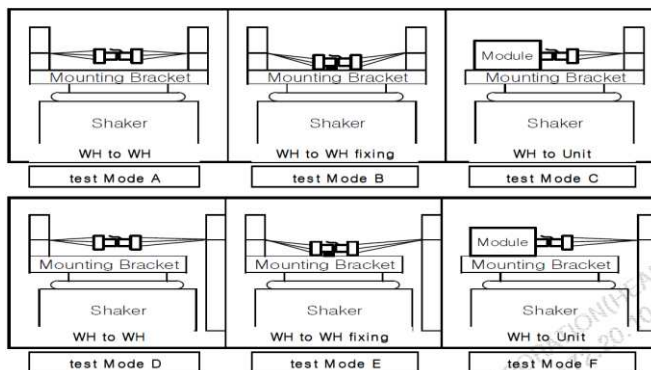

<Figure 6-7 Connector attaching method>

■ Vibration test A (for non-waterproof connector)

Division	Condition
Ambient temperature/humidity	80°C, 90~95%
Applied current	Basic current (Connector electrodes in series.)
Current application cycle	120 CYCLE (45 minutes-ON, 15 minutes-OFF)
Vibration acceleration	4.4g
Frequency	20Hz ~ 200Hz (sweep time: 3 minutes or less)
Vibration time	40 hours for X, Y, Z each
Connector attaching method	Test mode A, B, C

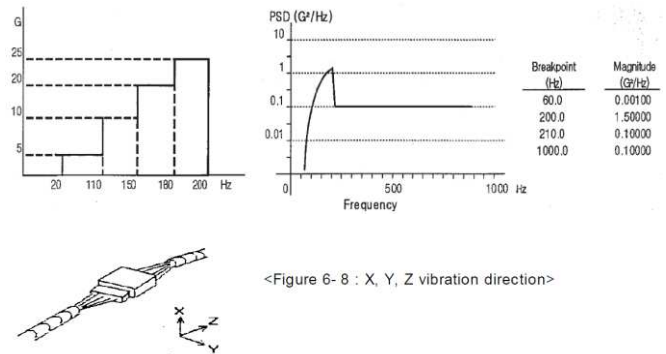

3.4. Applied Part No List

TE Part no	Description
936119-1	MQS 4P PLUG ASSY BLACK
936119-2	MQS 4P PLUG ASSY YELLOW
936119-3	MQS 4P PLUG ASSY DARK GRAY
936119-6	MQS 4P PLUG ASSY BLUE
1-936119-1	MQS 4P PLUG ASSY WITH CPA BLACK
1-936119-2	MQS 4P PLUG ASSY WITH CPA YELLOW
1-936119-3	MQS 4P PLUG ASSY WITH CPA DARK GRAY
1-936119-6	MQS 4P PLUG ASSY WITH CPA BLUE
936121-1	MQS 4P CAP ASSY BLACK
936121-2	MQS 4P CAP ASSY YELLOW
936399-1	MQS 4P CAP ASSY(VERTICAL TYPE) NATURAL
936399-2	MQS 4P CAP ASSY(VERTICAL TYPE) BLACK
1-936399-3	MQS 4P CAP ASSY(VERTICAL TYPE) DARK GRAY
936399-5	MQS 4P CAP ASSY(VERTICAL TYPE) YELLOW