

P	LTR	DESCRIPTION	DATE	DWN	APVD
	D3	REVISED (ECR-16-009804)	07JUL2016	JM	JW
	D4	REVISED (ECR-17-000376)	10JAN2017	JM	JW
	D5	REVISED (ECR-17-014365)	28SEP2017	HH	YJ
	D6	REVISED (ECR-22-150596)	26AUG2022	DG	YJ

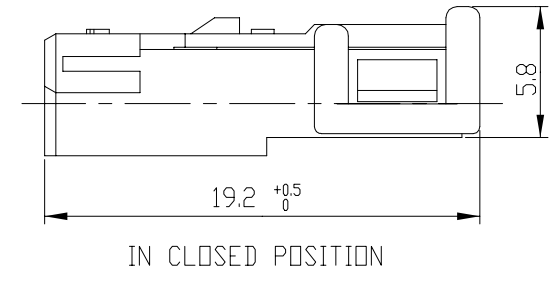

勝特力電材超市-龍山店 886-3-5773766  
 勝特力電材超市-光復店 886-3-5729570  
 勝特力電子(上海) 86-21-34970699  
 勝特力電子(深圳) 86-755-83298787  
<http://www.100y.com.tw>

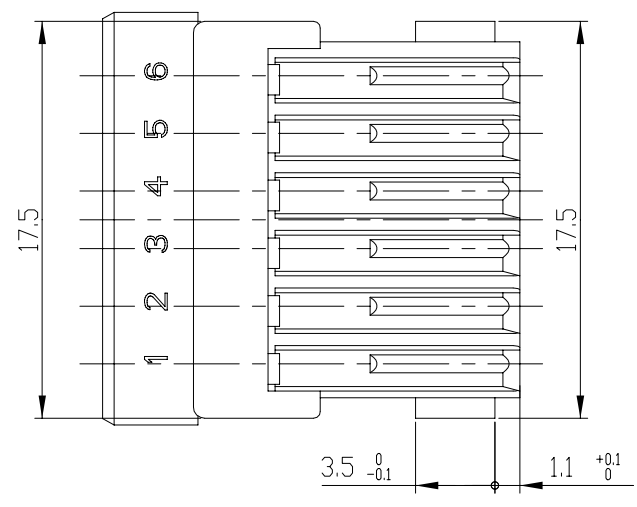
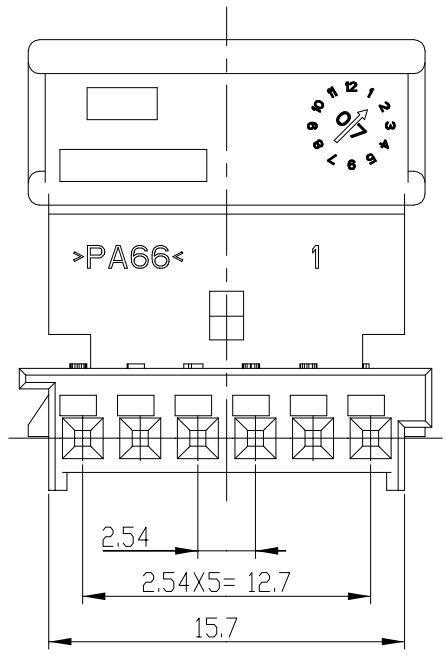
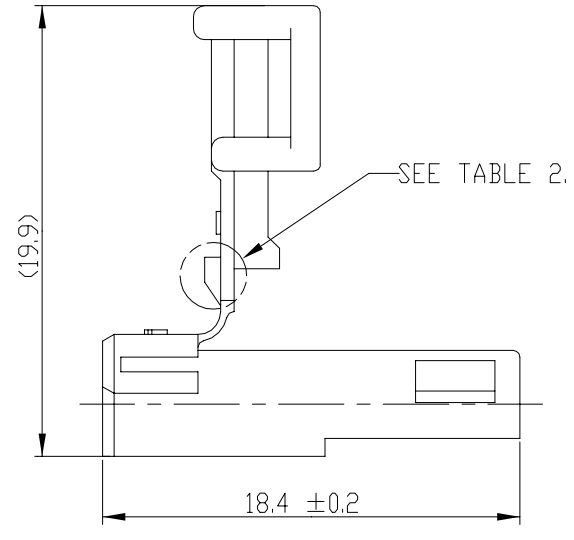

(TABLE 1) SCALE 2:1

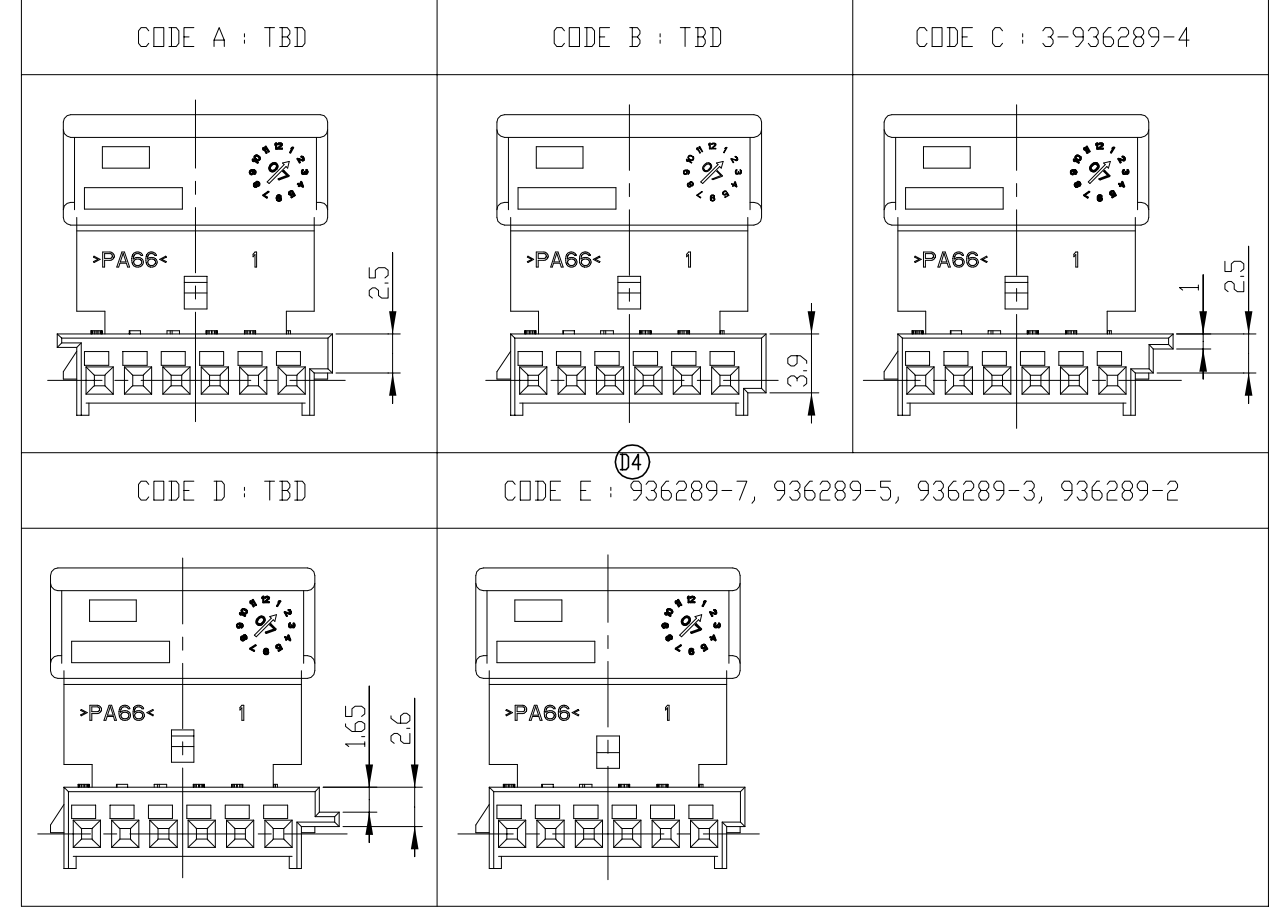

	936289-5 936289-2 936289-3 (D4) 936289-7 3-936289-4

NO.	CODE	COLOR	MATERIAL	DESCRIPTION	PART NO.
D4 1	E	GRAY	PA66	SOCKET HSG 6P	5 936289-3
	E	BLACK	PA66	SOCKET HSG 6P	5 936289-2
	E	NATURAL	PBT	SOCKET HSG 6P	4 936289-5
	E	GREEN	PA66	SOCKET HSG 6P	5 936289-7
	D	-	PBT	SOCKET HSG 6P	TBD
	C	BROWN	PA66	SOCKET HSG 6P	5 3-936289-4
	B	-	PBT	SOCKET HSG 6P	TBD
	A	-	PBT	SOCKET HSG 6P	TBD

- NOTE
- BE MATED WITH HEADER HSG (P/N : 936287) SMOOTHLY
  - CODE IS AS FOLLOWS: SEE TABLE 1.
  - APPLICABLE RECEPTACLE CONTACT P/N

PART NO.	DESCRIPTION	WIRE SIZE(mm <sup>2</sup> )
5-928999-X	MQS RECEPTACLE TML (SOCKET CONTACT)	0.2 ~ 0.5
5-963715-X	MQS RECEPTACLE TML (SOCKET CONTACT)	0.75

- MQS CONTACT(AVX: 0.5mm<sup>2</sup> / AVSS-X: 0.75mm<sup>2</sup>)
- △ LOCKING FORCE : MIN 4kgf (FORCE WITH FULL PINS APPLIED, ONLY EXPORT)
- △ LOCKING FORCE : OVER 8kgf
- 6. GENERAL TOLERANCE

GENERAL TOLERANCES	
10 MAX	±0.3
10 OVER 30 MAX	±0.2
30 OVER 100 MAX	±0.25
ANGLES	±3°

(D5)

THIS DRAWING IS A CONTROLLED DOCUMENT.

DIMENSIONS:	TOLERANCES UNLESS OTHERWISE SPECIFIED
mm	0 PLC ±
	1 PLC ±
	2 PLC ±
	3 PLC ±
	4 PLC ±
	ANGLES ±
MATERIAL	FINISH -

SEE TABLE

DWN	JM JEON
CHK	-
APVD	JW JUNG
PRODUCT SPEC	-
APPLICATION SPEC	-
WEIGHT	-

		NAME	
		MQS. SOCKET HOUSING 6POS	
SIZE	CAGE CODE	DRAWING NO	RESTRICTED TO
A3	00779	©-936289	-
CUSTOMER DRAWING		SCALE 3:1	SHEET 1 OF 1 REV D6



The product described in this document has not been fully tested to ensure conformance to the requirements outlined below. Therefore, TE Connectivity (TE) makes no representation or warranty, express or implied, that the product will comply with these requirements. Further, TE may change these requirements based on the results of additional testing and evaluation. Contact TE Engineering for further details.

### MQS PLUG/HEADER ASSEMBLY

#### 1. SCOPE

##### 1.1. Content

This specification covers the requirements for product performance, test methods and quality assurance provisions of MQS Plug/Header Assembly

##### 1.2. Qualification

When tests are performed on the subject product line, procedures specified in Figure 1 shall be used. All inspections shall be performed using the applicable inspection plan and product drawing.

##### 1.3. Qualification Test Results

Successful qualification testing on the subject product line has not been completed. The Qualification Test Report number will be issued upon successful qualification testing.

#### 2. APPLICABLE DOCUMENTS AND FORMS

The following documents and forms constitute a part of this specification to the extent specified herein. Unless otherwise indicated, the latest edition of the document applies.

##### 2.1. TE Documents

- 1743282: Customer Drawing (MQS 8P PLUG HSG)
- 1743283: Customer Drawing (MQS 8P PLUG DBL)
- 1743284: Customer Drawing (MQS 8P HEADER ASSEMBLY H-TYPE)
- 1743386: Customer Drawing (MQS 8P HEADER ASSEMBLY V-TYPE)
- 936289: Customer Drawing (MQS 6P PLUG HSG)
- 936640: Customer Drawing (MQS 6P HEADER ASSEMBLY V-TYPE)
- 936119: Customer Drawing (MQS 4P PLUG ASSEMBLY)
- 1743218: Customer Drawing (MQS 4P HEADER ASSEMBLY)
- 1743164: Customer Drawing (MQS 3P PLUG HSG)

#### 3. REQUIREMENTS

##### 3.1. Design and Construction

Product shall be of the design, construction, materials and physical dimensions specified on the applicable product drawing.

##### 3.2. Ratings

Voltage	Temperature	Humidity
12V DC	25±5°C	60±20%

##### 3.3. Test Requirements and Procedures Summary

Unless otherwise specified, all tests shall be performed at ambient environmental conditions.

## 3.3.1 ES91500-00 (MQS 8P / 4P /3P)

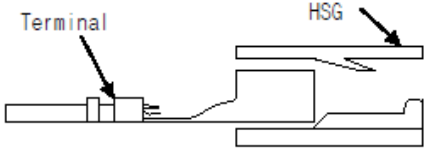
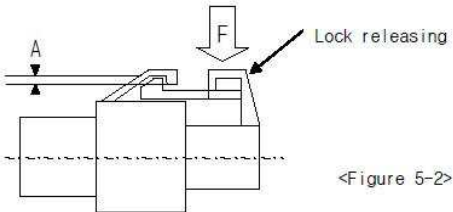
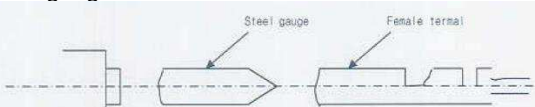
TEST DESCRIPTION	REQUIREMENT	PROCEDURE
Appearance	No crack, damage, distortion are permitted	Using sense of sight and touch.
CONN engage and disengage force	Max 10kgf	Measure force by inserting and disengaging the connector with terminal assembled at constant 50 mm/min speed. However, remove lock part when measuring disengage force.
Reverse insertion between housings	It shall not be incorrectly inserted by applying force of 20kgf.	Insert the housing with terminal by pushing it in reverse direction with applying 20kgf.
Reverse insertion between terminal and housing	It shall not be incorrectly inserted b applying force of 5kgf.	Crimp cable of maximum size on terminal and then insert it into housing by applying force of 5kfg in the reserve direction.
Engage force between terminal and housing	Max 1.5kgf	As shown in the following figure 5-1, measure the weight while inserting terminal into fixed housing at 50mm/min speed.  < Figure 5-1>
Contact to HSG Inverse Force	Min 1.5kgf	Crimp cable of maximum size on terminal and then insert it into housing by end of insulation barrel in the reserve direction.
Strength of HSG lock	Min 8kgf	Combine housing only, fix the one side of housing in completely locked condition, and extend the other side in axial direction at a constant speed of 100mm/min. Then measure weight when lock structure is disengaged or destroyed.
HSG lock releasing force	Max 6kgf	Apply force (F) to lock releasing part, and measure weight on the point of A=0. However, cut connector and then perform test at the section in order to secure visibility.  <Figure 5-2>
Terminal retention force	1) Min 6kgf 2) Min 5kgf (Only MQS 4P)	Fix the housing after inserting crimped terminals. Extend one line of cable in axial direction at a speed of 50mm/min at a position 50~100mm away from crimped part, and measure weight when terminal is disengaged from the housing.
Engage and disengage force of terminal	Engage: 0.1~0.5kgf Disengage: 0.1~0.5kgf	As shown in figure 5-3, engage and disengage male terminal or steel gauge into or from female terminal at 100mm/min speed  <Figure 5-3>

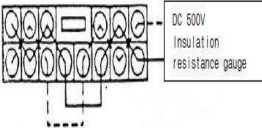
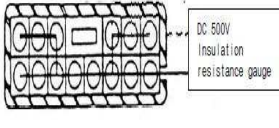
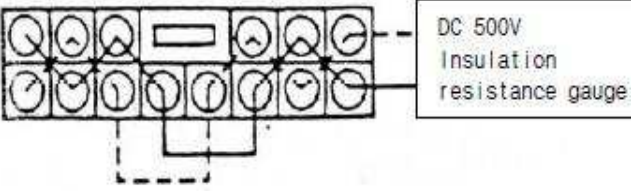
Crimp strength	0.5SQ: Min 9kgf		Fix the crimped terminal and draw the cable at a position 50~100mm away from crimped part in axial direction at 100mm/min speed. Then measure the weight when cable is cut or disengage from the crimped part.												
Voltage Drop	Max 10mV/A		Measure the circuit voltage drop (V) by sending voltage and current described in the table -1 with terminal combined on the connector. Then calculate a voltage drop (VD) in terminal by subtracting cable resistance (L) from the circuit voltage drop (V). 1) HARNESS versus UNIT: $VD = V - (L3+L4)$ <table border="1" data-bbox="776 478 1349 604"> <thead> <tr> <th>Application</th> <th>Open voltage</th> <th>Short circuit current</th> <th>Division</th> </tr> </thead> <tbody> <tr> <td>Signal circuit</td> <td><math>20 \pm 5 \text{ mV}</math></td> <td>10 mA</td> <td>ECU, Sensor</td> </tr> <tr> <td>Power circuit</td> <td>13 V</td> <td>1 A</td> <td>Other than the above</td> </tr> </tbody> </table> <p style="text-align: center;">&lt;Table5-1&gt;</p>	Application	Open voltage	Short circuit current	Division	Signal circuit	$20 \pm 5 \text{ mV}$	10 mA	ECU, Sensor	Power circuit	13 V	1 A	Other than the above
Application	Open voltage	Short circuit current	Division												
Signal circuit	$20 \pm 5 \text{ mV}$	10 mA	ECU, Sensor												
Power circuit	13 V	1 A	Other than the above												
Insulation resistance	Min 100 MΩ		Measure resistance between neighbor terminals (figure 5-6), and between terminal and housing surface (figure 5-7) with DC 500V insulation resistance gauge with connector combined. <div style="display: flex; justify-content: space-around; align-items: center;">   </div> <p style="font-size: small; text-align: center;">&lt;Figure 5-6: Between neighboring terminals&gt;    &lt;Figure 5-7: Between neighboring terminal and housing surface&gt;</p>												
Leakage current	10 μA or less		Measure it by applying DC 13V between neighboring terminals (figure 5-6). <div style="text-align: center;">  </div> <p style="text-align: center;">&lt;Figure 5-6: Between neighboring terminals&gt;</p>												
High voltage test	There shall be no insulation break		Apply AC 1000V voltage of normal frequency 1 minute between neighboring terminals, and between housing surfaces of terminal, with connector combined.												
Temperature rise	General Connector Max 30 °C		Apply basic current ( $I=I_0 \cdot K$ ) of clause 4.3 to the connector with electrodes in series in the room free from wind (normal temperature). And measure a temperature of crimped part after reaching saturation temperature. Then calculate a temperature of crimped part by subtracting ambient temperature from the temperature.												
Twisting Test Connector Engage and Disengage Endurance Test	Appearance	No crack, damage, distortion are permitted	Apply 8kgf force on the end part of combined connector 10 times each in the (front, rear, left, right) directions perpendicular to axial direction.												
	1) Max 10mV/A 2) Max 20mV/A (Only MQS 4P)		Make combine connectors engage and disengage at 100mm/min. Perform it 50 times. (Do not use locking device)												

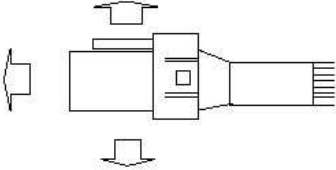
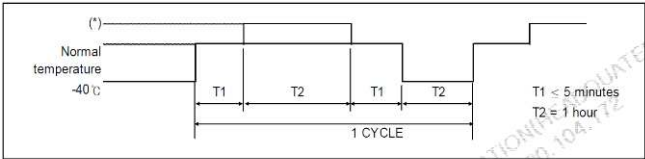
Overcurrent cycle test	Appearance	No crack, damage, distortion are permitted		Engage and disengage connector with terminal assembled 10 times with hands, and apply to following current 1000 cycles for the connector with electrodes in series at 60°C of ambient temperature. <table border="1" style="margin-top: 10px;"> <tr> <td rowspan="2">Current application condition A</td> <td>Applied current</td> <td>2 times of basic current</td> </tr> <tr> <td>Current application time</td> <td>1 minute - ON, 9 minutes - OFF</td> </tr> <tr> <td rowspan="2">Current application condition B</td> <td>Applied current</td> <td>5 times of basic current</td> </tr> <tr> <td>Current application time</td> <td>10 seconds - ON, 590 seconds - OFF</td> </tr> </table>	Current application condition A	Applied current	2 times of basic current	Current application time	1 minute - ON, 9 minutes - OFF	Current application condition B	Applied current	5 times of basic current	Current application time	10 seconds - ON, 590 seconds - OFF
	Current application condition A	Applied current	2 times of basic current											
		Current application time	1 minute - ON, 9 minutes - OFF											
Current application condition B	Applied current	5 times of basic current												
	Current application time	10 seconds - ON, 590 seconds - OFF												
Voltage Drop	1) Max 10mV/A 2) Max 20mV/A (Only MGS 4P)	Condition A(8.8A) Condition B(22A)												
Temperature Rise	Max 40 °C	Condition A(8.8A) Condition B(22A)												
Cold temperature test	Appearance	No crack, damage, distortion are permitted		Engage and disengage connector with terminal assembled 10 times with hands, and leave it in temperature chamber of -40°C for 120 hours. Make connector engaged and disengaged 5 times immediately, and drop it onto the concrete surface from 1m height 3 times in the direction of figure 6-1. (Voltage drop & Temperature rise test perform at normal temperature) : <div style="text-align: center; margin-top: 10px;">  <p>&lt;Figure 6-1&gt;</p> </div>										
	Insulation Resistance	Non-waterproof connector Min 10 kΩ												
	Current Leakage	Non-waterproof connector Max 1 mA												
Cold and hot temperature shock test	Appearance	No crack, damage, distortion are permitted		Engage and disengage connector with terminal assembled 10 times with hands, and leave it in combined state at -40°C for 2 hours, and perform 200 cycles according of the method specified in the figure 6-2. Then leave it at room temperature for 2 hours or more (*) follows table 6-1) <div style="text-align: center; margin-top: 10px;">  <p>&lt; Figure 6- 2 : Test pattern &gt;</p> <table border="1" style="margin-top: 5px;"> <thead> <tr> <th>Division</th> <th>High temperature (*)</th> <th>Connector using part</th> </tr> </thead> <tbody> <tr> <td>A</td> <td>120 °C</td> <td>waterproof connector</td> </tr> <tr> <td>B</td> <td>80 °C</td> <td>Non- waterproof connector</td> </tr> </tbody> </table> <p>&lt; Table 6- 1 &gt;</p> </div>	Division	High temperature (*)	Connector using part	A	120 °C	waterproof connector	B	80 °C	Non- waterproof connector	
	Division	High temperature (*)	Connector using part											
A	120 °C	waterproof connector												
B	80 °C	Non- waterproof connector												
Voltage Drop	1) Max 10mV/A 2) Max 20mV/A (Only MGS 4P)													
High temperature test	Appearance	No crack, damage, distortion are permitted		Engage and disengage connector with terminal assembled 10 times with hands, and leave it in combined state at the temperature chamber of the table 6-1 for 300 hours. Then pick it out and leave it until it returns to normal temperature. <table border="1" style="margin-top: 10px; width: 100%;"> <tr> <td>High temperature(*)</td> <td>Connector using part</td> </tr> <tr> <td>80°C</td> <td>Non-waterproof connector</td> </tr> </table>	High temperature(*)	Connector using part	80°C	Non-waterproof connector						
	High temperature(*)	Connector using part												
80°C	Non-waterproof connector													
Voltage Drop	1) Max 10mV/A 2) Max 20mV/A (Only MGS 4P)													
Soldering test	Appearance	Satisfied an appearance quality and apply 95% or more		Deposit the soldering part of TM'L post coming out of connector in the solder deposition tank at 250±5 °C or less seconds. Deposition depth is up to 1.5mm from connector main body										

Temperature Humidity Test	Appearance	No crack, damage, distortion are permitted	Engage and disengage connector with terminal assembled 10 times with hands, and leave it at 25°C ambient temperature and 65% relative humidity for 25 hours. And perform 5 cycles of the method specified in figure 6-3. Then pick connector out of chamber and dry it for 2 hours or more.  < Figure 6-3 : Test pattern >
	Voltage Drop	1) Max 10mV/A 2) Max 20mV/A (Only MQS 4P)	
	Insulation Resistance	Non-waterproof connector Min 10 kΩ	
	Current Leakage	Non-waterproof connector Max 1 mA	
Dust Test	Voltage Drop	1) Max 10mV/A 2) Max 20mV/A (Only MQS 4P)	Engage and disengage connector with terminal assembled 10 times with hands, and diffuse 1.5kg Portland cement (JIS R5210) with fan (or others) for 10 seconds per 15 minutes while maintaining 150mm distance from wall in the closed container of 900~1200mm length, width and height, with connector combined. After 1 hour, measure it.
Oil and liquid test	Appearance	No crack, damage, distortion are permitted	Engage and disengage connector with terminal assembled 10 times with hands, and perform test each sample with connector combined. A. Immerse connector in combined state for 2 hours in mixed oil of 50± 2°C ENG oil (SAE10W) or equivalent oil and B. Immerse connector in combined state for 1 hour in car gasoline (JIS K2202) at normal temperature, and then pick it out. C. Immerse connector in combined state for 1 hour in brake liquid (pure product) at normal temperature, and then pick it out. D. Immerse connector in combined state for 1 hour in 100% washer liquid (pure product) at normal temperature, and then pick it out. E. Immerse connector in combined state for 1 hour in 50% LLC (Long life coolant) at normal temperature, and then pick it out.
	Voltage Drop	1) Max 10mV/A 2) Max 20mV/A (Only MQS 4P)	
Ozone Test (Only MQS 4P)	Appearance	No crack, damage, distortion are permitted	Engage and disengage Connector with terminal assembled 10 times with hands, and samples keep at 40°C and 50±5pphm Ozone for 100hour. Then pick connector out of chamber and dry it for 2hours or more.
	Voltage Drop	Max 20mV/A	
	Sealing	Min 0.5kgf/cm <sup>2</sup>	
Sulfur (SO <sub>2</sub> ) gas test	Appearance	No crack, damage, distortion are permitted	Engage and disengage connector with terminal assembled 10 times with hands, and expose it in combined state to sulfur gas of 40±3°C, density 10ppm, humidity 90~95%, for 24 hours. Then pick connector out of chamber and dry it for 2 hours or more.
	Voltage Drop	1) Max 10mV/A 2) Max 20mV/A (Only MQS 4P)	



Complex environment endurance test	Appearance	No crack, damage, distortion are permitted	Engage and disengage connector with terminal assembled 10 times with hands, and leave it in combined state in the temperature chamber of 80°C for 48 hours. And then perform the following vibration test. Then measure instant short circuit according to the method of below for X, Y, Z each. Follow figure 6-7 for connector attaching method.																
	Crimp Tensile Strength	0.5SQ: Min 9kgf	<p style="text-align: center;">&lt;Figure 6-7 Connector attaching method&gt;</p>																
	Voltage Drop	1) Max 10mV/A 2) Max 20mV/A (Only MQS 4P)	<p>■ Vibration test A (for non-waterproof connector)</p> <table border="1" style="width: 100%; border-collapse: collapse;"> <thead> <tr> <th style="width: 50%;">Division</th> <th style="width: 50%;">Condition</th> </tr> </thead> <tbody> <tr> <td>Ambient temperature/humidity</td> <td>80°C, 90~95%</td> </tr> <tr> <td>Applied current</td> <td>Basic current (Connector electrodes in series.)</td> </tr> <tr> <td>Current application cycle</td> <td>120 CYCLE (45 minutes-ON, 15 minutes-OFF)</td> </tr> <tr> <td>Vibration acceleration</td> <td>4.4g</td> </tr> <tr> <td>Frequency</td> <td>20Hz ~ 200Hz (sweep time: 3 minutes or less)</td> </tr> <tr> <td>Vibration time</td> <td>40 hours for X, Y, Z each</td> </tr> <tr> <td>Connector attaching method</td> <td>Test mode A, B, C</td> </tr> </tbody> </table>	Division	Condition	Ambient temperature/humidity	80°C, 90~95%	Applied current	Basic current (Connector electrodes in series.)	Current application cycle	120 CYCLE (45 minutes-ON, 15 minutes-OFF)	Vibration acceleration	4.4g	Frequency	20Hz ~ 200Hz (sweep time: 3 minutes or less)	Vibration time	40 hours for X, Y, Z each	Connector attaching method	Test mode A, B, C
	Division	Condition																	
	Ambient temperature/humidity	80°C, 90~95%																	
	Applied current	Basic current (Connector electrodes in series.)																	
Current application cycle	120 CYCLE (45 minutes-ON, 15 minutes-OFF)																		
Vibration acceleration	4.4g																		
Frequency	20Hz ~ 200Hz (sweep time: 3 minutes or less)																		
Vibration time	40 hours for X, Y, Z each																		
Connector attaching method	Test mode A, B, C																		
Temperature Rise	General Connector Max 40°C (4.4A)																		
Instant short circuit	Max 10 $\mu$ s	<p style="text-align: right;">&lt;Figure 6-8 : X, Y, Z vibration direction&gt;</p>																	

## 3.3.2 ES91500-03 (MQS 6P)

TEST DESCRIPTION	REQUIREMENT	PROCEDURE
Appearance	No crack, damage, distortion are permitted	Using sense of sight and touch.
CONN engage and disengage force	1) Min 10kgf 2) Min 7.6kgf (Only MQS 6P)	Measure force by inserting and disengaging the connector with terminal assembled at constant 50 mm/min speed. However, remove lock part when measuring disengage force.

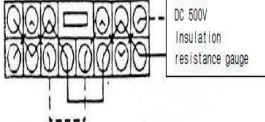
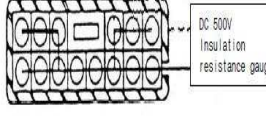
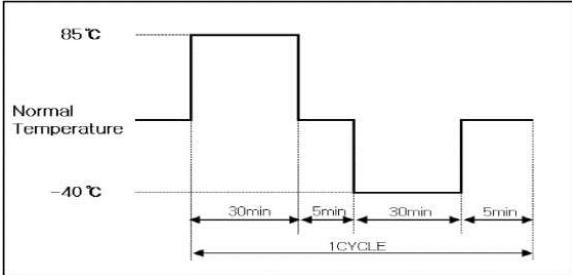
Reverse insertion between housings	It shall not be incorrectly inserted by applying force of 10kgf.	Insert the housing with terminal by pushing it in reverse direction with applying 10kgf.								
Strength of HSG lock	4P or more: Max 4kgf	Combine housing only, fix the one side of housing in completely locked condition, and extend the other side in axial direction and 30 angle direction at a constant speed of 50mm/min. Then measure weight when lock structure is disengaged or destroyed.								
Voltage Drop	Max 30mΩ	<p>Measure the circuit voltage drop (V) by sending voltage and current described in the table -1 with terminal combined on the connector. Then calculate a voltage drop (VD) in terminal by subtracting cable resistance (L) from the circuit voltage drop (V).</p> <p>HARNESS UNIT: <math>VD = V - (L1+L2)</math></p> <table border="1"> <thead> <tr> <th>Application</th> <th>Open voltage</th> <th>Short circuit current</th> <th>Division</th> </tr> </thead> <tbody> <tr> <td>Signal circuit</td> <td>20 ± 5 mV</td> <td>10 mA</td> <td>ECU, Sensor</td> </tr> </tbody> </table>	Application	Open voltage	Short circuit current	Division	Signal circuit	20 ± 5 mV	10 mA	ECU, Sensor
Application	Open voltage	Short circuit current	Division							
Signal circuit	20 ± 5 mV	10 mA	ECU, Sensor							
Insulation resistance	Min 100 MΩ	<p>Measure resistance between neighbor terminals (figure 5-6), and between terminal and housing surface (figure 5-7) with DC 500V insulation resistance gauge with connector combined.</p>   <p>&lt;Figure 5-6: Between neighboring terminals&gt; &lt;Figure 5-7: Between neighboring terminal and housing surface&gt;</p>								
High voltage test	There shall be no insulation break	Apply AC 500V voltage of normal frequency 1 minute between neighboring terminals, and between housing surfaces of terminal, with connector combined.								
Connector solderability	No crack, damage, distortion are permitted	<p>Fluxed soldering section of a specimen shall be dipped in solder of the following conditions.</p> <p>1) Sn / Pb conditions</p> <ul style="list-style-type: none"> <li>- Solder temperature : 230 +/-5°C</li> <li>- Immersion period : 3 +/-0.5sec</li> </ul> <p>2) Pb free conditions</p> <ul style="list-style-type: none"> <li>- Solder temperature : 245 +/-5°C</li> <li>- Immersion period : 3 +/-0.5sec</li> </ul>								
Cold and hot temperature shock test	Appearance	No crack, damage, distortion are permitted								
	Voltage Drop	Max 50mΩ								
High temperature test	Appearance	No crack, damage, distortion are permitted								
	Voltage Drop	Max 50mΩ								
<p>Engage and disengage connector 10 times by hand, and perform 200 cycles. Then pick specimen out of chamber and leave at room temperature for 2 hours or more</p> 										
<p>Engage and disengage connector 10 times by hand, and leave it in combined state at the temperature chamber of 85°C for 300 hours. Then pick specimen out of chamber and leave at room temperature for 2 hours or more.</p>										



High temperature and high humidity test	Appearance	No crack, damage, distortion are permitted	Leave assembled connector in chamber of $85\pm 2^{\circ}\text{C}$ temperature and 85% humidity for 500 hours with standard voltage after insertion and separation of the connector repeatedly 10 times by hands. Then pick specimen out of the chamber and leave it at room temperature for 2 hours or more. After that, the specimen must meet the requirements of the applicable evaluation tests.														
	Voltage Drop	Max $50\text{m}\Omega$															
	Insulation Resistance	Min $10\text{ k}\Omega$															
	High voltage	There shall be no insulation break															
Temperature and humidity cycle test	Appearance	No crack, damage, distortion are permitted	Engage and disengage connector 10 times by hands, and perform 10 cycles. Then pick specimen out of chamber and leave it at room temperature for 2 hours or more.														
	Voltage Drop	Max $50\text{m}\Omega$															
	Insulation Resistance	Min $10\text{ k}\Omega$															
<p>[Figure 11. Temperature and humidity cycle test condition]</p>																	
Dust Test	Voltage Drop	Max $50\text{m}\Omega$	Engage and disengage connector with terminal assembled 10 times with hands, and diffuse 1.5kg Portland cement (JIS R5210) with fan (or others) for 10 seconds per 15 minutes while maintaining 150mm distance from wall in the closed container of 900~1200mm length, width and height, with connector combined. After 1 hour, measure it.														
Sulfur test	Appearance	No crack, damage, distortion are permitted	Engage and disengage connector 10 times with hands, and expose it state of $\text{SO}_2$ , 10ppm density, $40\pm 3^{\circ}\text{C}$ temperature and 90~95% humidity for 24 hours. Then pick specimen out of chamber and leave it at room temperature for 2 hours or more.														
	Voltage Drop	Max $50\text{m}\Omega$															
Shock test	Appearance	No crack, damage, distortion are permitted	Connector shall be mounted in PCB board. After testing connector with half sine wave and following conditions, connector must meet the requirements of appearance, voltage drop and instantaneous short.														
	Voltage Drop	Max $50\text{m}\Omega$															
	Instant short circuit	Max $10\ \mu\text{s}$															
Complex environment endurance test	Appearance	No crack, damage, distortion are permitted	Engage and disengage connector 10 times by hand, and then perform the test with the conditions of complex environment endurance test in combined with vibration tester as following below figure. Then measure instant short circuit.														
	Voltage Drop	Max $50\text{m}\Omega$															
	Temperature Rise	Max $40^{\circ}\text{C}$															
	Instant short circuit	Max $10\ \mu\text{s}$															
<table border="1"> <thead> <tr> <th>Division</th> <th>Conditions</th> </tr> </thead> <tbody> <tr> <td>Ambient temperature/humidity</td> <td><math>80^{\circ}\text{C}</math>, 90~95%</td> </tr> <tr> <td>Applied current</td> <td>Basic current(Connect electrodes in series.)</td> </tr> <tr> <td>Current application cycle</td> <td>120 CYCLE(45minutes-ON, 15minutes-OFF)</td> </tr> <tr> <td>Vibration acceleration</td> <td>4.4 g</td> </tr> <tr> <td>Frequency</td> <td>20 Hz ~ 200 Hz (Sweep Time max3 minutes)</td> </tr> <tr> <td>Vibration time</td> <td>40 hours for , Y, each</td> </tr> </tbody> </table> 				Division	Conditions	Ambient temperature/humidity	$80^{\circ}\text{C}$ , 90~95%	Applied current	Basic current(Connect electrodes in series.)	Current application cycle	120 CYCLE(45minutes-ON, 15minutes-OFF)	Vibration acceleration	4.4 g	Frequency	20 Hz ~ 200 Hz (Sweep Time max3 minutes)	Vibration time	40 hours for , Y, each
Division	Conditions																
Ambient temperature/humidity	$80^{\circ}\text{C}$ , 90~95%																
Applied current	Basic current(Connect electrodes in series.)																
Current application cycle	120 CYCLE(45minutes-ON, 15minutes-OFF)																
Vibration acceleration	4.4 g																
Frequency	20 Hz ~ 200 Hz (Sweep Time max3 minutes)																
Vibration time	40 hours for , Y, each																

## 3.4 Applied Part No List

<b>TE Part no</b>	<b>Description</b>
1743282-1 1-1743282-2	MQS 8P PLUG HSG
1743283-1	MQS 8P PLUG DBL HSG
1743284-1 1-1743284-2 2-1743284-2 9-1743284-1	MQS 8P HEADER ASSEMBLY (H-TYPE)
1743386-1 1-1743386-2 1-1743386-6	MQS 8P HEADER ASSEMBLY (V-TYPE)
936289-2/3/5 3-936289-4	MQS 6P PLUG HSG
936640-2/3	MQS 6P HEADER ASSEMBLY (V-TYPE)
1-936119-1/2/3	MQS 4P PLUG ASSY
1743218-5	MQS 4P HEADER ASSEMBLY
1743164-1/2	MQS 3P PLUG HSG