

REVISIONS

P	LTR	DESCRIPTION	DATE	DWN	APVD
	A	INITIAL	14APR2015	DW	CW
	B	ECR-15-018270	09DEC2015	DW	CW
	B1	ECR-16-006849	13MAY2016	RL	CW
	C	ECR-21-111798	28SEP2021	WQR	CW

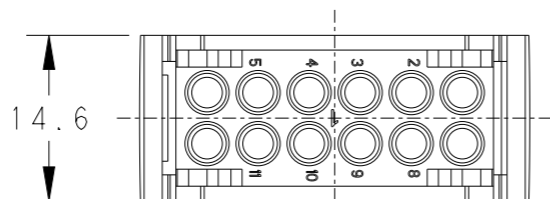
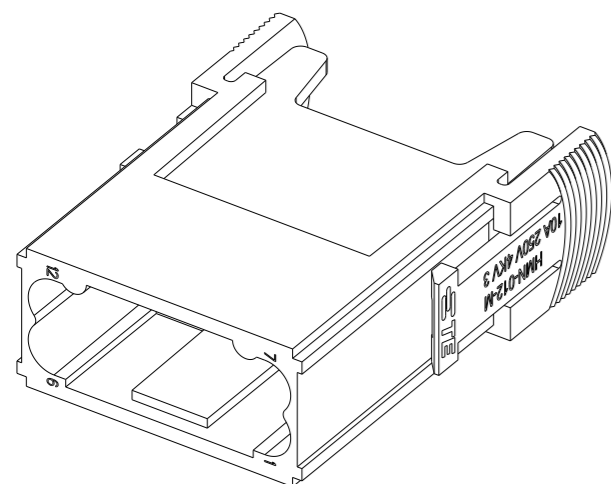

勝特力電材超市-龍山店 886-3-5773766
 勝特力電材超市-光復店 886-3-5729570
 勝特力电子(上海) 86-21-34970699
 勝特力电子(深圳) 86-755-83298787
<http://www.100y.com.tw>

NOTES:

- TECHNICAL CHARACTERISTICS:
 INSULATION MATERIAL: PC
 RATED VOLTAGE: 250V
 RATED CURRENT: 10A
 INSULATION RESISTANCE: $\geq 400M\Omega$
 RATED IMPULSE VOLTAGE: 4KV
 POLLUTION DEGREE: 3
 FLAMMABILITY: UL94V-0
 MATING CYCLES: 500 CYCLES
 OPERATION TEMPERATURE: $-40\sim+125^{\circ}C$
 WIRE RANGE: $0.14\sim 2.5\text{ mm}^2$ (26~14 AWG)
 CONTACT TYPE: CRIMP CONTACT
- CONTACT NEED TO BE ORDERED SEPARATELY.
 (ORDER No. REFER TO DRAWING: T20200X10XX000)

注释:

- 技术参数:
 绝缘材料: PC
 额定电压: 250V
 额定电流: 10A
 绝缘电阻: $\geq 400M\Omega$
 额定脉冲电压: 4KV
 污染等级: 3
 阻燃等级: UL94V-0
 插拔次数: 500次
 工作温度: $-40\sim+125^{\circ}C$
 接线范围: $0.14\sim 2.5\text{ mm}^2$ (26~14 AWG)
 接线类型: 冷压接
- 端子需要单独订购.
 (订货号参考图面: T20200X10XX000)

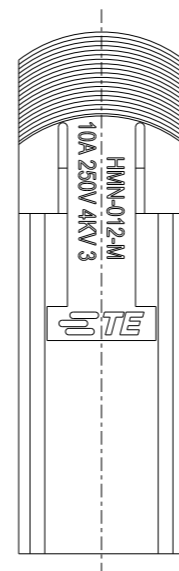
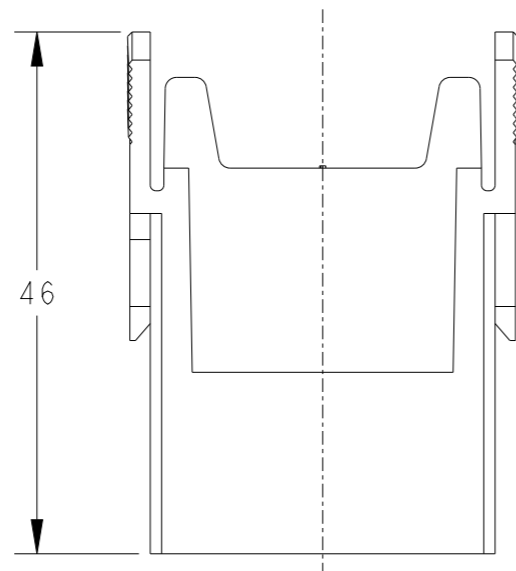
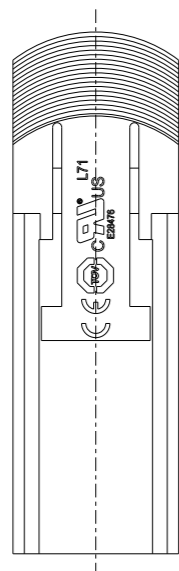

T2111122101-000 SHOWN,
带 LOGO, 产品型号, 认证标示

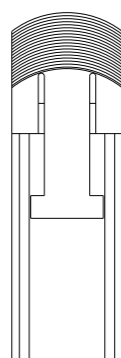
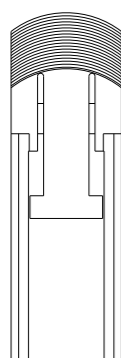
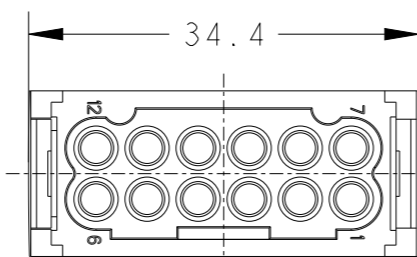

T2111122101-001 SHOWN, ALL DIMENSIONS ARE SAME AS T2111122101-000, EXCEPT WITHOUT LOGO, TYPE DESCRIPTION, TUV AND CUL MARK
不带 LOGO, 产品型号和认证标示

T2111122101-001	HMN-012-M WITHOUT LOGO HMN-012模块公插 不带LOGO, 产品型号和认证标示
T2111122101-000	HMN-012-M WITH LOGO HMN-012模块公插
PART NUMBER 料号	PART DESCRIPTION 描述

THIS DRAWING IS A CONTROLLED DOCUMENT.		DWN	14APR2015	 TE Connectivity	
DIMENSIONS: mm		CHK	14APR2015		
TOLERANCES UNLESS OTHERWISE SPECIFIED:		APVD	14APR2015		
0 PLC ±- 1 PLC ±- 2 PLC ±- 3 PLC ±- 4 PLC ±- ANGLES ±-		NAME	HMN-012-M		
MATERIAL		PRODUCT SPEC	108-137121	SIZE	A3
		FINISH	-	CAGE CODE	00779
				DRAWING NO	T2111122101000
				RESTRICTED TO	-
				WEIGHT	-
				Customer Drawing	
				SCALE	1:1
				SHEET	1 OF 1
				REV	C



HMN-012 Insert Series

Table of contents

1. SCOPE	2
1.1. Content	2
1.2. Qualification	2
2. APPLICABLE DOCUMENTS	2
2.1. TE Connectivity Documents.....	2
2.2. Other Documents.....	2
3. REQUIREMENTS	3
3.1. Design and Construction.....	3
3.2. Materials	3
3.3. Rated	3
3.4. Performance and Test Description	3
3.5. Test Requirements and Procedures Summary.....	3
3.6. Test Sequences	8
4. QUALITY ASSURANCE PROVISIONS	9
4.1. Qualification Testing.....	9
4.2. Requalification Testing.....	9
4.3. Acceptance	9
4.4. Quality Conformance Inspection.....	9

1. SCOPE

1.1. Content

This specification covers the performance, tests and quality standards for the contact inserts of heavy duty connector series **HMN-012-M/F**. The contact inserts are available for positions number 12. The termination conductor-contact insert is affected via a crimp contact which is fitted into the contact insert.

The contact insert is designed for conductors of 0.14 mm² up to 2.5 mm².

1.2. Qualification

When tests are performed, the following specified specifications and standards shall be used. All inspections shall be performed using the applicable inspection plan and product drawing.

2. APPLICABLE DOCUMENTS

The following documents form part of this specification to the extent specified herein. In the case of a conflict between the requirements of this specification and the product drawing or of conflicts between the requirements of this specification and the referenced documents, this specification shall take precedence.

2.1. TE Connectivity Documents

A. Customer drawing and name
HMN-012 insert series

2.2. Other Documents

- EN 61984: Connectors - Safety requirements and tests
- EN 50467: Electrical connectors - requirements and test - Railway applications
- IEC 60068: Environmental testing
- IEC 60512: Connectors for electronic equipment -Test and measurements
- IEC 60529: Degrees of Protection Provided by Enclosures (IP Code)
- IEC 60664-1: Insulation coordination for equipment within low-voltage systems (Part 1)
- EN 61373: Railway application - Rolling stock equipment - Shock and vibration test
- ISO 6988: Metallic and other non-organic coatings - Sulfur dioxide test with general condensation of moisture



3. REQUIREMENTS

3.1. Design and Construction

Product shall be of the design, construction and physical dimensions specified on the applicable product drawing.

3.2. Materials

Materials used in the construction of this product shall be as specified on the applicable product drawing.

3.3. Rated

- Rated Current / Voltage / Impulse Voltage / Pollution Degree
10A 250V 4KV 3
- Operation Temperature -40°C ~+125°C
- Degree of Protection IP20
- Protection Class II
- Overvoltage Category III

3.4. Performance and Test Description

Product shall be designed to meet the electrical, mechanical and environmental performance requirements specified in Paragraph 3.5. Unless otherwise specified, all tests shall be performed at ambient environmental conditions per IEC 60512 / EN 61984.

3.5. Test Requirements and Procedures Summary

General			
No.	Test Items	Requirements	Condition according to
3.5.1	Visual and dimensional examination	Meets requirements of product drawing	Visual and dimensional examination IEC 60512-1-1/-2, Test 1a and 1b 6.2 of EN 61984

Mechanical			
3.5.2	Durability of marking	Marking shall be still readable according to 6.2 of EN61984 (If marking made by impression, molding, pressing or engraving or the like are not subjected to this test)	Test piston: No. 1 Wet test with liquid: water Duration: 10 cycles Force:5N IEC 60068-2-70 Test Xb 7.3.2 of EN61984
3.5.3	Polarisation and coding	For multi-pole connector, require provision against incorrect mating according to 6.3 & 6.9.1 of EN 61984 No damage likely to impair function	For unenclosed connector (internal connections) 20N For enclosed connector (external connections) 1.5 x Mating force, but not higher than 80N Test 13e of IEC 60512-13-5

	Pull out force of terminations	See 6.6 of EN 61984	See 6.6 of EN 61984
3.5.4	for Crimped connections	Crimped termination 0.05 to 10mm ² not insulated, the conductor shall not slip out of crimp barrel and pull out force as specified in Table 1 of EN 60352-2	Visual tests on the crimp barrel and tensile strength test of the crimp connection as specified in IEC 60352-2.
		Crimped termination >10mm ² not insulated, the conductor shall not slip out of crimp barrel and pull out force as specified in Table 8 of NF F 00-363	Visual tests on the crimp barrel and tensile strength test of the crimp connection as specified in NF F 00-363
3.5.5	Contact retention force in insert	No axial displacement likely to impair normal operation, min 50N force for each pin or socket 6.18.2 of EN 61984	Test load applied in axial direction, test speed:20mm/min, permissible shift contacts of 1.0mm, Test 15a of IEC 60512-15-1
3.5.6	Mechanical strength impact	Connector and internal insulation shall no damage to impair normal use. A reduction of clearance and creepage distance is not allowed. 6.18.1 & 6.18.3 of EN 61984	Dropping height: - 750mm for specimens of mass ≤ 250g - 500mm for specimens of mass >250g Dropping cycles:8 positions in 45° step, one cycles per position IEC 60512-7-2 Test 7b
3.5.7	Mechanical Operation (Durability)	500 operation cycles without load No damage likely to impair normal use 6.14.1 of EN 61984	Shall be engaged and disengaged by means of A) a device simulating normal operating conditions at the speed of approximately 50mm/min B) manual mating/un-mating 300 Max. cycle per hour IEC 60512-9-1 Test 9a 7.3.9 of EN 61984
3.5.8	Vibration, Simulated long life random at increased levels	No damage likely to impair function No discontinuities greater than $t > 1\mu s$	Frequency:5~150Hz Per EN 61373, Category 1, Class B (IEC60068-2-6 Test Fc)
3.5.9	Vibration, Random	No damage likely to impair function No discontinuities greater than $t > 1\mu s$	Frequency:5~150Hz Per EN 61373, Category 1, Class B, (IEC60068-2-6 Test Fc)
3.5.10 ^a	^a Vibration, Simulated long life random at increased levels	No damage likely to impair function No discontinuities greater than $t > 1\mu s$	Frequency:5~150Hz Per EN 61373, Category 2, (IEC60068-2-6 Test Fc)
3.5.11 ^a	^a Vibration, Random	No damage likely to impair function No discontinuities greater than $t > 1\mu s$	Frequency:5~150Hz Per EN 61373, Category 2, (IEC60068-2-6 Test Fc)
3.5.12	Shock	No damage likely to impair function No discontinuities greater than $t > 1\mu s$	Acceleration:50m/s ² Duration:30ms Total 18 shocks(three positive and three negative in each of the three orthogonal axes) Per EN 61373

Electrical				
3.5.13	Contact Resistance	Initial	Max.5mΩ	Test current: 1A Measure points ^b at the end of the termination Max three contacts per specimen plus protective earthing, if any IEC 60512-2-2 Test 2b
		Final	The change of contact resistance shall be no more than 50 % of the reference value or ≤5 mΩ. The higher value is permissible	
3.5.14	Contact Resistance (Crimped termination 0.05 to 10mm ² not insulate)	Contact resistance at crimping has to be lower than the one specified in EN60352-2, Figure 6		IEC 60512-2-2, Test 2b (Method of specified current): testing current = 1A / mm ² of cable cross section EN 60352-2, 5.2.3.1 + Figure 5 for measuring points
3.5.15	Temperature Rise Test	The sum of the ambient temperature and the temperature rise (ΔT) of a connector shall not exceed the upper limiting temperature 6.16 of EN 61984		Length of test cable see table 7 of 7.3.8 of EN 61984 Carry its rated current Upper limiting temperature:125°C (Table 5b) IEC 60512-5-1 Test 5a
3.5.16	Dielectric Voltage Withstand Test	No flashover or breakdown of voltage 6.13 of EN 61984		Impulse test voltage according to Table 8, applied three impulses of each polarity and interval of at least 1s between impulses. 7.3.12 of EN 61984
3.5.17	Insulation Resistance	Not less than 400MΩ		Test voltage 1000V DC Time:60s IEC 60512-3-1 Test 3a Method B
3.5.18	Provision for earthing-Grounding contact resistance (if applicable)	Resistance is less than or equal to 0.1 Ω 6.5.3 of EN 61984		Resistance between accessible metal parts and the earthing contact 7.3.13 of EN 61984

Environmental			
3.5.19	Cold	No damage likely to impair function	Subject mated specimen to -40°C Duration time:16h, Test Ab Per IEC 60512-11-10 Test 11j (IEC 60068-2-1)
3.5.20	Dry Heat	No damage likely to impair function	Subject mated specimen to +125°C Duration time:168h Test Bb Per IEC 60512-11-9 Test 11i (IEC 60068-2-2)
3.5.21	Damp Heat, cyclic	No damage likely to impair function	Subject mated specimen to Min ambient temperature: 25±2°C Max ambient temperature: 40±2°C Number of cycles:21 Duration time:12h+12h Variant 1 IEC 60512-11-12 Test 11m
3.5.22	Rapid Change of temperature (Temperature Cycle)	No damage likely to impair function	Subject mated specimen to Ta=-40±2°C to Tb=+125±2°C, duration t1: 1h each extreme, 100 cycles IEC 60512-11-4 Test 11d (IEC 60068-2-14 Test Na)
3.5.23	Corrosion (Alternative)	No damage likely to impair function Per 6.21 of EN 61984	Test 1: Flowing mixed gas corrosion according to test 11g, method 1 or method 4 (Table 1) Duration time: 4day (96h) IEC 60512-11-7 Test 11g 7.3.14 of EN 61984
			Test 2: Sulphur dioxide test with general condensation of moisture according to EN ISO 6988 Duration time:24h (1 test cycle) 7.3.14 of EN 61984
3.5.24	Protection against electric shock	no live parts shall be accessible by test finger, 6.4.2.2 or 6.4.2.3 of EN 61984	Unenclosed connector. Test finger or 50mm sphere pressed with 20N against the surface as specified by the manufacture Mated specimen and socket connector (if application) 7.3.6.1 of EN 61984
<p>^a test items are for the special application, for example: Rail application etc. ^b measuring point: at the conductors as close as possible to the termination, if this is not possible, the conductor resistance shall be recalculated.</p>			



Number of Specimen as below table 1:

Table 1 - Number of Specimen		
Test	Description	Numbers & consist of
Group A	Mechanical Test	3 pairs connectors
Group B	Service life Test	3 pairs connectors
Group C	Temperature rise Test, Mated	3 pairs connectors
Group D	Climatic Test, Mated	3 pairs connectors
Group E	Degree of protection Test	3 pairs connectors
Group F	Temperature Cycle Test	3 pairs connectors
Group G	Vibration and Shock Test	3 pairs connectors (assemble with Hood & Housing)
Group H	Crimp Test	3 pairs pin and socket contact with 0.14mm ² wire & 3 pairs pin and socket contact with 2.5mm ² wire

Note: For connector family of the same design and comparable size, test may be made only on that member of the family which represents the worse case for that test.

3.6. Test Sequences

Test or Examination	Test Group							
	A	B	C	D	E	F	G	H
	Test Sequence ¹⁾							
Visual and dimensional examination	1,6	1,5	1,3	1,11	1,5	1,8	1,9	1,4
Durability of marking	2							
Polarisation and coding (If application)	3							
Pull out force of terminations for Crimped connections								3
Contact retention force in insert	4							
Mechanical strength impact	5							
Mechanical Operation (Durability)		3						
Vibration, Simulated long life random Category 1, Class B							3	
Vibration, Random, Category 1, Class B							4	
^a Vibration, Simulated long life random Category 2							5 ^a	
^a Vibration, Random, Category 2							6 ^a	
Shock							7	
Contact Resistance		2,4		2,8		2,5	2,8	
Contact Resistance (Crimped termination 0.05 to 10mm ² not insulate)								2
Temperature Rise Test			2					
Dielectric Voltage Withstand Test				3,9	4	6		
Insulation Resistance				4,10		7		
Provision for earthing-Grounding contact resistance (if applicable)					3			
Cold				5				
Dry Heat				6				
Damp Heat, cyclic						4		
Rapid Change of temperature (Temperature Cycle)						3		
Corrosion				7				
Protection against electric shock					2			

Notes:

- 1) Numbers indicate the sequence in which the tests are performed.
- 2) ^a test items are for the special application, for example: Rail application etc.

4. QUALITY ASSURANCE PROVISIONS

4.1. Qualification Testing

A. Specimen Selection

Specimens shall be prepared in accordance with applicable Instruction Sheets and shall be selected at random from current production.

B. Test Sequence

Specimens shall be tested in accordance with the paragraph 3.6 test sequence.

4.2. Requalification Testing

If changes significantly affecting form, fit or functions are made to the product or manufacturing process, product assurance shall coordinate requalification testing, consisting of all or part of the original testing sequence as determined by development/product, quality and reliability engineering.

4.3. Acceptance

Acceptance is based on verification that the product meets the requirements of paragraph 3.5. Failures attributed to equipment, test setup or operator deficiencies shall not disqualify the product. If product failure occurs, corrective action shall be taken and specimens resubmitted for qualification. Testing to confirm corrective action is required before re-submittal.

4.4. Quality Conformance Inspection

The applicable quality inspection plan shall specify the sampling acceptable quality level to be used. Dimensional and functional requirements shall be in accordance with the applicable product drawing and this specification. Bulk wire resistance shall be subtracted from resistance readings.

勝特力電材超市-龍山店 886-3-5773766
勝特力電材超市-光復店 886-3-5729570
勝特力電子(上海) 86-21-34970699
勝特力電子(深圳) 86-755-83298787
<http://www.100y.com.tw>