

Data Sheet | Item Number: 734-148

THT male header; 1.0 x 1.0 mm solder pin; straight; 100% protected against mismatching; Pin spacing 3.5 mm; 18-pole; light gray

<https://www.wago.com/734-148>

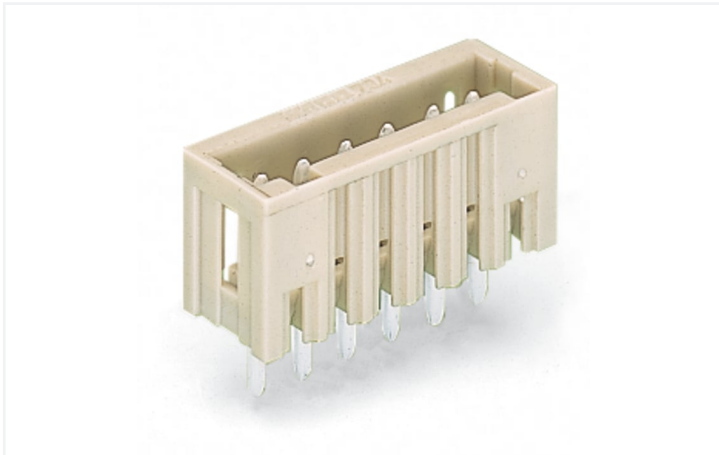

Color: ■ light gray

Similar to illustration

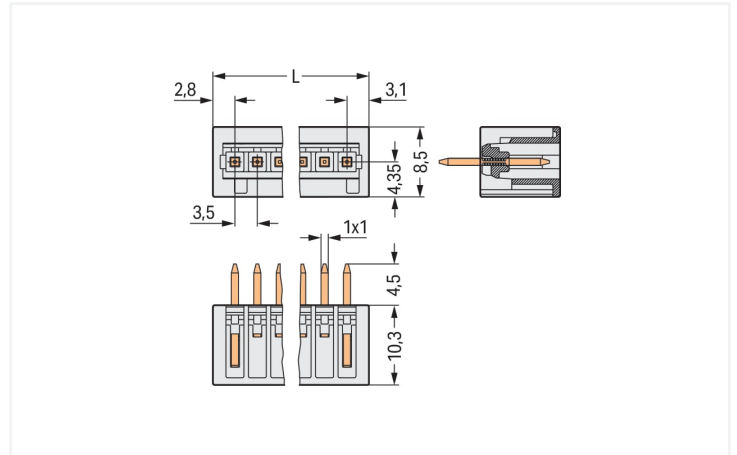

Dimensions in mm

L = (pole no. - 1) x pin spacing + 5.9 mm

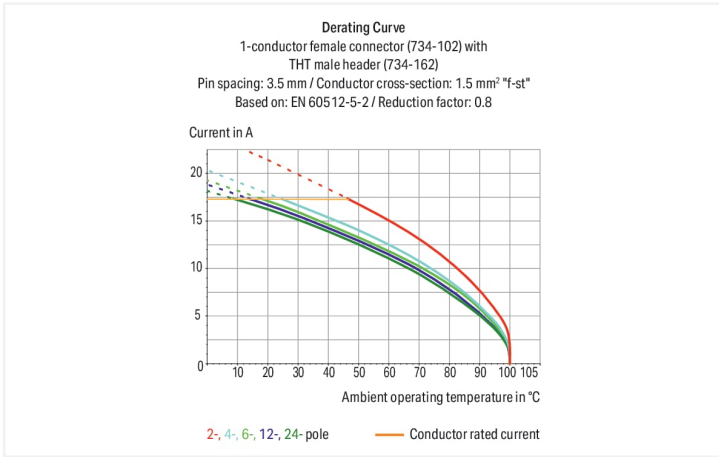

- Horizontal or vertical PCB mounting via straight or angled solder pins
- 100% protected against mismatching; only mating halves with the same number of poles can be connected together
- Coding option available

Notes

Safety Information

The MCS – MULTI CONNECTION SYSTEM includes connectors without breaking capacity in accordance with DIN EN 61984. When used as intended, these connectors must not be connected/disconnected when live or under load. When used as intended, these connectors must not be connected/disconnected when live or under load. The circuit design should ensure header pins, which can be touched, are not live when unmated.

Variants:

Other pole numbers
 3.8 mm pin projection for male headers with straight solder pins
 Gold-plated or partially gold-plated contact surfaces
 Other versions (or variants) can be requested from WAGO Sales or configured at <https://configurator.wago.com/>.

Electrical data

Rated current	IEC/EN 60664-1		
Overvoltage category	III	III	II
Pollution degree	3	2	2
Nominal voltage	160 V	160 V	320 V
Rated surge voltage	2.5 kV	2.5 kV	2.5 kV
Rated current	10 A	10 A	10 A

Rated current	UL 1059		
Use group	B	C	D
Rated voltage	300 V	-	300 V
Rated current	10 A	-	10 A

Approvals per	CSA		
	B	C	D
Use group	B	C	D
Rated voltage	300 V	-	300 V
Rated current	10 A	-	10 A

Connection data

Total number of potentials	18	Connection 1	
Number of connection types	1	Pole number	18
Number of levels	1		

Physical data

Pin spacing	3.5 mm / 0.138 inches
Width	65.4 mm / 2.575 inches
Height	14.8 mm / 0.583 inches
Height from the surface	10.3 mm / 0.406 inches
Depth	8.5 mm / 0.335 inches
Solder pin length	4.5 mm
Solder pin dimensions	1 x 1 mm
Drilled hole diameter with tolerance	1.4 ^(+0.1) mm

Mechanical data

Variable coding	Yes
Anti-rotation protection	Yes

Plug-in connection

Contact type (pluggable connector)	Male connector/plug
Connector (connection type)	for PCB
Mismating protection	Yes
Mating direction to the PCB	90 °

PCB contact

PCB contact	THT
Solder pin arrangement	over the entire male connector (in-line)
Number of solder pins per potential	1

Material data

Note (material data)	Information on material specifications can be found here
Color	light gray
Material group	I
Insulation material (main housing)	Polyamide (PA66)
Flammability class per UL94	V0
Contact material	Electrolytic copper (E _{Cu})
Contact Plating	Tin
Fire load	0.067 MJ
Weight	4 g

Environmental requirements

Limit temperature range	-60 ... +100 °C
Processing temperature	-35 ... +60 °C

Environmental Testing (Environmental Conditions)

Test specification Railway applications – Rolling stock – Electronic equipment	DIN EN 50155 (VDE 0115-200):2022-06
Test procedure Railway applications – Rolling stock equipment – Shock and vibration tests	DIN EN 61373 (VDE 0115-0106):2011-04
Spectrum/Installation location	Service life test, Category 1, Class A/B
Function test with noise-like vibration	Test passed according to Section 8 of the standard
Frequency	$f_1 = 5 \text{ Hz}$ to $f_2 = 150 \text{ Hz}$ $f_1 = 5 \text{ Hz}$ to $f_2 = 150 \text{ Hz}$
Acceleration	0.101g (highest test level used for all axes) 0.572g (highest test level used for all axes) 5g (highest test level used for all axes)
Test duration per axis	10 min. 5 h
Test directions	X, Y and Z axes X, Y and Z axes X, Y and Z axes
Monitoring for contact faults/interruptions	Passed
Voltage drop measurement before and after each axis	Passed
Simulated service life test through increased levels of noise-like vibration	Test passed according to Section 9 of the standard
Extended test scope: Monitoring for contact faults/interruptions	Passed Passed
Extended test scope: Voltage drop measurement before and after each axis	Passed Passed
Shock test	Test passed according to Section 10 of the standard
Shock form	Half sine
Shock duration	30 ms
Number of shocks per axis	3 pos. und 3 neg.
Vibration and shock stress for rolling stock equipment	Passed

Commercial data

Product Group	3 (Multi Conn. System)
eCl@ss 10.0	27-44-04-02
eCl@ss 9.0	27-44-04-02
ETIM 9.0	EC002637
ETIM 8.0	EC002637
PU (SPU)	50 pcs
Packaging type	Box
Country of origin	PL
GTIN	4044918847773
Customs tariff number	85366930000

Environmental Product Compliance	
RoHS Compliance Status	Compliant, No Exemption

Approvals / Certificates

General approvals



Approval	Standard	Certificate Name
CCA DEKRA Certification B.V.	EN 61984	2169534.02
CCA DEKRA Certification B.V.	EN 61984	nl-54190
CSA DEKRA Certification B.V.	C22.2	1465035
UL Underwriters Laboratories Inc.	UL 1977	E 45171
UR Underwriters Laboratories Inc.	UL 1059	E45172

Declarations of conformity and manufacturer's declarations



Approval	Standard	Certificate Name
Railway WAGO GmbH & Co. KG	-	Railway Ready

Approvals for marine applications



Approval	Standard	Certificate Name
ABS American Bureau of Shipping	-	19-HG1869876-PDA
DNV DNV GL SE	-	TAE000016Z
LR Lloyds Register	IEC 61984	96/20035 (E5)

Downloads

Environmental Product Compliance

Compliance Search	
Environmental Product Compliance 734-148	↓

Documentation

Additional Information			
Technical Section	03.04.2019	pdf 2027.26 KB	↓

CAD/CAE-Data

CAD data

2D/3D Models 734-148 

CAE data

EPLAN Data Portal 734-148 

ZUKEN Portal 734-148 

PCB Design

Symbol and Footprint via SamacSys 734-148 

Symbol and Footprint via Ultra Librarian 734-148 

1 Compatible Products

1.1 System counterpart

1.1.1 Female connector/socket



Item No.: 734-118

1-conductor female connector; CAGE CLAMP®; 1.5 mm²; Pin spacing 3.5 mm; 18-pole; 100% protected against mismatching; 1,50 mm²; light gray



Item No.: 734-118/037-000

1-conductor female connector; CAGE CLAMP®; 1.5 mm²; Pin spacing 3.5 mm; 18-pole; 100% protected against mismatching; Lateral locking levers; 1,50 mm²; light gray



Item No.: 734-118/037-000/036-000

1-conductor female connector; CAGE CLAMP®; 1.5 mm²; Pin spacing 3.5 mm; 18-pole; 100% protected against mismatching; Lateral locking levers; Strain relief plate; 1,50 mm²; light gray



Item No.: 2734-118

1-conductor female connector; push-button; Push-in CAGE CLAMP®; 1.5 mm²; Pin spacing 3.5 mm; 18-pole; 100% protected against mismatching; 1,50 mm²; light gray



Item No.: 2734-118/027-000

1-conductor female connector; push-button; Push-in CAGE CLAMP®; 1.5 mm²; Pin spacing 3.5 mm; 18-pole; 100% protected against mismatching; clamping collar; 1,50 mm²; light gray



Item No.: 2734-118/037-000

1-conductor female connector; push-button; Push-in CAGE CLAMP®; 1.5 mm²; Pin spacing 3.5 mm; 18-pole; 100% protected against mismatching; Lateral locking levers; 1,50 mm²; light gray



Item No.: 734-548

THT female header; angled; Pin spacing 3.5 mm; 18-pole; 100% protected against mismatching; 0.9 x 0.9 mm solder pin; light gray



Item No.: 734-548/037-000

THT female header; angled; Pin spacing 3.5 mm; 18-pole; 100% protected against mismatching; Locking lever; 0.9 x 0.9 mm solder pin; light gray



Item No.: 734-478

THT female header; straight; Pin spacing 3.5 mm; 18-pole; 100% protected against mismatching; 0.9 x 0.9 mm solder pin; light gray



Item No.: 734-478/037-000

THT female header; straight; Pin spacing 3.5 mm; 18-pole; 100% protected against mismatching; Locking lever; 0.9 x 0.9 mm solder pin; light gray

1.2 Optional Accessories

1.2.1 Coding

1.2.1.1 Coding



Item No.: 734-159

Coding key; to be snapped above top level; black



Item No.: 734-130

Coding key; to be snapped above top level; white

Installation Notes

Coding

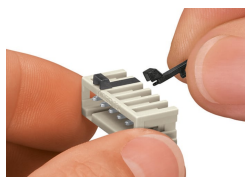

Coding a male header – fitting coding key (s).

勝特力電材超市-龍山店 886-3-5773766
勝特力電材超市-光復店 886-3-5729570
勝特力電子(上海) 86-21-34970699
勝特力電子(深圳) 86-755-83298787
<http://www.100y.com.tw>