

勝特力電材超市-龍山店 886-3-5773766  
 勝特力電材超市-光復店 886-3-5729570  
 勝特力電子(上海) 86-21-34970699  
 勝特力電子(深圳) 86-755-83298787  
<http://www.100y.com.tw>

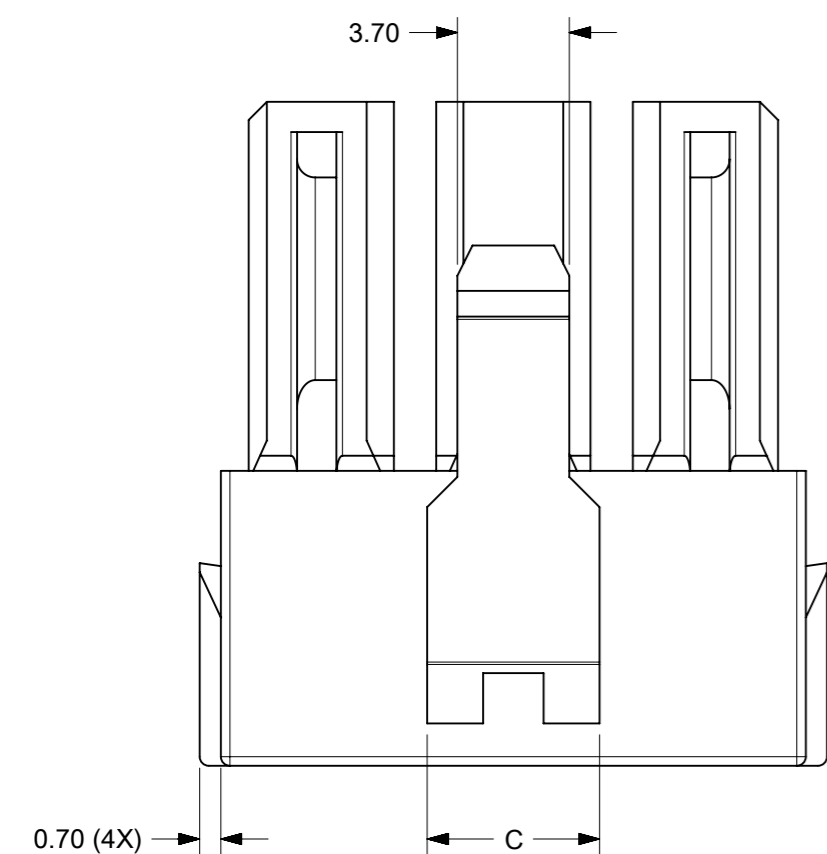
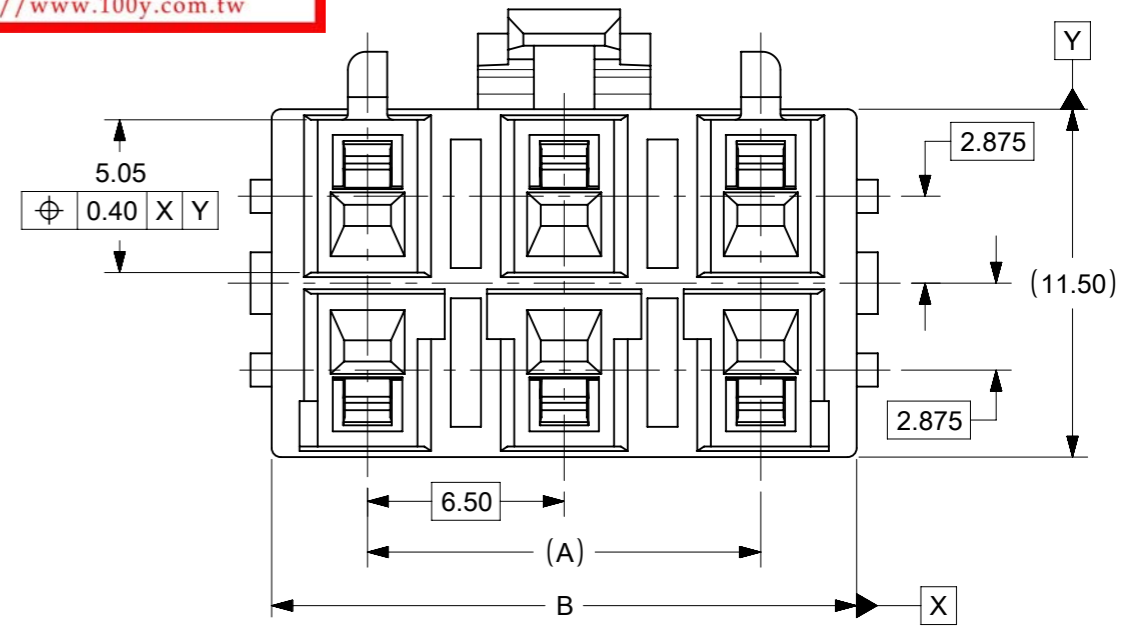
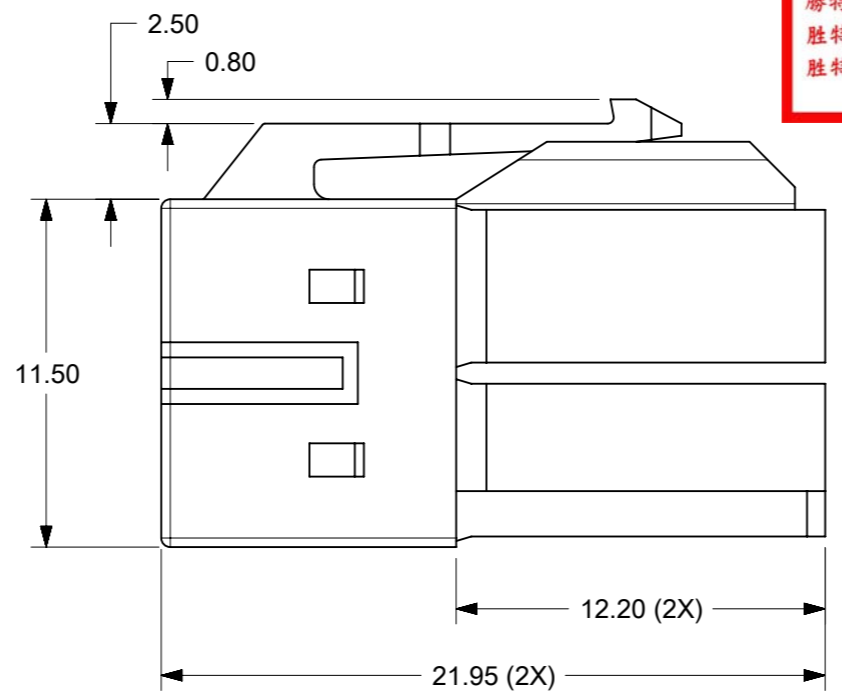
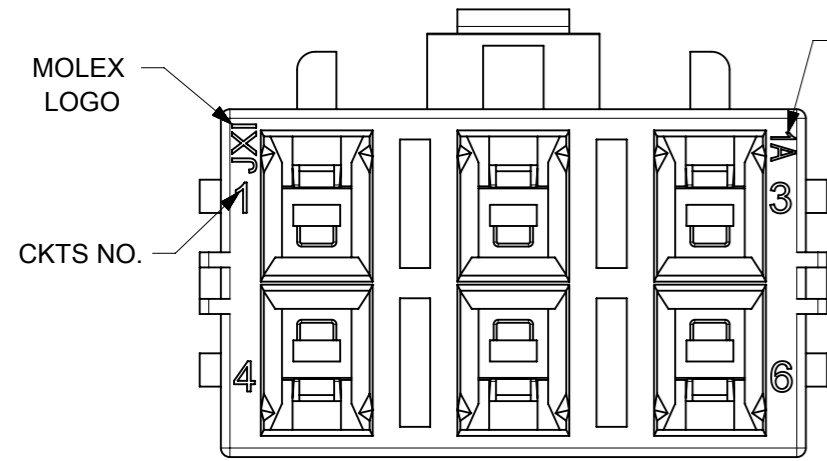

**PART NO. LEGEND**

151049 - \* \* \* \*

- COLOR
- CKT NO.
- OTHERS

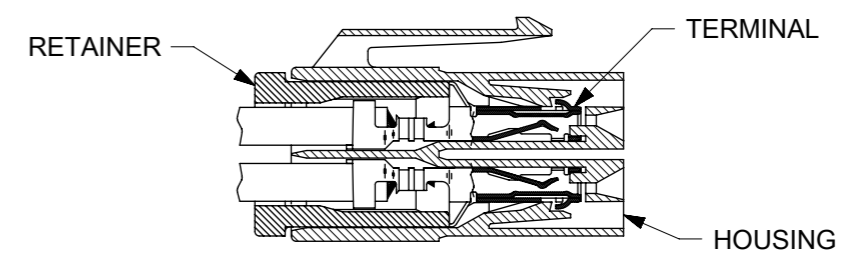

**TERMINAL AND RETAINER ASSEMBLY DRAWING**

- NOTES:**
- MATERIAL: HOUSING: PBTP, UL94V-0
  - APPLICATION TERMINAL :  
 50597 (FOR WIRE RANGE #16~#22)  
 50598 (FOR WIRE RANGE #20~#26)
  - APPLICATION RETAINER : 51143
  - REFER TO COSMETIC SPECIFICATION: PS-45499-002(CLASS B)
  - MATE WITH HEADER 151048 SERIES
  - PRODUCT SPECIFICATION: PS-151048-0001
  - PACKAGING SPECIFICATION: PK-151049-0001

6	13.00	19.34	5.70	REFER TO PG 4
4	6.50	12.84	3.70	REFER TO PG 3
2	-	6.34	5.70	REFER TO PG 2
<b>CKT. NO.</b>	<b>A</b>	<b>B</b>	<b>C</b>	<b>MATERIAL NO.</b>
<b>RELEASE STATUS</b>	P1	<b>RELEASE DATE</b>	18.07.2017	09:35:03

THIS DRAWING CONTAINS INFORMATION THAT IS PROPRIETARY TO MOLEX ELECTRONIC TECHNOLOGIES, LLC AND SHOULD NOT BE USED WITHOUT WRITTEN PERMISSION

MIGRATED TO NX EC NO: 119232 DRWN: GSHARMA CHK'D: BR02 APPR: KPRASAD	2017/06/07	2017/07/11	2017/07/18	GENERAL TOLERANCES (UNLESS SPECIFIED)	DIMENSION UNITS	SCALE			
	4 PLACES	±	MM		NTS				
	3 PLACES	±	DRWN BY		DATE	EANG		2014/03/13	
	2 PLACES	± 0.2	CHK'D BY		DATE	CGOH		2015/03/12	
	1 PLACE	±	APPR BY		DATE	KHLIM		2015/03/16	
0 PLACES	±	DRAFT WHERE APPLICABLE MUST REMAIN WITHIN DIMENSIONS		DRAWING SIZE	THIRD ANGLE PROJECTION	SALES DRAWING 6.5 RECEPTACLE HOUSING WIRE TO BOARD CONNECTOR			
<b>A</b>	REV			<b>A3</b>		PRODUCT CUSTOMER DRAWING			
						SERIES	MATERIAL NUMBER	CUSTOMER	
						151049	SEE TABLE	GENERAL MARKET	
						DOCUMENT NUMBER	DOC TYPE	DOC PART	SHEET NUMBER
						SD-151049-0001	PSD	001	1 OF 4

HOUSING WITH POLARIZATION FEATURES AND COLOR FOR 2CKTS

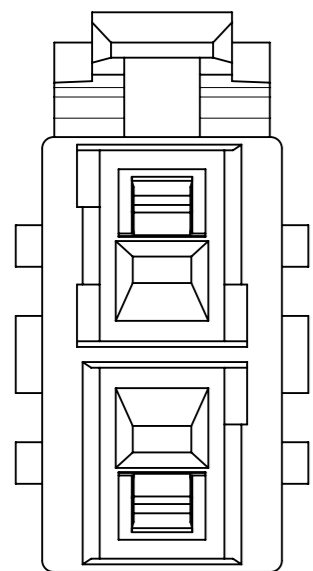

1 1510492200 ORANGE

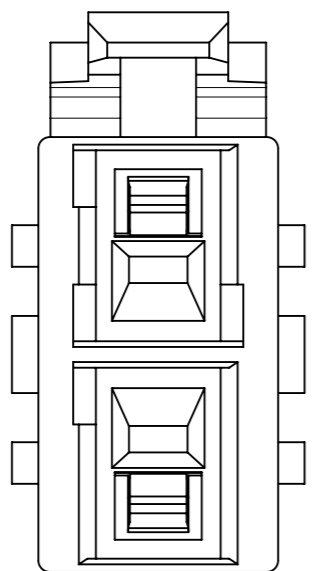

2 1510492201 BLUE

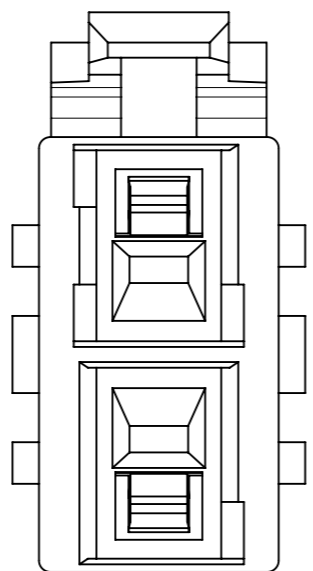

3 1510492202 GREY

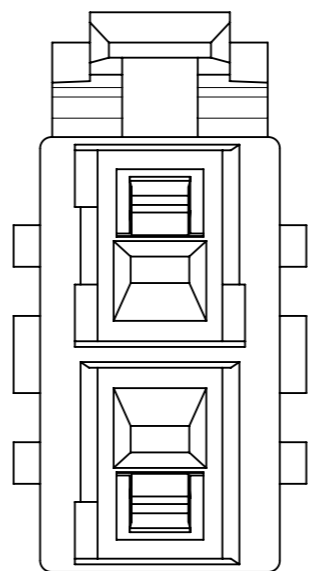

4 1510492203 YELLOW

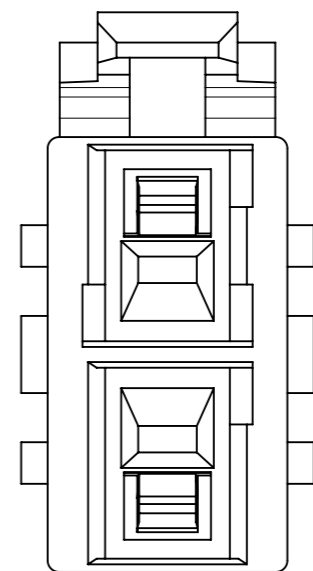

5 1510492204 PURPLE

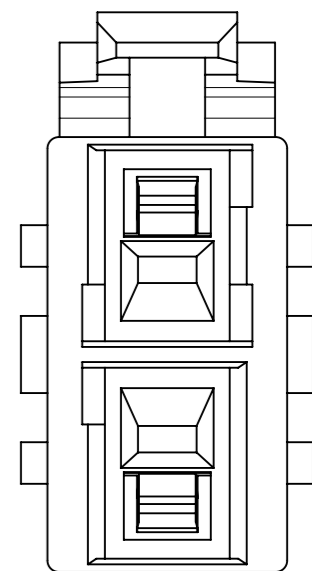

6 1510492205 PINK

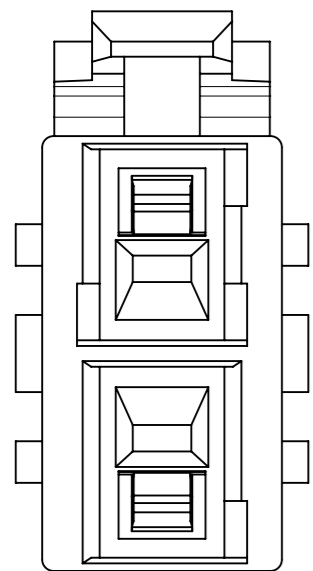

7 1510492206 BLACK

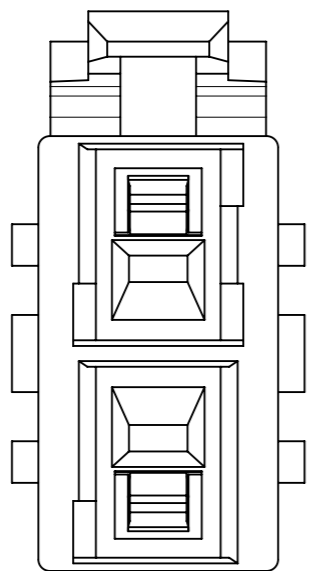

8 1510492207 GREEN

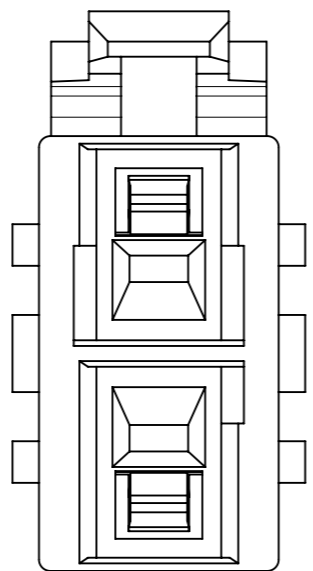

9 1510492208 BROWN

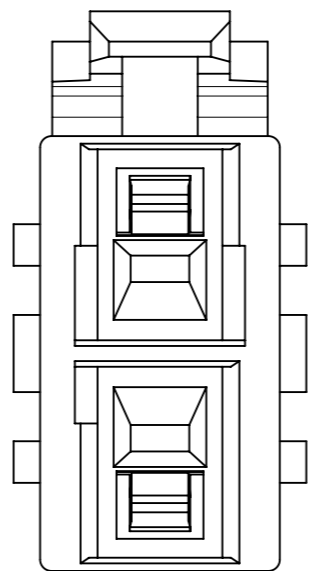

10 1510492209 RED

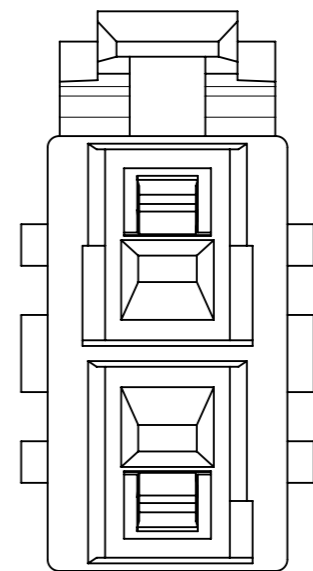

11 1510492210 MINT

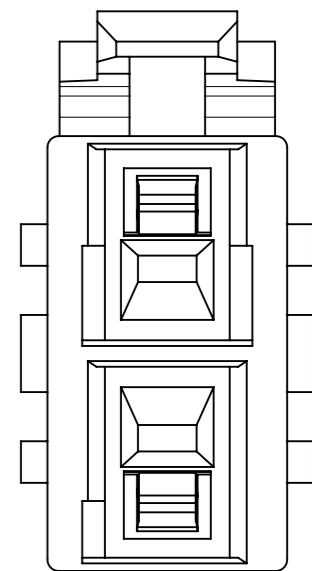

12 1510492211 NATURAL (WHITE)

1	1510492200	ORANGE	*	
2	1510492201	BLUE	*	
3	1510492202	GREY		*
4	1510492203	YELLOW	*	
5	1510492204	PURPLE		*
6	1510492205	PINK		*
7	1510492206	BLACK	*	
8	1510492207	GREEN		*
9	1510492208	BROWN		*
10	1510492209	RED	*	
11	1510492210	MINT		*
12	1510492211	NATURAL (WHITE)	*	
CONFIGURATION	ASSEMBLY	COLOR	STANDARD COLOR	CUSTOM COLOR

RELEASE STATUS P1 RELEASE DATE 18.07.2017 09:35:03

THIS DRAWING CONTAINS INFORMATION THAT IS PROPRIETARY TO MOLEX ELECTRONIC TECHNOLOGIES, LLC AND SHOULD NOT BE USED WITHOUT WRITTEN PERMISSION

EC NO: 119232 DRWN: GSHARMA CHK'D: BR02 APPR: KPRASAD	2017/06/07	GENERAL TOLERANCES (UNLESS SPECIFIED)		DIMENSION UNITS	SCALE		
	2017/07/11	ANGULAR TOL ± 3.0 °		MM	NTS		
	2017/07/18	4 PLACES ±	DRWN BY	EANG	DATE		2014/03/13
		3 PLACES ±	CHK'D BY	CGOH	DATE		2015/03/12
		2 PLACES ± 0.2	APPR BY	KHLIM	DATE		2015/03/16
	1 PLACE ±	DRAWING SIZE	THIRD ANGLE PROJECTION				
	0 PLACES ±	A3					
	DRAFT WHERE APPLICABLE MUST REMAIN WITHIN DIMENSIONS						
MIGRATED TO NX						SALES DRAWING 6.5 RECEPTACLE HOUSING WIRE TO BOARD CONNECTOR	
				PRODUCT CUSTOMER DRAWING			
		SERIES	MATERIAL NUMBER	CUSTOMER			
		151049	SEE TABLE	GENERAL MARKET			
		DOCUMENT NUMBER		DOC TYPE	DOC PART	SHEET NUMBER	
		SD-151049-0001		PSD	001	2 OF 4	

HOUSING WITH POLARIZATION FEATURES AND COLOR FOR 4CKTS

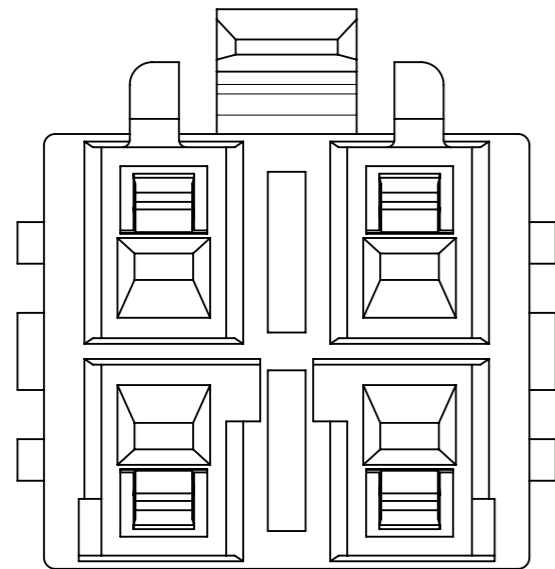

① 1510492401  
BLUE

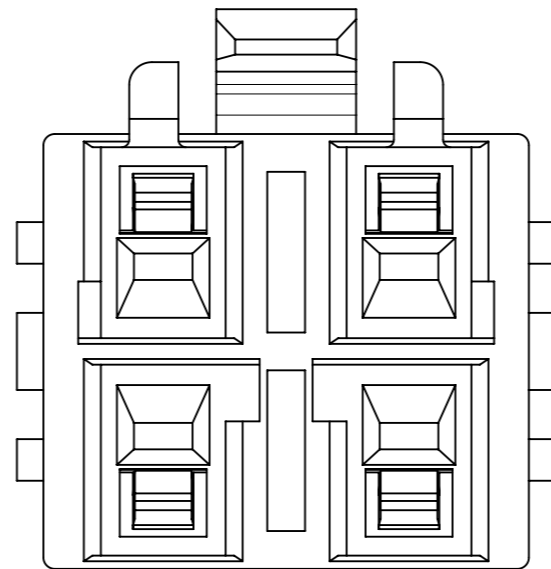

② 1510492406  
BLACK

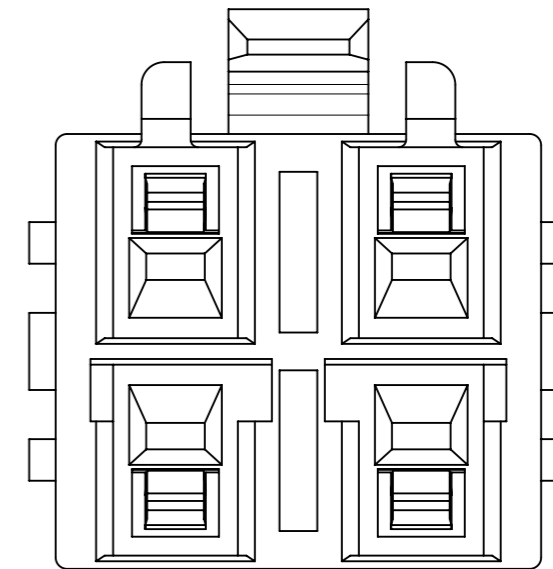

③ 1510492411  
NATURAL (WHITE)

1	1510492401	BLUE
2	1510492406	BLACK
3	1510492411	NATURAL (WHITE)
<b>CONFIGURATION</b>	<b>ASSEMBLY</b>	<b>COLOR</b>
RELEASE STATUS	P1	RELEASE DATE 18.07.2017 09:35:03

THIS DRAWING CONTAINS INFORMATION THAT IS PROPRIETARY TO MOLEX ELECTRONIC TECHNOLOGIES, LLC AND SHOULD NOT BE USED WITHOUT WRITTEN PERMISSION

MIGRATED TO NX EC NO: 119232 DRWN: GSHARMA CHK'D: BR02 REV APPR: KPRASAD	GENERAL TOLERANCES (UNLESS SPECIFIED)		DIMENSION UNITS	SCALE					
	ANGULAR TOL ± 3.0 °		MM	NTS					
	4 PLACES ±	EANG		DATE		SALES DRAWING 6.5 RECEPTACLE HOUSING WIRE TO BOARD CONNECTOR			
	3 PLACES ±	CGOH		DATE					
	2 PLACES ± 0.2	KHLIM		DATE		PRODUCT CUSTOMER DRAWING			
	1 PLACE ±	A3		THIRD ANGLE PROJECTION					
0 PLACES ±	DRAFT WHERE APPLICABLE MUST REMAIN WITHIN DIMENSIONS				SERIES	MATERIAL NUMBER	CUSTOMER		
				151049		SEE TABLE		GENERAL MARKET	
				DOCUMENT NUMBER		DOC TYPE	DOC PART	SHEET NUMBER	
				SD-151049-0001		PSD	001	3 OF 4	

HOUSING WITH POLARIZATION FEATURES AND COLOR FOR 6CKTS

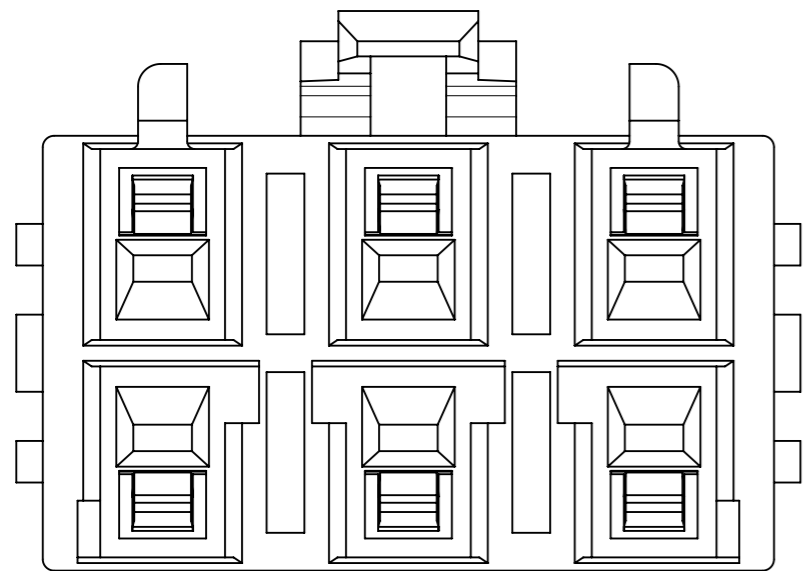

① 1510492601  
BLUE

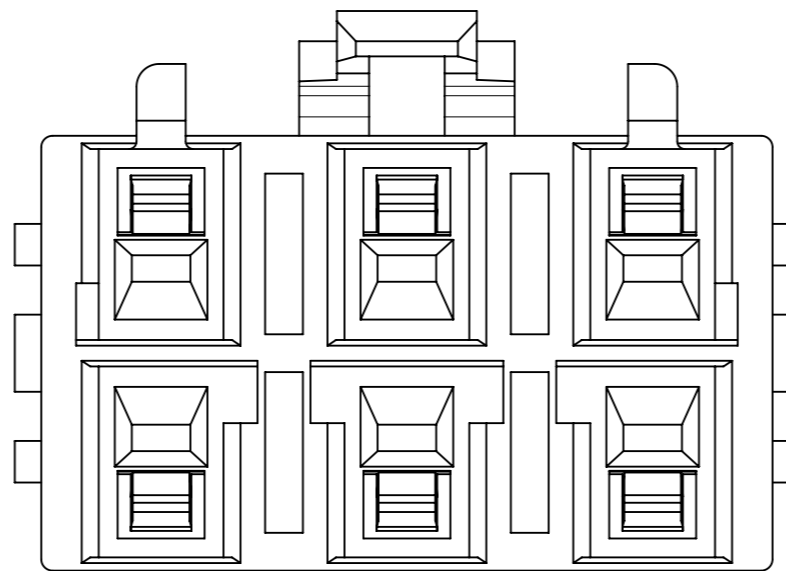

② 1510492606  
BLACK

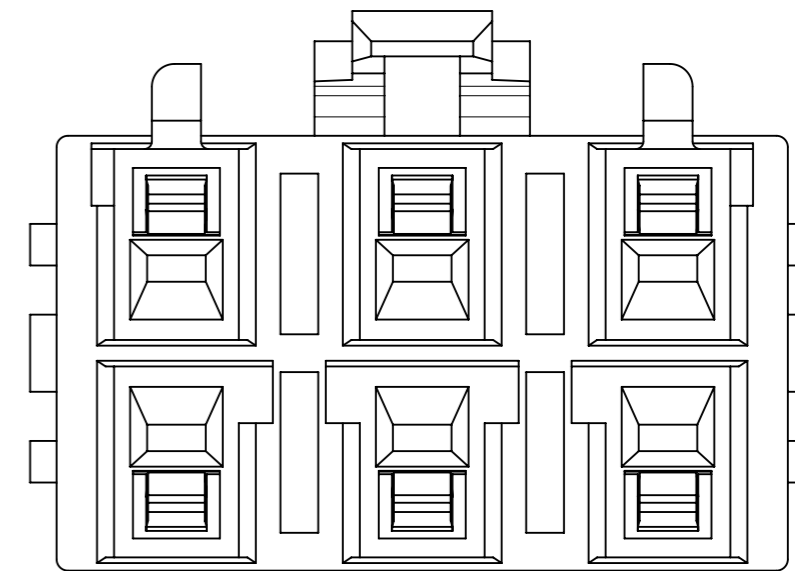

③ 1510492609  
RED

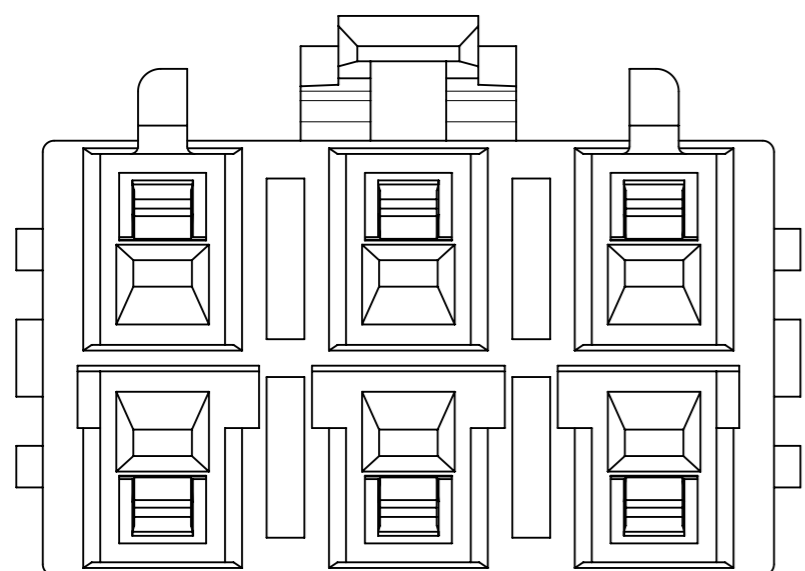

④ 1510492611  
NATURAL (WHITE)

1	1510492601	BLUE
2	1510492606	BLACK
3	1510492609	RED
4	1510492611	NATURAL (WHITE)
<b>CONFIGURATION</b>	<b>ASSEMBLY</b>	<b>COLOR</b>
RELEASE STATUS	P1	RELEASE DATE 18.07.2017 09:35:03

THIS DRAWING CONTAINS INFORMATION THAT IS PROPRIETARY TO MOLEX ELECTRONIC TECHNOLOGIES, LLC AND SHOULD NOT BE USED WITHOUT WRITTEN PERMISSION

EC NO: 119232 DRWN: GSHARMA CHK'D: BR02 APPR: KPRASAD 2017/06/07 2017/07/11 2017/07/18 MIGRATED TO NX	GENERAL TOLERANCES (UNLESS SPECIFIED)		DIMENSION UNITS	SCALE	<p>SALES DRAWING 6.5 RECEPTACLE HOUSING WIRE TO BOARD CONNECTOR</p> <p>PRODUCT CUSTOMER DRAWING</p> <p>SERIES: 151049 MATERIAL NUMBER: SEE TABLE CUSTOMER: GENERAL MARKET</p> <p>DOCUMENT NUMBER: SD-151049-0001 DOC TYPE: PSD DOC PART: 001 SHEET NUMBER: 4 OF 4</p>
	ANGULAR TOL ± 3.0 °		MM	NTS	
	4 PLACES ±	DRWN BY	DATE		
	3 PLACES ±	EANG	2014/03/13		
	2 PLACES ± 0.2	CHK'D BY	DATE		
1 PLACE ±	CGOH	2015/03/12			
0 PLACES ±	APPR BY	DATE			
DRAFT WHERE APPLICABLE MUST REMAIN WITHIN DIMENSIONS		KHLIM	2015/03/16		
		DRAWING SIZE	THIRD ANGLE PROJECTION		
		A3			



产品编号 : [1510492206](#)

Product Description : CP-6.5 Receptacle Housing, 6.50mm Pitch, Dual Row, Polarized, Positive Lock, 2 Circuits, Black

系列号 : 151049

状态 : Active

Product Category : Connector Housings



---

## 文件和资源

### 图纸

[图纸 1510492206\\_sd.pdf](#)

[包装设计图 PK-151049-0001-001.pdf](#)

### 3D 模型和设计文件

[3D模型 1510492206\\_stp.zip](#)

### 规格

[产品规格 PS-151048-0001-001.pdf](#)

[测试摘要 1510480001-TS-000.pdf](#)

---

## 产物环境合规

### 合规

GADSL/IMDS	Not Relevant
China RoHS	
EU ELV	Not Relevant
Low-Halogen Status	Not Low-Halogen per IEC 61249-2-21
REACH SVHC	Not Contained per D(2023)3788-DC (14 Jun 2023)
EU RoHS	Compliant per EU 2015/863

### 多部分产品合规性声明

- Eu RoHS
- REACH SVHC
- Low-Halogen

### 多部分行业合规性文件

- IPC 1752A Class C
- IPC 1752A Class D
- Molex Product Compliance Declaration
- IEC-62474
- chemSHERPA (xml)

欧盟 RoHS 合格证书

## 产品详情

### 常规

状态	活动
类别	Connector Housings
系列	151049
说明	CP-6.5 Receptacle Housing, 6.50mm Pitch, Dual Row, Polarized, Positive Lock, 2 Circuits, Black
应用	Power, Wire-to-Board
个评论	See Product Specification for maximum current rating by circuit size and wire AWG
产品系列	CP Wire-to-Board and Wire-to-Wire Connector Systems
产品名称	CP-6.5
UPC	889056065719

### 机构

CSA	LR19980
UL	E29179

### 物理

电路数（最多）	2
颜色-树脂	黑色
阻燃性	94V-0
性别	Receptacle
符合灼热丝规范	否
插接极性	是
锁定插接部位	是
材料 - 树脂	PBTP

净重	1.007/g
行数	2
包装形式	Bag
面板安装式	否
间距 - 插配接口	6.50mm
间距 - 终端界面	6.50mm
有极性的插配件	是
运行温度范围	-40° to +105° C

## 进程

无铅	不适用
----	-----

---

## 可配插/可连接使用的产品

### 可配插部件

描述	产品编号
CP-6.5 Header, 6.50mm Pitch, Dual Row, Vertical, Polarized, Positive Lock, Tray Packaging, Glow-Wire Capable, 2 Circuits, Black	<u>1510481206</u>
CP-6.5 Header, 6.50mm Pitch, Dual Row, Vertical, Polarized, Positive Lock, Tube Packaging, Glow-Wire Capable, 2 Circuits, Black	<u>1510482206</u>

### 可连接使用部件

描述	产品编号
CP-6.5 Wire-to-Board Crimp Terminal, Female, 16-22 AWG, Reel	<u><a href="/content/molex/molex-dot-com/cn/zh/products/product-page.html/505978000.html">/content/molex/molex-dot-com/cn/zh/products/product-page.html/505978000.html</a></u>
CP-6.5 Wire-to-Board Crimp Terminal, Female, 20-26 AWG, Reel	<u><a href="/content/molex/molex-dot-com/cn/zh/products/product-page.html/505988000.html">/content/molex/molex-dot-com/cn/zh/products/product-page.html/505988000.html</a></u>
CP-6.5 Terminal Position Assurance (TPA) Retainer, 1 Circuit	<u><a href="/content/molex/molex-dot-com/cn/zh/products/product-page.html/511430105.html">/content/molex/molex-dot-com/cn/zh/products/product-page.html/511430105.html</a></u>