



产品编号 : [16020082](#)

Product Description : SL Crimp Terminal, Series 70058, Female, 24-30 AWG, with 0.38µm Selective Gold (Au) Plated Contact, Reel

系列号 : 70058

状态 : Active

Product Category : Crimp Terminals

工程编号 : 70058-0006

Packaging Alternative : 0016020097 (Bag)



文件和资源

图纸

[图纸 016020082_sd.pdf](#)

规格

[产品规格 PS-70058-001.pdf](#)

[产品规格 PS-70400-001.pdf](#)

[测试摘要 TS-70058-001-001.pdf](#)

产物环境合规

合规

GADSL/IMDS	Compliant with Exemption 44; 34; 33
China RoHS	
EU ELV	Compliant per 2000/53/EC
Low-Halogen Status	Low-Halogen per IEC 61249-2-21
REACH SVHC	Not Contained per D(2023)3788-DC (14 Jun 2023)
EU RoHS	Compliant per EU 2015/863

多部分产品合规性声明

- Eu RoHS
- REACH SVHC
- Low-Halogen

多部分行业合规性文件

- IPC 1752A Class C
- IPC 1752A Class D
- Molex Product Compliance Declaration
- IEC-62474
- chemSHERPA (xml)

欧盟 RoHS 合格证书

产品详情

常规

状态	活动
类别	Crimp Terminals
系列	70058
说明	SL Crimp Terminal, Series 70058, Female, 24-30 AWG, with 0.38µm Selective Gold (Au) Plated Contact, Reel
应用	Signal, Wire-to-Board, Wire-to-Wire
产品系列	SL Modular Connectors
产品名称	CyClone, SL
UPC	800753595996

物理

性别	女
材料 - 金属	Phosphor Bronze
材料 - 接合部位电镀	金牌
材料 - 终端电镀	Tin
净重	114.800/mg
包装形式	Reel
最薄镀层 - 接合部位	0.380µm
最薄镀层 - 端接	2.000µm
终端界面类型	Crimp or Compression
导线绝缘直径	1.52mm max.
线径规格 (AWG)	24, 26, 28, 30
线缆尺寸mm ²	不适用

进程

无铅	不适用
----	-----

可连接使用部件

描述	产品编号
SL Single Row Crimp Housings and CPA Retainers	<u>70066</u>
SL Dual Row Crimp Housings	<u>70450</u>

施工工具

全局

描述	产品编号
Insertion Tool for 70021, 70028, 70110, 71851 Terminals / Extraction Tool for 91821 Terminals	<u>0011020022</u>
Extraction Tool for SL Terminals, 22-36 AWG	<u>0011030036</u>
Hand Crimp Tool for SL Crimp Terminals, 24-30 AWG	<u>2002187000</u>
FineAdjust Applicator for SL Female Crimp Terminal, Insulation OD 0.63-1.00mm, 24-30 AWG Wire	<u>0639001500</u>
FineAdjust Applicator for SL Female Crimp Terminal, Insulation OD 1.01-1.52mm, 24-30 AWG Wire	<u>0639003100</u>
T2 Terminator Tooling Die	<u>0639103100</u>

施工工具

日本

描述	产品编号
Applicator for M211A Bench Press, 22-30 AWG Wire	<u>0570143000</u>
Hand Insertion Tool	<u>0570336000</u>

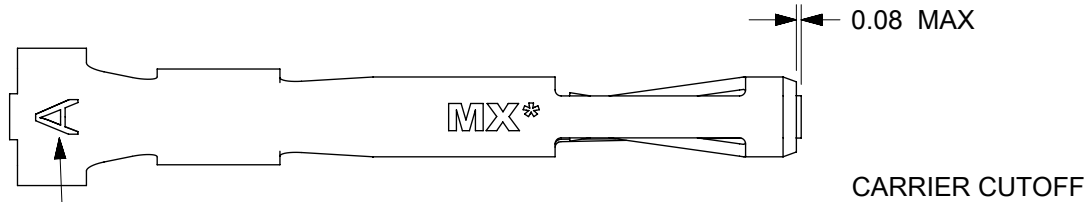
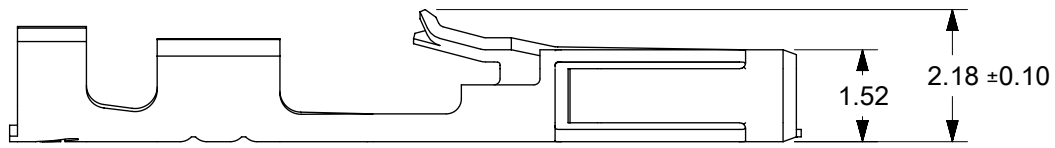
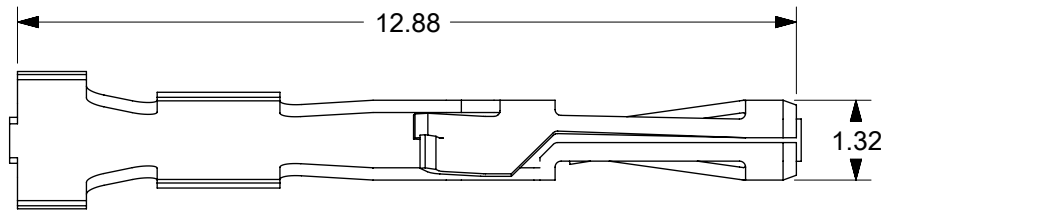

TERMINALS STAMPED WITH THE LETTER "A"
ACCEPT 24-30 AWG WIRE WITH A 1.52 MAX INSULATION DIA.

NOTES:

- MATERIAL: PHOSPHOR BRONZE
- PLATING:
 - 124 = SELECT BRIGHT TIN: 3.75 MICROMETERS MIN OVER NICKEL
 - P124 = PREPLATED BRIGHT TIN: 3.75 MICROMETERS MIN OVER MATTE NICKEL (BARE EDGES)
 - 207 = SELECT HARD GOLD: 0.38 MICROMETERS MIN.
SELECT TIN: 2.0 MICROMETERS MIN BOTH OVER NICKEL
 - 206 = SELECT HARD GOLD: 0.75 MICROMETERS MIN.
SELECT TIN: 2.0 MICROMETERS MIN BOTH OVER NICKEL
- PRODUCT SPECIFICATION: TERMINALS CONFORM TO PS-70058 AND PS-70400 WHEN CRIMPED WITH MOLEX CRIMP TOOLS.
- COSMETIC SPECIFICATION: PS-45499-002 CLASS B
- TERMINAL FOR USE WITH HOUSING SERIES 70066 AND 70450
- WIRE SPECIFICATION: TERMINALS STAMPED WITH THE LETTER:
A = ACCEPTS 24-30 AWG STRANDED WIRE WITH A 1.52 MAX INSULATION DIA
- SEE 700580000-SD FOR THIS PART WITH SINGLE NUMBER SYSTEM

TERMINALS ON THIS SHEET ARE FOR USE
WITH 24-30 AWG WIRE.
SEE SHEETS 2 AND 3 FOR OTHER WIRE SIZES

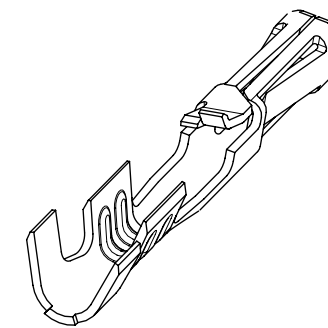

(24-30 AWG WIRE)

PART NUMBER / ENGINEERING NO	PACKAGING	PLATING SEE NOTE 2	WIRE SIZE	MAX INSULATION DIA
16-02-0069 70058-0004	REEL	124 SELECT TIN	24-30 AWG	1.52 DIA MAX
16-02-0096 70058-0204	LOOSE			
16-02-0082 70058-0006	REEL	207 0.38 GOLD		
16-02-0097 70058-0206	LOOSE			
16-02-0083 70058-0008	REEL	206 0.75 GOLD		
16-02-0098 70058-0208	LOOSE			

THIS DRAWING CONTAINS INFORMATION THAT IS PROPRIETARY TO MOLEX ELECTRONIC TECHNOLOGIES, LLC AND SHOULD NOT BE USED WITHOUT WRITTEN PERMISSION									
DIMENSION UNITS	SCALE	CURRENT REV DESC: OBSOLETE PART NUMBER AS PER PCN#508517							
mm	8:1								
GENERAL TOLERANCES (UNLESS SPECIFIED)		EC NO: 667105			SL CRIMP TERMINAL				
ANGULAR TOL ± °		DRWN: SUGEEB 2021/05/27							
4 PLACES ±		CHK'D: GGA 2021/06/29			PRODUCT CUSTOMER DRAWING				
3 PLACES ±		APPR: GGA 2021/06/29							
2 PLACES ± 0.15		INITIAL REVISION:			DOCUMENT NUMBER				
1 PLACE ± 0.25		DRWN: KSAMIEC 2018/07/23							
0 PLACES ± 0.0		APPR: FSMITH 2018/08/27			700580001-SD				
DRAFT WHERE APPLICABLE MUST REMAIN WITHIN DIMENSIONS		THIRD ANGLE PROJECTION							
		DRAWING			SEE TABLE				
		SERIES							
		B-SIZE 70058			1 OF 4				
		MATERIAL NUMBER							
		CUSTOMER							
		SHEET NUMBER							

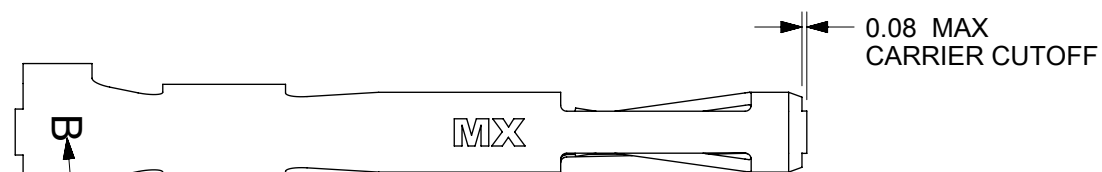
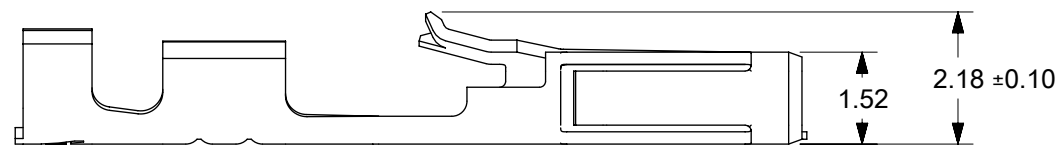
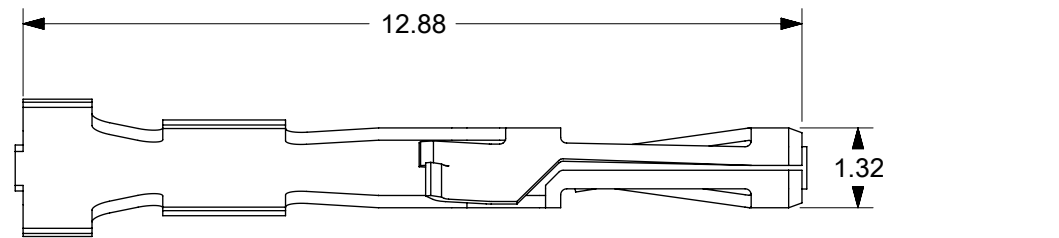

TERMINALS STAMPED WITH THE LETTER "B"
ACCEPT 32-36 AWG WIRE WITH A 0.64 MAX INSULATION DIA

NOTES:

1. MATERIAL: PHOSPHOR BRONZE
2. PLATING:
 207 = SELECT HARD GOLD: 0.38 MICROMETERS MIN.
 SELECT TIN: 2.0 MICROMETERS MIN BOTH OVER NICKEL
 206 = SELECT HARD GOLD: 0.75 MICROMETERS MIN.
 SELECT TIN: 2.0 MICROMETERS MIN BOTH OVER NICKEL
3. PRODUCT SPECIFICATION: TERMINALS CONFORM TO PS-70058 AND PS-70400 WHEN CRIMPED WITH MOLEX CRIMP TOOLS.
4. COSMETIC SPECIFICATION: PS-45499-002 CLASS B
5. TERMINAL FOR USE WITH HOUSING SERIES 70066 AND 70450
6. WIRE SPECIFICATION: TERMINALS STAMPED WITH THE LETTER:
 B = ACCEPTS 32-36 AWG STRANDED WIRE WITH A 0.64 MAX INSULATION DIA.

**TERMINALS ON THIS SHEET ARE FOR USE
WITH 32-36 AWG WIRE.
SEE SHEETS 1 AND 3 FOR OTHER WIRE SIZES**

PART NUMBER / ENGINEERING NO	PACKAGING	PLATING SEE NOTE 2	WIRE SIZE	MAX INSULATION DIA
16-02-0074 70058-0015	REEL	207 0.38 GOLD	32-36	0.64 DIA MAX
16-02-0085 70058-0017	REEL			
16-02-0101 70058-0217	LOOSE	206 0.75 GOLD		

(32-36 AWG WIRE)

THIS DRAWING CONTAINS INFORMATION THAT IS PROPRIETARY TO MOLEX ELECTRONIC TECHNOLOGIES, LLC AND SHOULD NOT BE USED WITHOUT WRITTEN PERMISSION									
DIMENSION UNITS	SCALE	CURRENT REV DESC: OBSOLETE PART NUMBER AS PER PCN#508517			molex				
mm	8:1								
GENERAL TOLERANCES (UNLESS SPECIFIED)		EC NO: 667105			SL CRIMP TERMINAL				
ANGULAR TOL ± °		DRWN: SUGEEB 2021/05/27							
4 PLACES ±		CHK'D: GGA 2021/06/29			PRODUCT CUSTOMER DRAWING				
3 PLACES ±		APPR: GGA 2021/06/29							
2 PLACES ± 0.15		INITIAL REVISION:			DOCUMENT NUMBER		DOC TYPE	DOC PART	REVISION
1 PLACE ± 0.25		DRWN: KSAMIEC 2018/07/23			700580001-SD		PSD	000	B1
0 PLACES ± 0.0		APPR: FSMITH 2018/08/27			MATERIAL NUMBER		CUSTOMER		SHEET NUMBER
DRAFT WHERE APPLICABLE MUST REMAIN WITHIN DIMENSIONS		THIRD ANGLE PROJECTION	DRAWING	SERIES	SEE TABLE	GENERAL MARKET		2 OF 4	

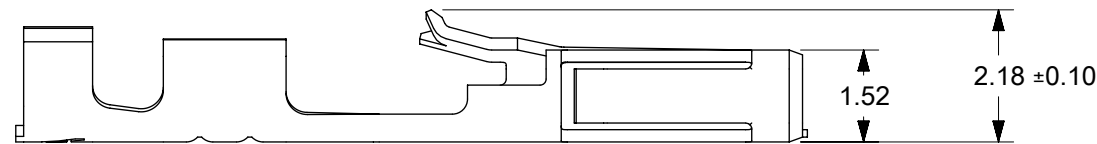
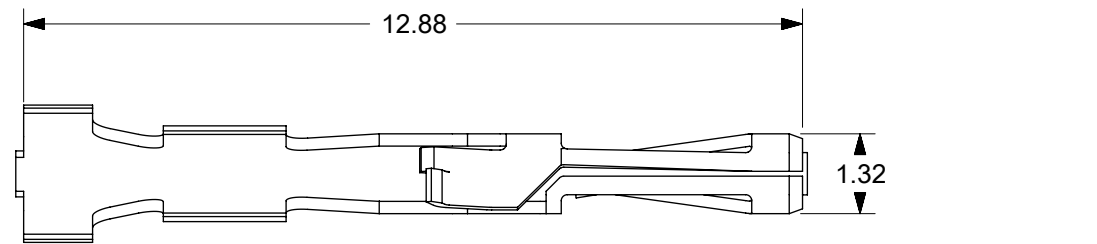

TERMINALS STAMPED WITH THE LETTER "C"
ACCEPT 22-24 AWG WIRE WITH A 1.63 MAX INSULATION DIA



NOTES:

- MATERIAL: PHOSPHOR BRONZE
- PLATING:
 - 124 = SELECT BRIGHT TIN: 3.75 MICROMETERS MIN OVER NICKEL
 - P124 = PREPLATED BRIGHT TIN: 3.75 MICROMETERS MIN OVER MATTE NICKEL (BARE EDGES)
 - 207 = SELECT HARD GOLD: 0.38 MICROMETERS MIN.
SELECT TIN: 2.0 MICROMETERS MIN BOTH OVER NICKEL
 - 206 = SELECT HARD GOLD: 0.75 MICROMETERS MIN.
SELECT TIN: 2.0 MICROMETERS MIN BOTH OVER NICKEL
- PRODUCT SPECIFICATION: TERMINALS CONFORM TO PS-70058 AND PS-70400 WHEN CRIMPED WITH MOLEX CRIMP TOOLS.
- COSMETIC SPECIFICATION: PS-45499-002 CLASS B
- TERMINAL FOR USE WITH HOUSING SERIES 70066 AND 70450
- WIRE SPECIFICATION: TERMINALS STAMPED WITH THE LETTER:
C = ACCEPTS 22-24 AWG STRANDED WIRE WITH A 1.63 MAX INSULATION DIA

TERMINALS ON THIS SHEET ARE FOR USE
WITH 22-24 AWG WIRE.
SEE SHEETS 1 AND 2 FOR OTHER WIRE SIZES

PART NUMBER / ENGINEERING NO:	PACKAGING	PLATING SEE NOTE 2	WIRE SIZE	MAX INSULATION DIA
16-02-0086 70058-0022	REEL	124 SELECT TIN	22-24 AWG	1.63 DIA MAX
16-02-0102 70058-0222	LOOSE			
70058-4086	REEL	124 OVERALL TIN		
16-02-0087 70058-0024	REEL	207 0.38 GOLD		
16-02-0103 70058-0224	LOOSE			
16-02-0088 70058-0026	REEL	206 0.75 GOLD		
16-02-0104 70058-0226	LOOSE			

(22-24 AWG WIRE)

THIS DRAWING CONTAINS INFORMATION THAT IS PROPRIETARY TO MOLEX ELECTRONIC TECHNOLOGIES, LLC AND SHOULD NOT BE USED WITHOUT WRITTEN PERMISSION									
DIMENSION UNITS	SCALE	CURRENT REV DESC: OBSOLETE PART NUMBER AS PER PCN#508517							
mm	8:1								
GENERAL TOLERANCES (UNLESS SPECIFIED)									
ANGULAR TOL	± °								
4 PLACES	±								
3 PLACES	±	EC NO: 667105 DRWN: SUGEEB 2021/05/27 CHK'D: GGA 2021/06/29 APPR: GGA 2021/06/29							
2 PLACES	± 0.15								
1 PLACE	± 0.25	INITIAL REVISION: DRWN: KSAMIEC 2018/07/23 APPR: FSMITH 2018/08/27							
0 PLACES	± 0.0								
DRAFT WHERE APPLICABLE MUST REMAIN WITHIN DIMENSIONS	THIRD ANGLE PROJECTION	DRAWING	SERIES	MATERIAL NUMBER	CUSTOMER	DOCUMENT NUMBER	DOC TYPE	DOC PART	REVISION
		B-SIZE	70058	SEE TABLE	GENERAL MARKET	700580001-SD	PSD	000	B1
									SHEET NUMBER 3 OF 4

LOOSE PACKED

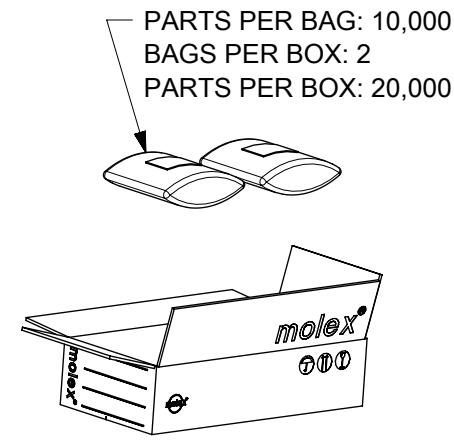

REEL PACKED

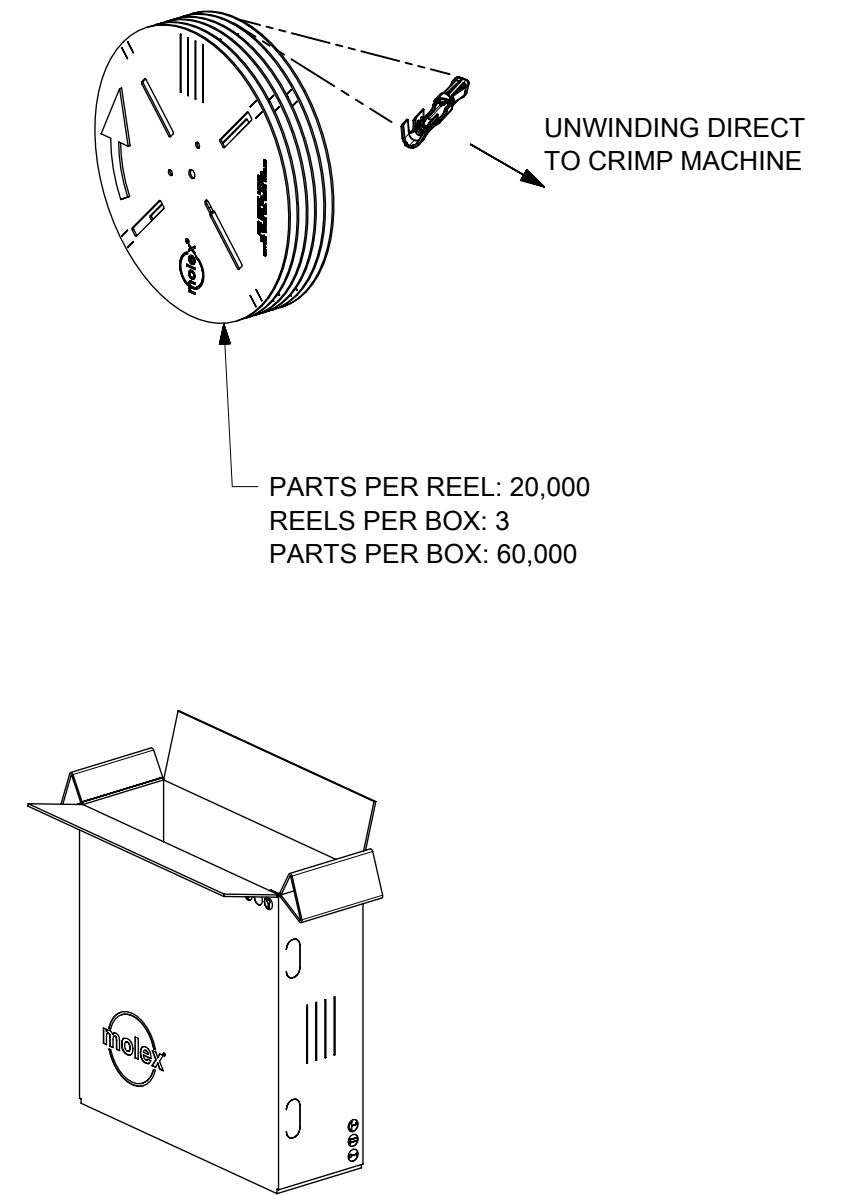

WHEN TERMINALS ARE FULLY INSERTED INTO THE HOUSINGS. THE TERMINAL'S LOCKING TANG SHOULD BE VISABLE IN THE HOUSING'S WINDOWS

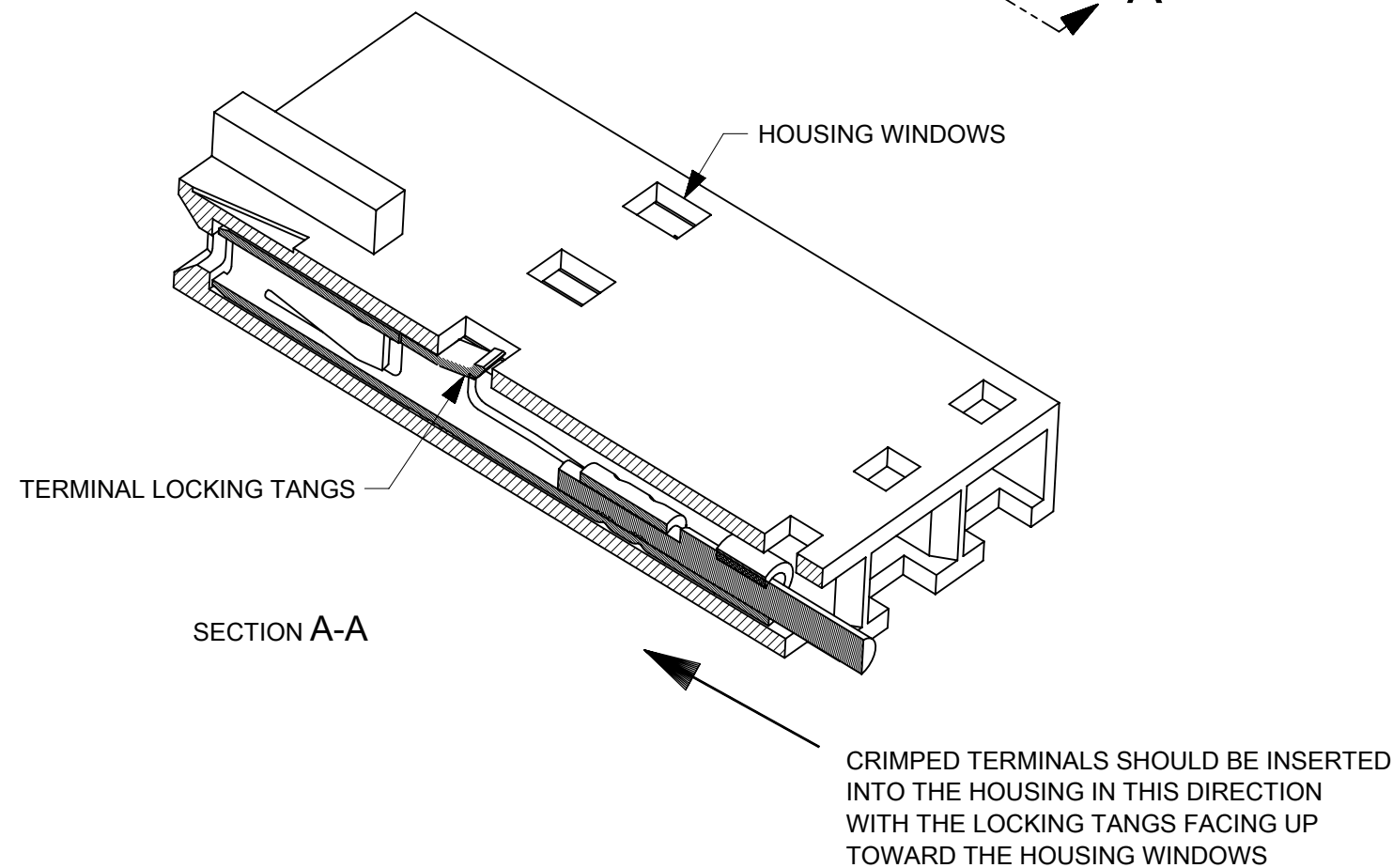
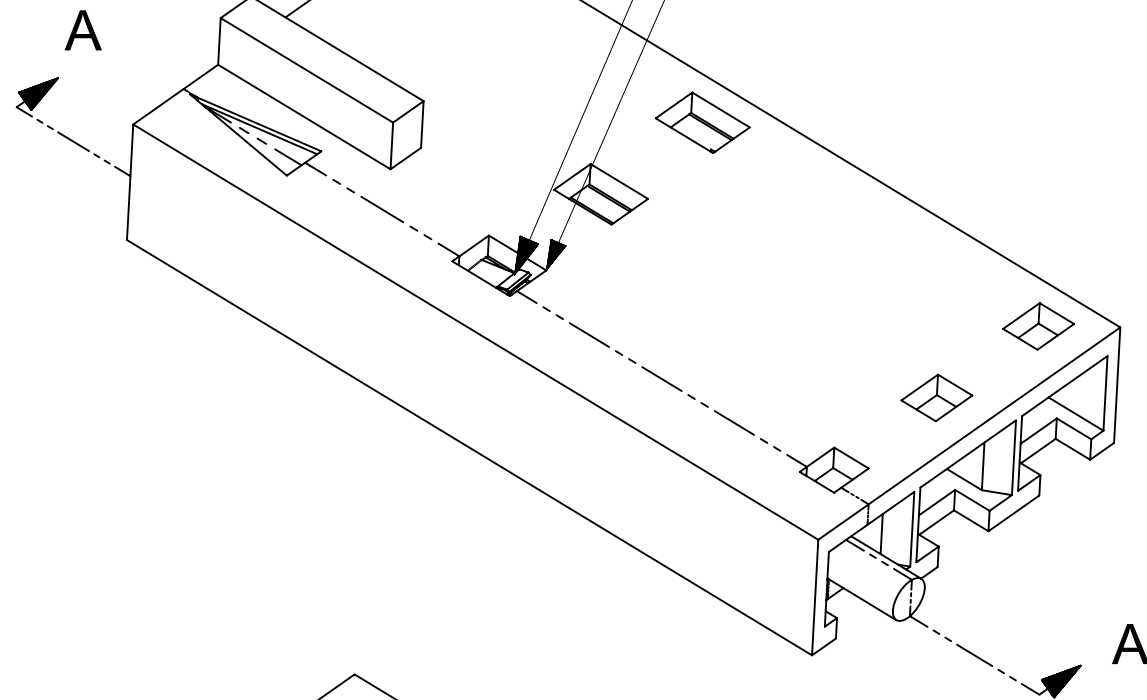

THIS DRAWING CONTAINS INFORMATION THAT IS PROPRIETARY TO MOLEX ELECTRONIC TECHNOLOGIES, LLC AND SHOULD NOT BE USED WITHOUT WRITTEN PERMISSION										
DIMENSION UNITS	SCALE	CURRENT REV DESC: OBSOLETE PART NUMBER AS PER PCN#508517			molex					
mm	1:15									
GENERAL TOLERANCES (UNLESS SPECIFIED)		EC NO: 667105			SL CRIMP TERMINAL					
ANGULAR TOL	± °	DRWN: SUGEEB 2021/05/27								
4 PLACES	±	CHK'D: GGA 2021/06/29			PRODUCT CUSTOMER DRAWING					
3 PLACES	±	APPR: GGA 2021/06/29								
2 PLACES	± 0.15	INITIAL REVISION:			DOCUMENT NUMBER					
1 PLACE	± 0.25	DRWN: KSAMIEC 2018/07/23								
0 PLACES	± 0.0	APPR: FSMITH 2018/08/27			700580001-SD			PSD	000	B1
DRAFT WHERE APPLICABLE MUST REMAIN WITHIN DIMENSIONS		THIRD ANGLE PROJECTION	DRAWING	SERIES	MATERIAL NUMBER	CUSTOMER		SHEET NUMBER		
			B-SIZE	70058	SEE TABLE	GENERAL MARKET		4 OF 4		