



产品编号 : [348855511](#)

Product Description : .635mm, 1.50mm,
Power CMX Connector, 55 Circuits, Right
Wire Output, Black Coding

系列号 : 34885

状态 : Active

Product Category : Connector Housings



文件和资源

图纸

[图纸 348855511_sd.pdf](#)

规格

[应用规格 AS-34885-002-001.pdf](#)

产物环境合规

合规

GADSL/IMDS	Compliant
China RoHS	
EU ELV	Compliant per 2000/53/EC
Low-Halogen Status	Low-Halogen per IEC 61249-2-21
REACH SVHC	Contains Lead monoxide per D(2023)3788-DC (14 Jun 2023)
EU RoHS	Compliant per EU 2015/863

多部分产品合规性声明

- Eu RoHS
- REACH SVHC
- Low-Halogen

多部分行业合规性文件

- IPC 1752A Class C
- IPC 1752A Class D
- Molex Product Compliance Declaration
- IEC-62474
- chemSHERPA (xml)

产品详情

常规

状态	活动
类别	Connector Housings
系列	34885
说明	.635mm, 1.50mm, Power CMX Connector, 55 Circuits, Right Wire Output, Black Coding
应用	Automotive, Power, Wire-to-Board
个评论	Current tested on 0.85mm ² wire for CTX64 and CTX150; 2A for CTX64, 10A for CTX150
更详细的技术信息	Sealed, hybrid, high-density, a new generation of CMC, suitable for rugged, powertrain applications in transportation market
产品系列	CMC and CMX Sealed, Hybrid, Modular Connectors
产品名称	CMX
UPC	889056357517

电气

每触点最大电流	10.0A, 2.0A
---------	-------------

物理

电路详图	35x0.64mm, 20x1.50mm terminals
电路数 (最多)	55
颜色-树脂	黑色
性别	Receptacle
符合灼热丝规范	否
插接极性	是
锁定插接部位	是
材料 - 树脂	Polyester
净重	40.342/g
行数	5
包装形式	Carton

面板安装式	否
间距 - 插配接口	2.50mm, 3.70mm
可堆叠的	否
运行温度范围	-40° to +120° C

可连接使用部件

描述	产品编号
CMC 0.635mm Blind Cavity Plug	/content/molex/molex-dot-com/cn/zh/products/product-page.html/643251010.html
CMC 1.50mm Blind Cavity Plug	/content/molex/molex-dot-com/cn/zh/products/product-page.html/643251023.html
CTX64 Female Terminals	<u>34803</u>
CTX150 Female Terminals	<u>34805</u>

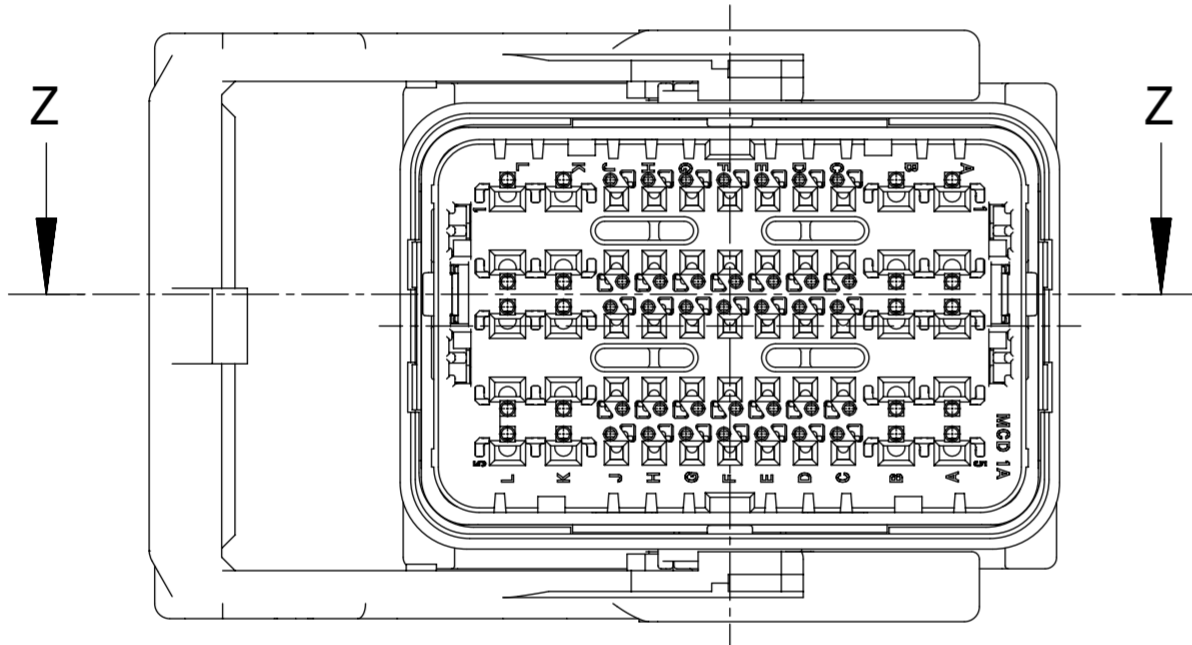
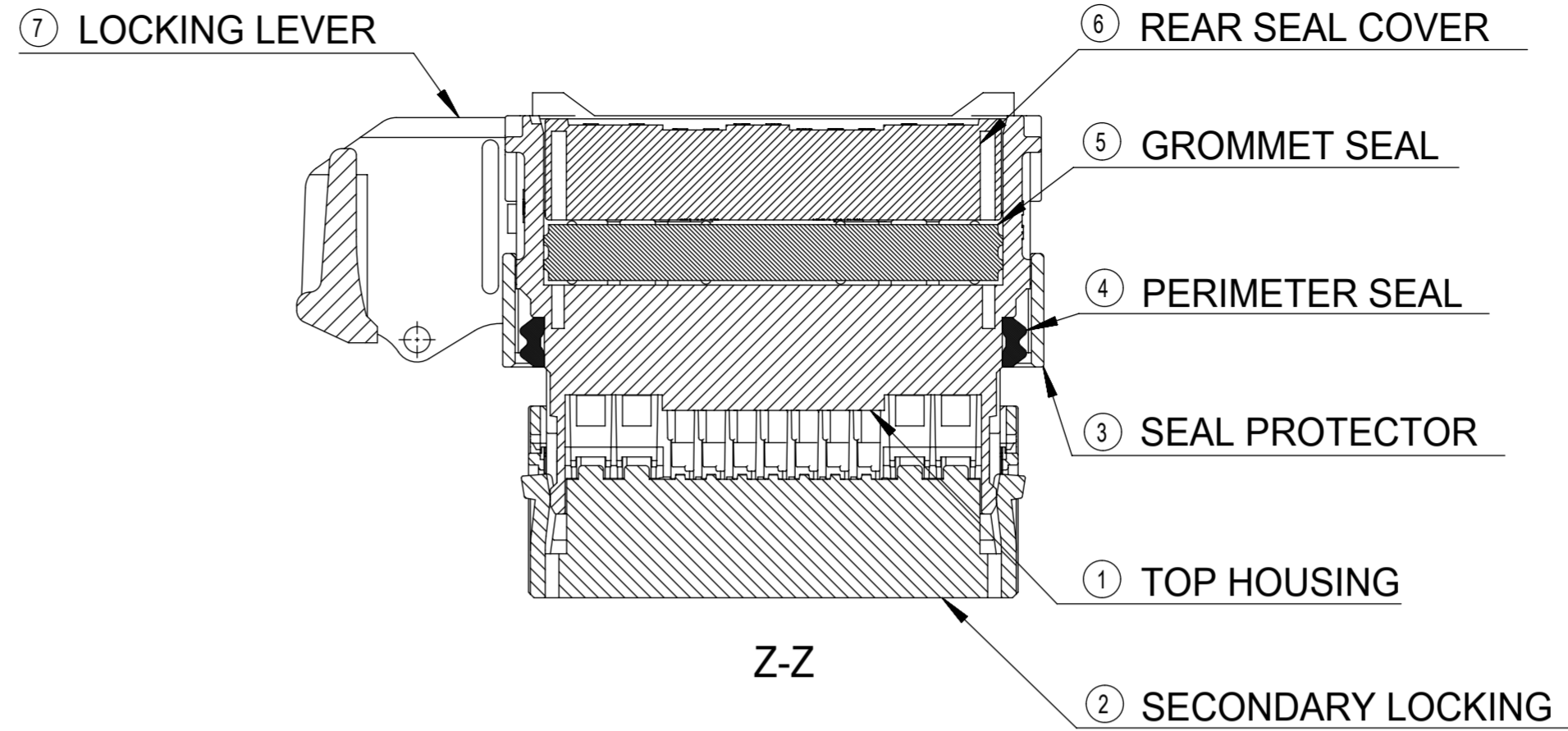
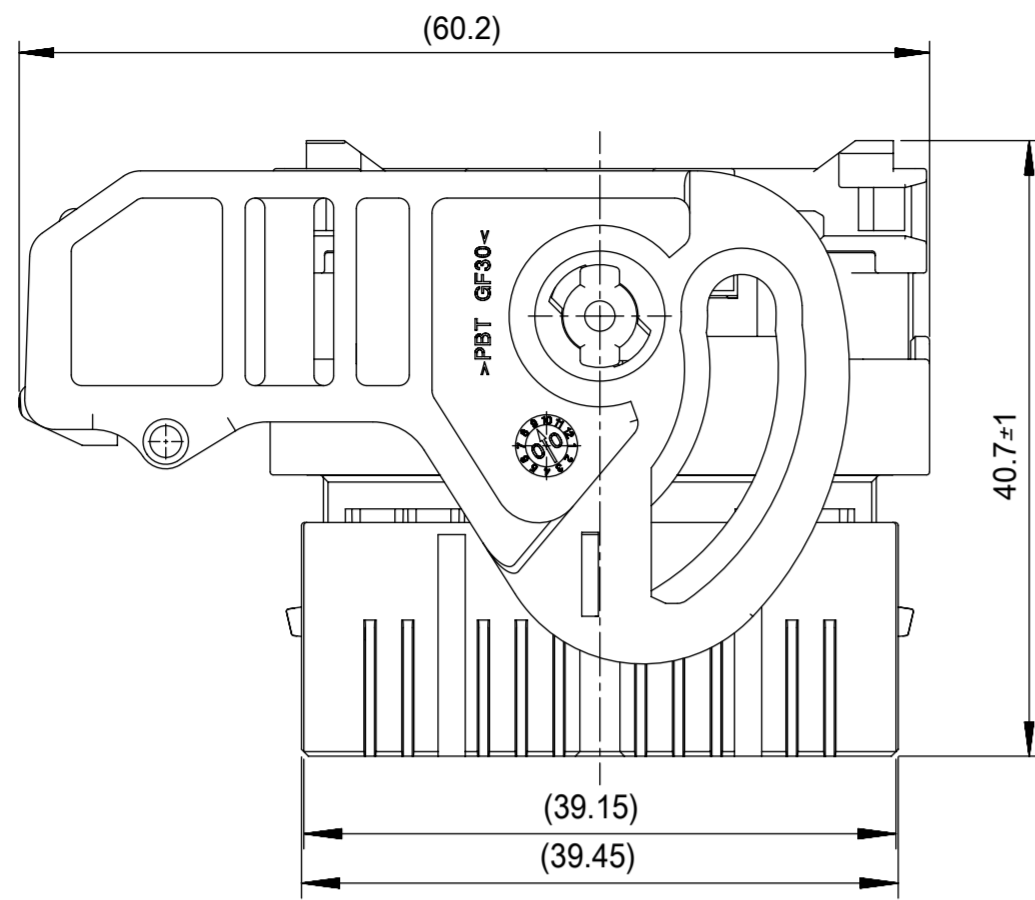

LOT MARKING : MATERIAL No. / DATE / SHIFT

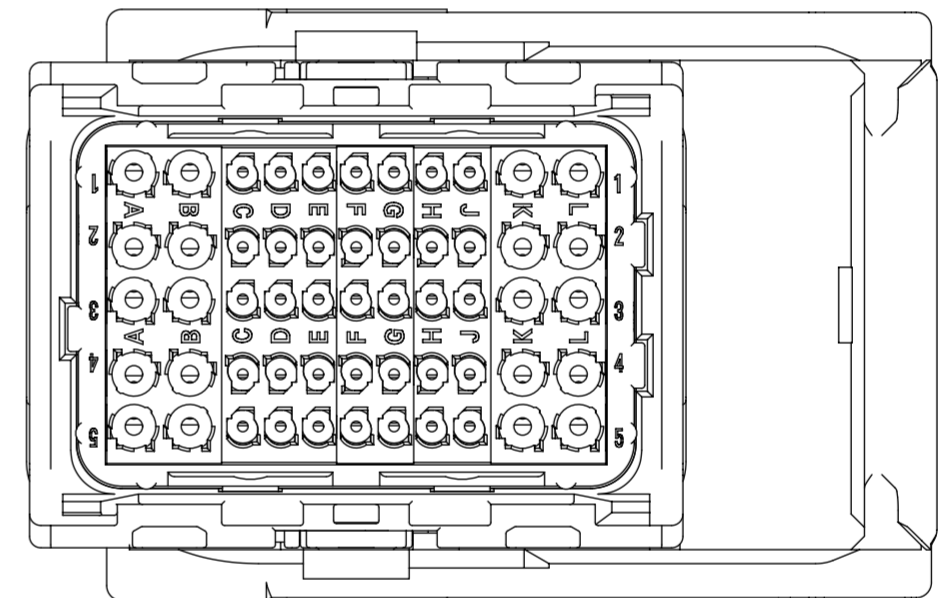
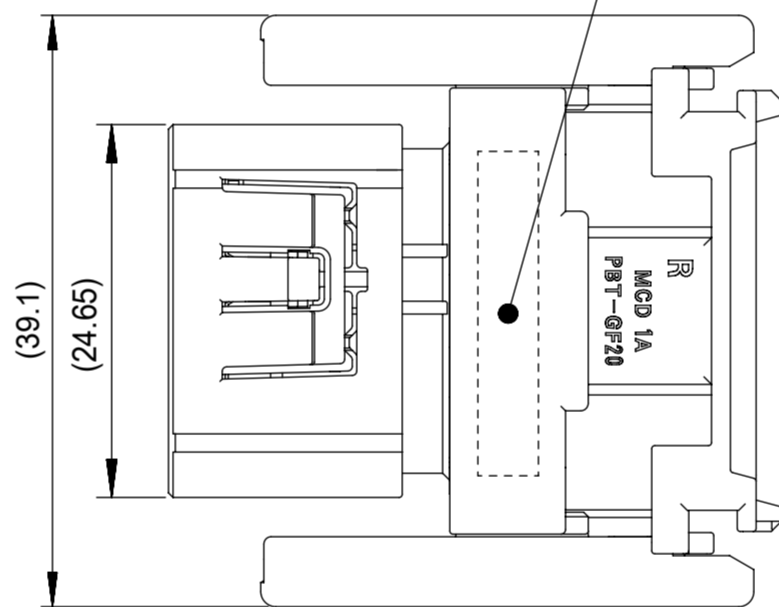

LEFT	34885-5522	BROWN	PRODUCTION
	34885-5512	BLACK	PRODUCTION
RIGHT	34885-5521	BROWN	PRODUCTION
	34885-5511	BLACK	PRODUCTION
WIRE OUTPUT(LEVER DIRECTION)	MATERIAL NO.	CODING	PRODUCT STATUS

① TOP HOUSING	PBT G.F.	BLACK
② SECONDARY LOCKING	PBT G.F.	BLACK/BROWN
③ SEAL PROTECTOR	PBT G.F.	BLACK
④ PERIMETER SEAL	SILICONE	RED
⑤ GROMMET SEAL	SILICONE	RUST RED
⑥ REAR SEAL COVER	PBT G.F.	BLACK
⑦ LOCKING LEVER	PBT G.F.	BLACK
PART NAME	MATERIAL	COLOR

THIS DRAWING CONTAINS INFORMATION THAT IS PROPRIETARY TO MOLEX ELECTRONIC TECHNOLOGIES, LLC AND SHOULD NOT BE USED WITHOUT WRITTEN PERMISSION

DIMENSION UNITS	SCALE	CURRENT REV DESC: REVISED		
mm	2:1	<p>molex</p> <p>CMX CONNECTOR 55WAY ASSY</p> <p>PRODUCT CUSTOMER DRAWING</p>		
GENERAL TOLERANCES (UNLESS SPECIFIED)				
ANGULAR TOL	± --- °			
4 PLACES	± ---			
3 PLACES	± ---			
2 PLACES	± ---	EC NO: 625053	2019/10/02	
1 PLACE	± ---	DRWN: KNAGAI02	2019/10/04	
0 PLACES	± ---	CHK'D: SANDO	2019/10/07	
DRAFT WHERE APPLICABLE MUST REMAIN WITHIN DIMENSIONS		APPR: TOSADA	2015/05/19	
THIRD ANGLE PROJECTION		INITIAL REVISION:	2015/09/10	
DRAWING		DRWN: PBOSQUAIN	2015/09/10	
SERIES		APPR: OPLESSIS		
A2-SIZE	34885	DOCUMENT NUMBER	DOC TYPE DOC PART REVISION	
SEE CHART	GENERAL MARKET	SD-34885-001	PSD 001 B	
MATERIAL NUMBER	CUSTOMER	SHEET NUMBER		
		1 OF 2		

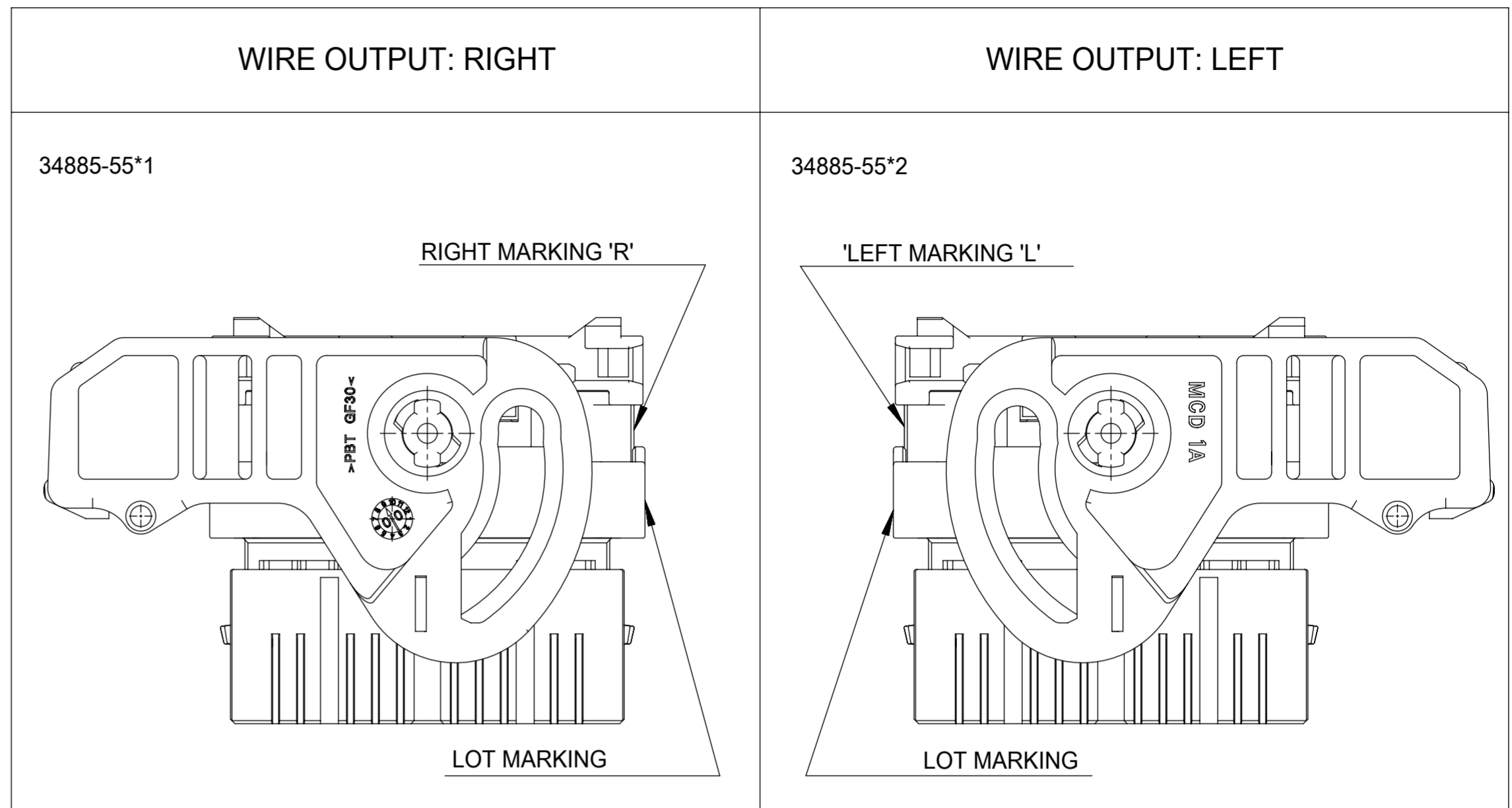
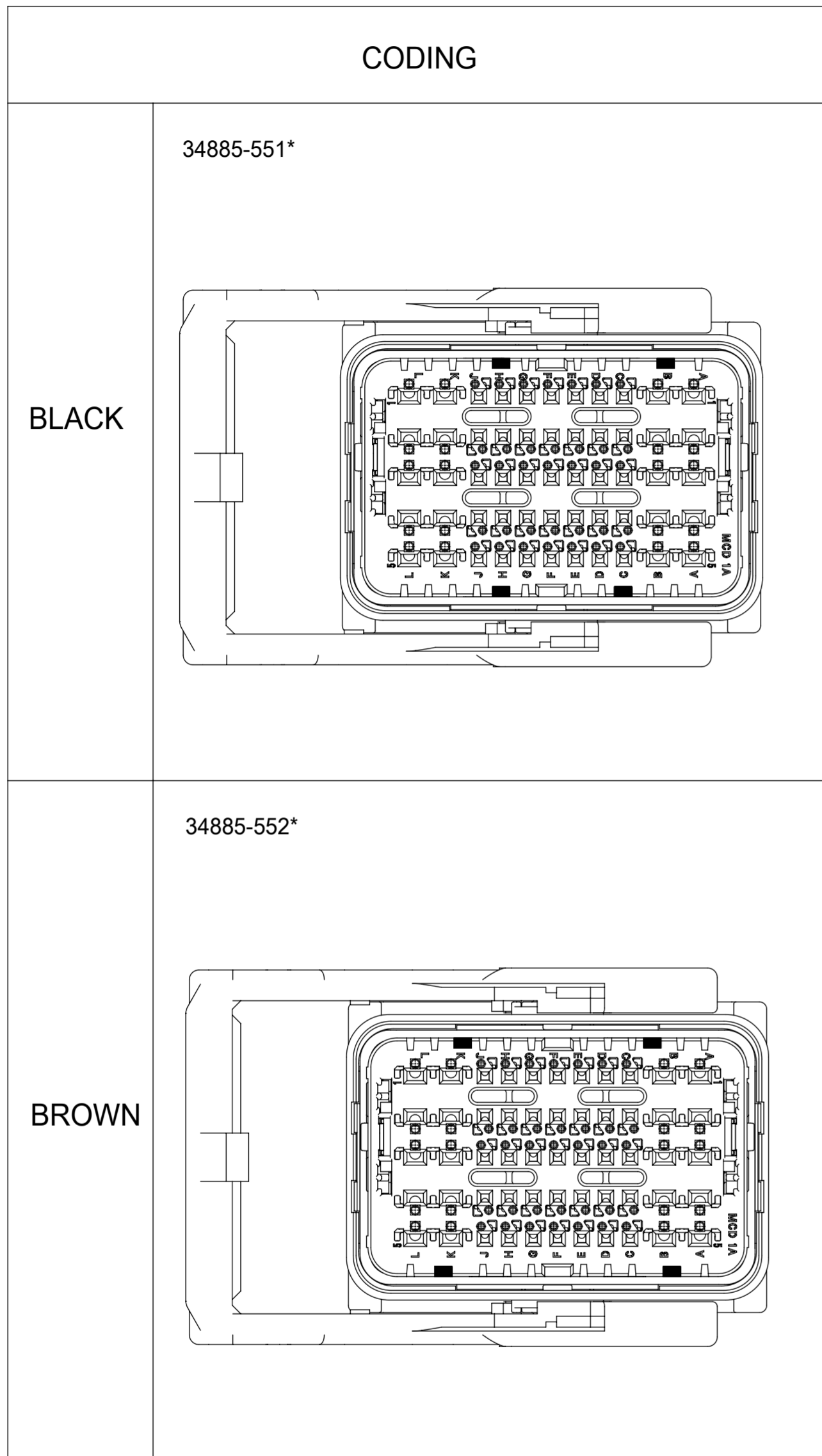

< APPLICABLE TERMINAL AND WIRE SIZE >

APPLICABLE TERMINAL	PART NO.	JASO WIRE SIZE		ISO WIRE SIZE	
		APPLICABLE WIRE SIZE	INSULATION DIAMETER (mm)	APPLICABLE WIRE SIZE	INSULATION DIAMETER (mm)
CTX64 TERMINAL	34803-3211	AVSS / CAVS 0.3sq	1.4 - 1.5	THIN WALL 0.35sq	1.25 - 1.4
	34803-3212	AVSS / CAVS 0.5 - 0.85sq	1.6 - 1.9	THIN WALL 0.5 - 0.75sq	1.4 - 1.9
CTX150 TERMINAL	34805-0112	AVSS / CAVS 0.85 - 1.25sq	1.8 - 2.2	THIN WALL 0.75 - 1sq	1.6 - 2.15
	34805-0113	AVSS / CAVS 1.25 - 2sq	2.1 - 2.7	THIN WALL 1.5 - 2sq	2.1 - 2.8

- NOTES :
- 1 - BROWN CODING SHOWN
 - 2 - APPLICABLE TERMINAL : SEE CHART
 - 3 - APPLICABLE WIRE CAP : 502730-0001
 - 4 - ELV AND RoHS COMPLIANT

THIS DRAWING CONTAINS INFORMATION THAT IS PROPRIETARY TO MOLEX ELECTRONIC TECHNOLOGIES, LLC AND SHOULD NOT BE USED WITHOUT WRITTEN PERMISSION									
DIMENSION UNITS	SCALE	CURRENT REV DESC: REVISED							
mm	2:1	<p>CMX CONNECTOR 55WAY ASSY</p> <p>PRODUCT CUSTOMER DRAWING</p>							
GENERAL TOLERANCES (UNLESS SPECIFIED)									
ANGULAR TOL	± --- °								
4 PLACES	± ---								
3 PLACES	± ---								
2 PLACES	± ---								
1 PLACE	± ---	EC NO: 625053	2019/10/02		<p>DOCUMENT NUMBER: SD-34885-001</p> <p>DOC TYPE: PSD</p> <p>DOC PART: 001</p> <p>REVISION: B</p>				
0 PLACES	± ---	DRWN: KNAGAI02	2019/10/04						
DRAFT WHERE APPLICABLE MUST REMAIN WITHIN DIMENSIONS		CHK'D: SANDO	2019/10/07						
THIRD ANGLE PROJECTION		APPR: TOSADA	2019/10/07						
DRAWING		INITIAL REVISION:		2015/05/19		MATERIAL NUMBER		CUSTOMER	
A2-SIZE		DRWN: PBOSQUAIN		2015/09/10		SEE SHEET 1		GENERAL MARKET	
SERIES		APPR: OPLESSIS		2015/09/10		CUSTOMER		SHEET NUMBER	
34885						GENERAL MARKET		2 OF 2	