

产品编号 : 39014047

Product Description : Mini-Fit Jr. Plug Housing, Single Row, 4 Circuits, UL 94V-0, without Panel Mounting Ears, Natural

系列号 : 5559

状态 : Active

Product Category : Connector Housings

工程编号 : 5559-04P3-210



文件和资源

图纸

图纸 039014047_sd.pdf

3D 模型和设计文件

3D模型 039014047_stp.zip

规格

应用规格 AS-5557-001-001.pdf

应用规格 55560001-AS-000.pdf

包装规格 PK-5559-003-001.pdf

产品规格 PS-45750-001-001.pdf

产品规格 PS-5556-001-001.pdf

测试摘要 TS-5556-002-001.pdf

测试摘要 55560010-TS-000.pdf

产物环境合规

合规

GADSL/IMDS	Not Relevant
China RoHS	
EU ELV	Compliant per 2000/53/EC
Low-Halogen Status	Low-Halogen per IEC 61249-2-21
REACH SVHC	Not Contained per D(2023)3788-DC (14 Jun 2023)
EU RoHS	Compliant per EU 2015/863

多部分产品合规性声明

- Eu RoHS
- REACH SVHC
- Low-Halogen

多部分行业合规性文件

- IPC 1752A Class C
- IPC 1752A Class D
- Molex Product Compliance Declaration
- IEC-62474
- chemSHERPA (xml)

欧盟 RoHS 合格证书

产品详情

常规

状态	活动
类别	Connector Housings
系列	5559
说明	Mini-Fit Jr. Plug Housing, Single Row, 4 Circuits, UL 94V-0, without Panel Mounting Ears, Natural
应用	Power, Wire-to-Board, Wire-to-Wire
个评论	Current = 13A max. per circuit when header is mated to a receptacle loaded with 45750 series terminals crimped to 16 AWG wire. See Molex product specification PS-45750-001 for additional current derating information.
产品系列	Mini-Fit Family Power Connectors
产品名称	Mini-Fit Jr.
UPC	756054855072

机构

CSA	LR19980
UL	E29179

物理

断开	否
----	---

电路数 (最多)	4
颜色-树脂	Natural
阻燃性	94V-0
性别	Plug
符合灼热丝规范	否
插接极性	无
锁定插接部位	是
材料 - 树脂	Nylon
净重	1.458/g
行数	1
包装形式	Bag
面板安装式	否
间距 - 插配接口	4.20mm
间距 - 终端界面	4.20mm
有极性的插配件	是
可堆叠的	否
运行温度范围	-40° to +105° C

进程

无铅	不适用
----	-----

可配插/可连接使用的产品

可配插部件

描述	产品编号
Mini-Fit Jr. Receptacle Housing, Single Row, 4 Circuits, UL 94V-0, Natural	<u>0039014041</u>
Mini-Fit TPA2-to-Mini-Fit TPA2 Off-the-Shelf (OTS) Cable Assemblies	<u>145135</u>

可连接使用部件

描述	产品编号
Pre-Crimped Lead Mini-Fit Male-to-Mini-Fit Male, Tin (Sn) Plating, 150.00mm Length, 18 AWG, Red	<u>/content/molex/molex-dot-com/cn/zh/products/product-page.html/797580005.html</u>

Pre-Crimped Lead Mini-Fit Male-to-Mini-Fit Male, Tin (Sn) Plating, 300.00mm Length, 18 AWG, Red	/content/molex/molex-dot-com/cn/zh/products/product-page.html/797580013.html
Mini-Fit Male Crimp Terminals	<u>5558</u>
Mini-Fit Plus Male Crimp Terminals	<u>46012</u>
Mini-Fit Jr. Crimp Grounding Terminals	<u>30490</u>
Mini-Fit Jr. Hermaphroditic Backshells	<u>204723</u>

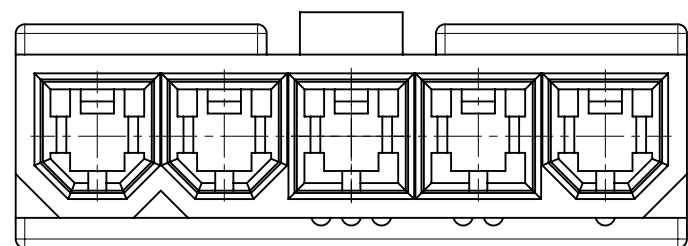
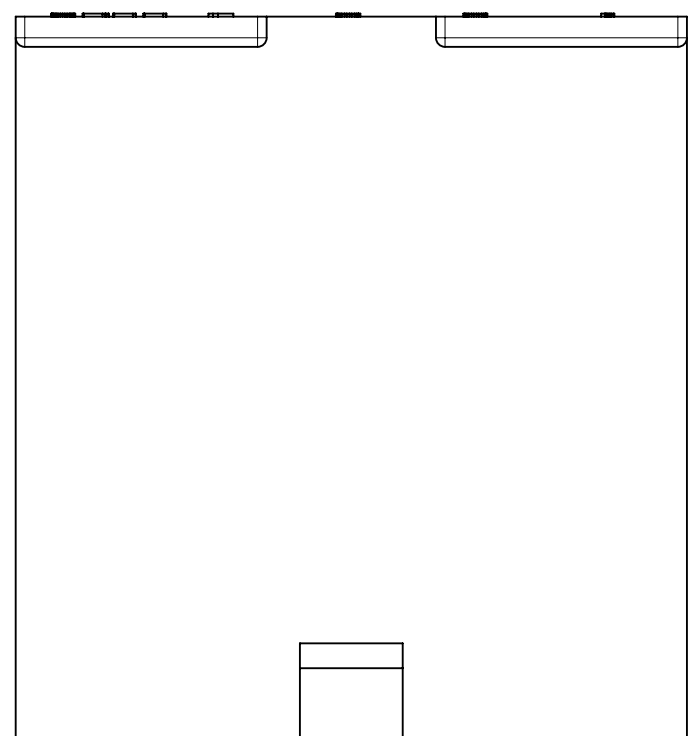
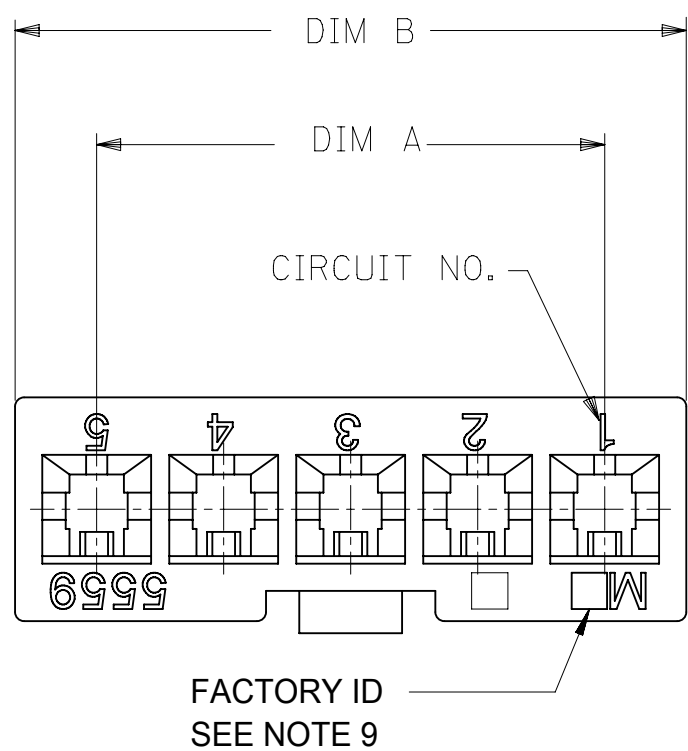

5 CKT WITHOUT
MOUNTING EARS SHOWN

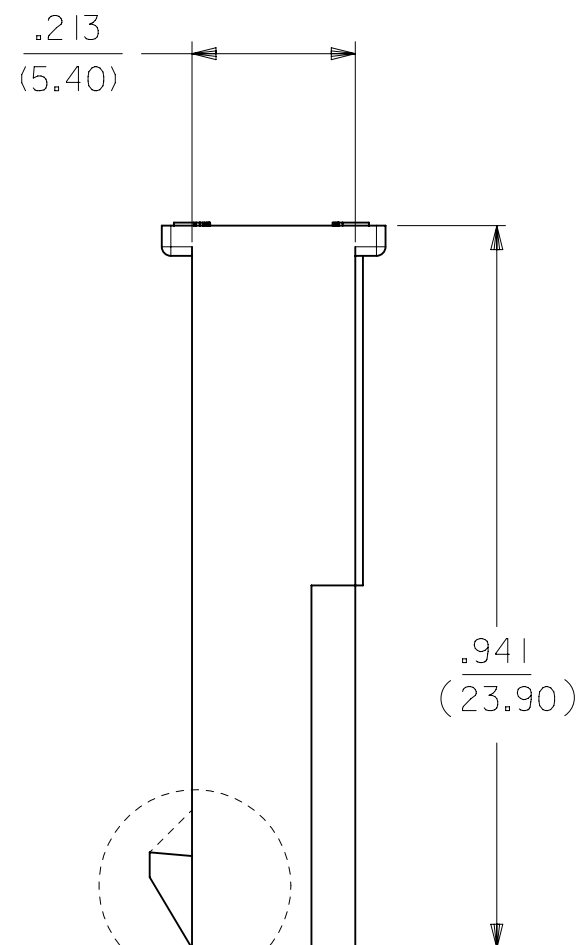
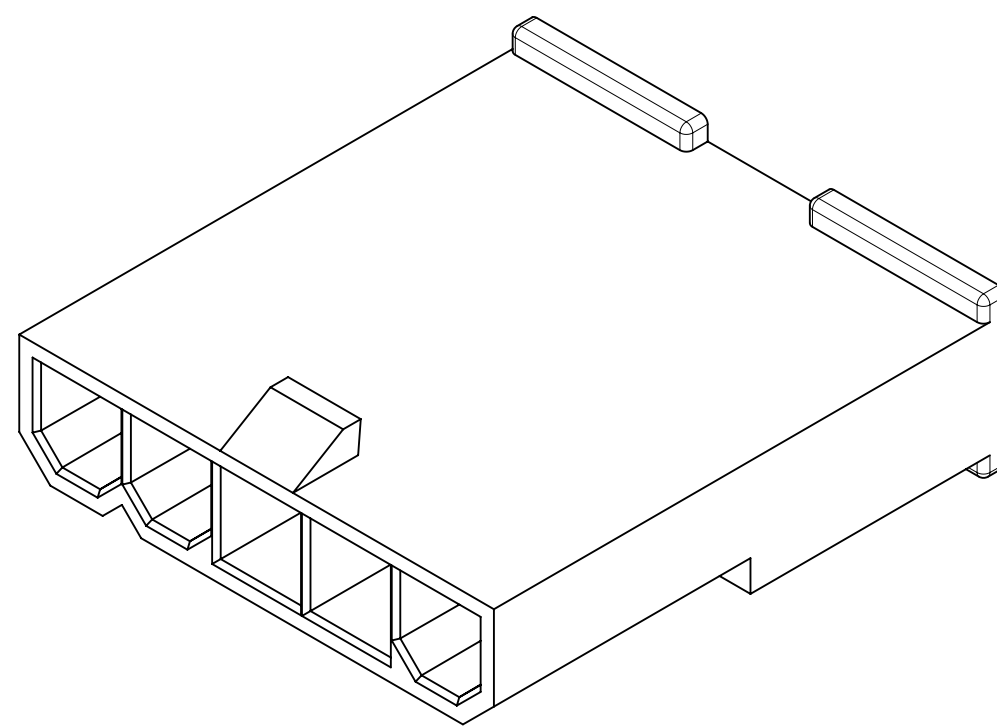

LOCK OPTION:

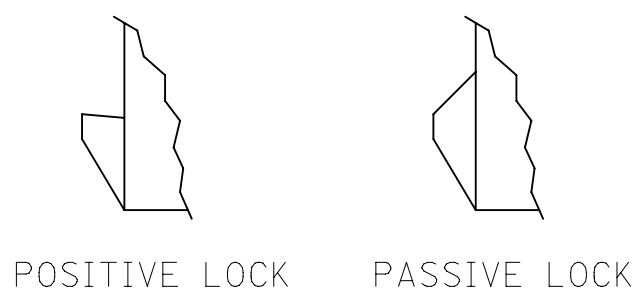

CKT SIZE	DIM A	DIM B	DIM C	DIM D
2	.165 (4.20)	.378 (9.60)	.394 (10.00)	.591 (15.00)
4	.496 (12.60)	.709 (18.00)	.724 (18.40)	.921 (23.40)
5	.661 (16.80)	.874 (22.20)	.890 (22.60)	1.087 (27.60)
6	.827 (21.00)	1.039 (26.40)	1.055 (26.80)	1.252 (31.80)
7	.992 (25.20)	1.205 (30.60)	1.220 (31.00)	1.417 (36.00)
8	1.157 (29.40)	1.370 (34.80)	1.386 (35.20)	1.583 (40.20)
9	1.323 (33.60)	1.535 (39.00)	1.551 (39.40)	1.748 (44.40)
10	1.488 (37.80)	1.701 (43.20)	1.717 (43.60)	1.913 (48.60)
11	1.654 (42.00)	1.866 (47.40)	1.882 (47.80)	2.079 (52.80)
12	1.819 (46.20)	2.031 (51.60)	2.047 (52.00)	2.244 (57.00)

NOTES:

- MATERIAL: BLANK=NYLON 6/6, UL 94V-2, COLOR: NATURAL.
210=NYLON 6/6, UL 94V-0, COLOR: NATURAL.
400=NYLON 6/6, UL 94 V-0, COLOR: BLACK.
- FINISH: NOTE APPLICABLE
- PRODUCT SPECIFICATION: PS-5556-001
- PACKAGING SPECIFICATION: BULK PER PK-5559-003
- THIS PART MATES WITH RECEPTACLE NO. 5557.
- THIS PART IS FOR USE WITH MOLEX MALE TERMINAL NO. 5558-*
- PANEL MOUNT VERSION IS FOR USE WITH .031/.079/(0.80/2.00) THICK PANELS.
- PANEL SHOULD BE PUNCHED IN THE DIRECTION OF CONNECTOR INSERTION.
- FACTORY ID MAY BE LOCATED ON EARS.
- THIS PART CONFORMS TO CLASS B REQUIREMENTS OF COSMETIC SPECIFICATION PS-45499-002.
- PART IS NOT DESIGNED FOR CURRENT SHARING.
- PARTS ARE NOT TO BE MATED OR UNMATED WHILE CIRCUITS ARE LIVE.
- WIRES ARE TO BE DRESSED IN SUCH A MANNER TO ALLOW THE TERMINALS TO FLOAT FREELY IN THE POCKET.

THIS DRAWING CONTAINS INFORMATION THAT IS PROPRIETARY TO MOLEX ELECTRONIC TECHNOLOGIES, LLC AND SHOULD NOT BE USED WITHOUT WRITTEN PERMISSION									
DIMENSION UNITS IN/MM		SCALE 1:1		CURRENT REV DESC: REMOVED OBSOLETE PART NUMBER AS PER PCN#511918				molex	
GENERAL TOLERANCES (UNLESS SPECIFIED)				EC NO: 703993					
		MM	INCH	DRWN: SUGEEB		2022/04/07		MINI-FIT JR. SERIES PLUG (SINGLE ROW)	
4 PLACES ±				CHK'D: GGA		2022/04/25			
3 PLACES ±			± 0.01	APPR: GGA		2022/04/25		PRODUCT CUSTOMER DRAWING	
2 PLACES ±		0.25	± 0.015	INITIAL REVISION:					
1 PLACE ±		0.38		DRWN: KSS		1989/02/19		DOCUMENT NUMBER	
0 PLACES ±				APPR: FSMITH		2011/03/10		55590002-SD	
ANGULAR TOL ±		0.5 °		THIRD ANGLE PROJECTION		DRAWING		SERIES	
DRAFT WHERE APPLICABLE MUST REMAIN WITHIN DIMENSIONS				C-SIZE		5559		MATERIAL NUMBER	
								CUSTOMER	
								GENERAL MARKET	
								SHEET NUMBER	
								1 OF 3	

THIS DRAWING REPLACES DRAWING SD-5559-NLP+

DOCUMENT STATUS	P1	RELEASE DATE	2022/04/25	07:01:54
-----------------	----	--------------	------------	----------

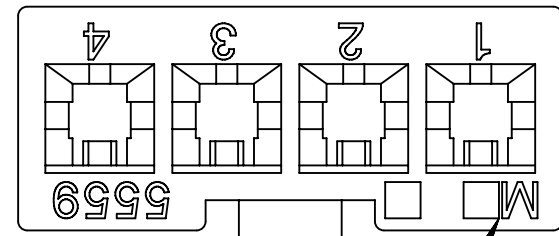

FACTORY ID
SEE NOTE 9

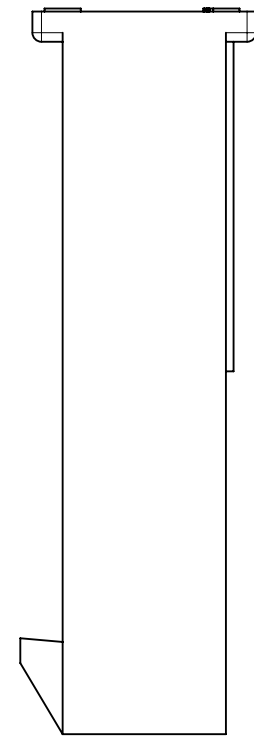
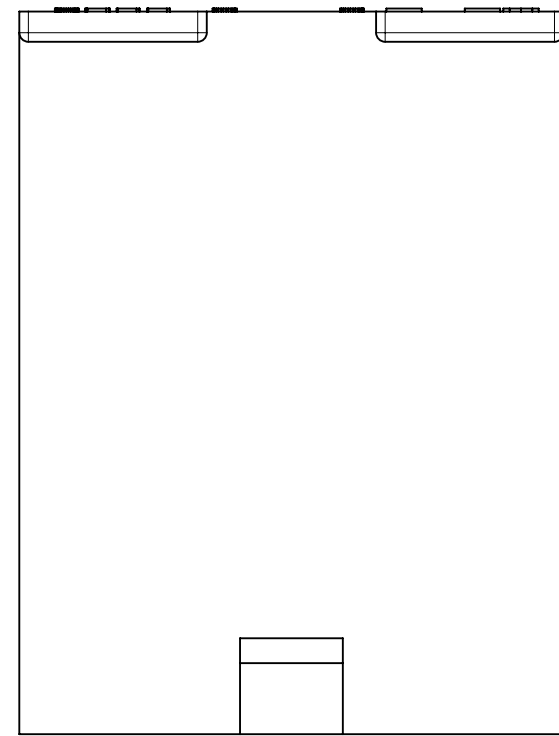

SEE NOTE 9

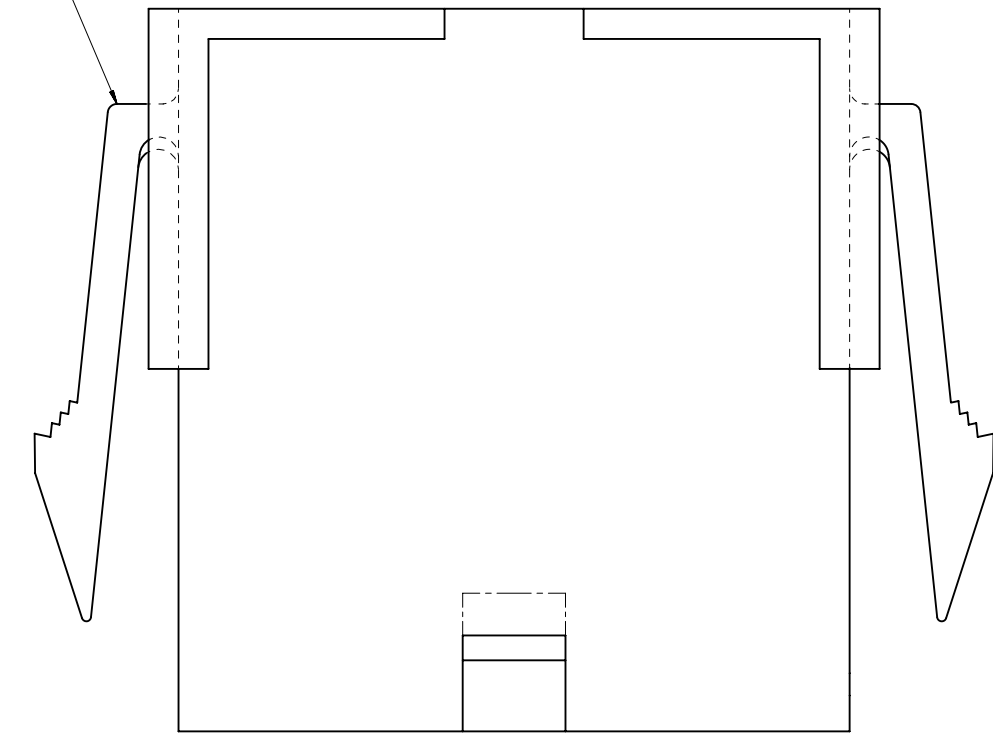

WITH MOUNTING EARS

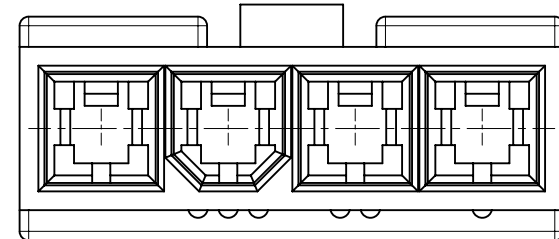
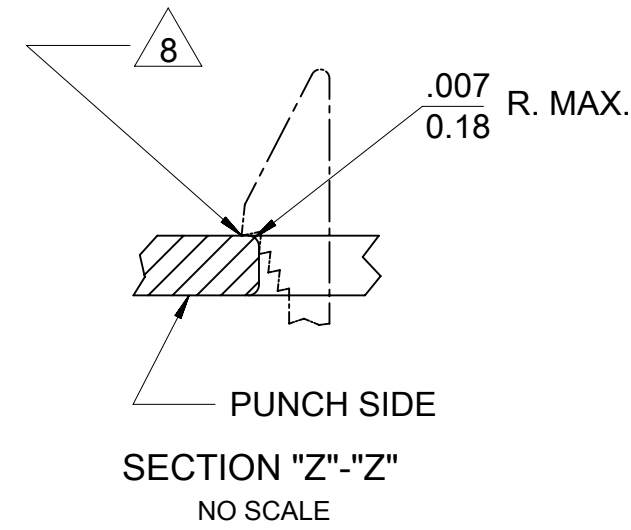

4 CKT WITHOUT
MOUNTING EARS SHOWN

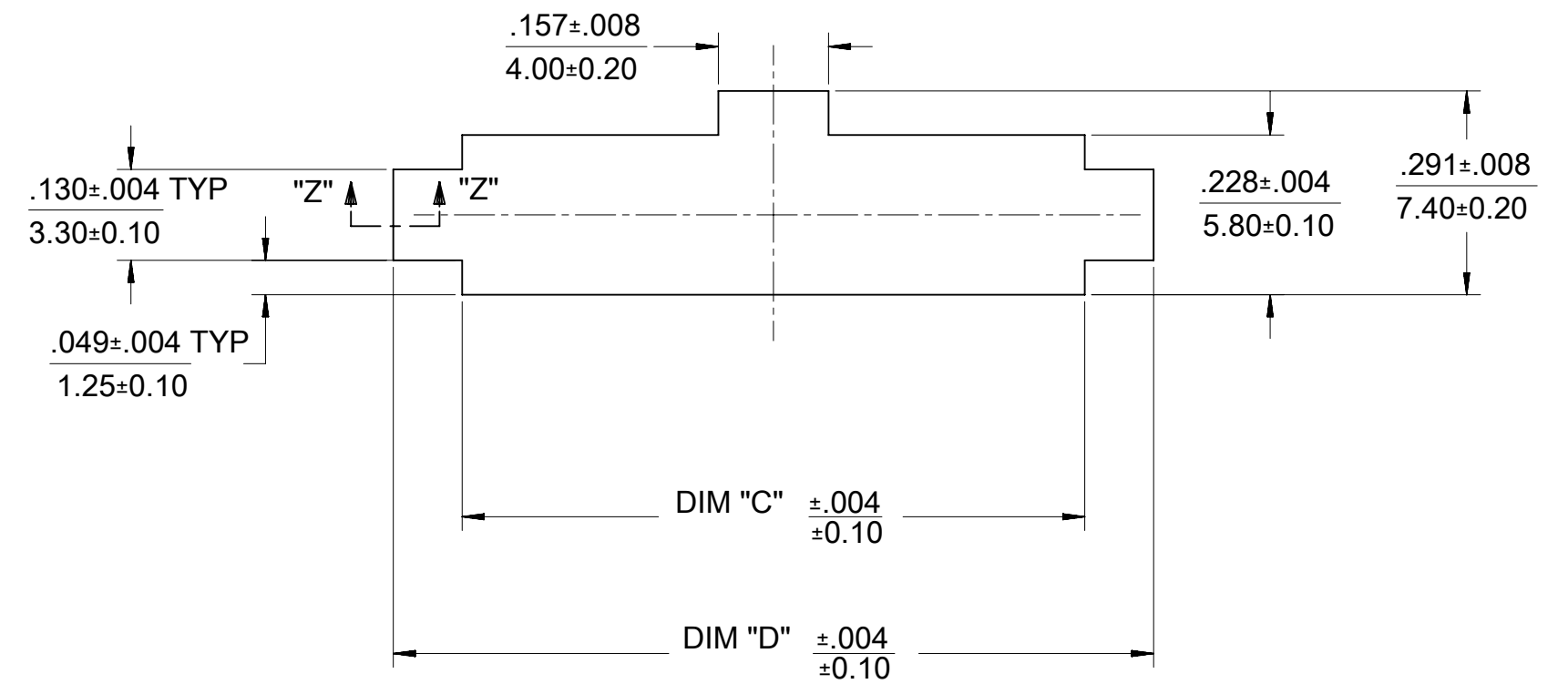

RECOMMENDED PANEL CUT-OUT
(SEE NOTE 7 & 8)

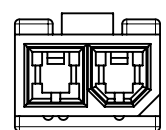

2 CIRCUIT

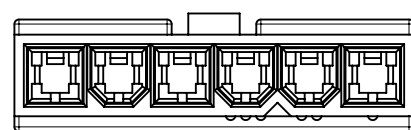

6 CIRCUIT

POLARIZATION

THIS DRAWING CONTAINS INFORMATION THAT IS PROPRIETARY TO MOLEX ELECTRONIC TECHNOLOGIES, LLC AND SHOULD NOT BE USED WITHOUT WRITTEN PERMISSION

DIMENSION UNITS IN/MM		SCALE 1:1		CURRENT REV DESC: REMOVED OBSOLETE PART NUMBER AS PER PCN#511918		molex							
GENERAL TOLERANCES (UNLESS SPECIFIED)				EC NO: 703993						MINI-FIT JR. SERIES PLUG (SINGLE ROW)			
4 PLACES		±	±	DRWN: SUGEEB		2022/04/07		PRODUCT CUSTOMER DRAWING					
3 PLACES		±	± 0.01	CHK'D: GGA		2022/04/25						DOCUMENT NUMBER 55590002-SD	
2 PLACES		± 0.25	± 0.015	APPR: GGA		2022/04/25		DOC TYPE PSD		DOC PART 000			
1 PLACE		± 0.38	±	INITIAL REVISION:		1989/02/19		MATERIAL NUMBER SEE TABLE					
0 PLACES		±	±	DRWN: KSS		2011/03/10						CUSTOMER GENERAL MARKET	
ANGULAR TOL		± 0.5 °		APPR: FSMITH		DRAWING C-SIZE		SERIES 5559					
DRAFT WHERE APPLICABLE MUST REMAIN WITHIN DIMENSIONS				THIRD ANGLE PROJECTION		DRAWING C-SIZE		SERIES 5559					



THIS DRAWING REPLACES DRAWING SD-5559-NLP+

DOCUMENT STATUS	P1	RELEASE DATE	2022/04/25	07:01:54
-----------------	----	--------------	------------	----------

12	11	10	9	8	7	
TOOLED	PART NO	ENG NO	CKT SIZE	MOUNTING OPTION	LOCK OPTION	MATERIAL SEE NOTE I
YES	46999-0655	5559-02P2	2	W/EARS	POSITIVE	94V-2
YES	46999-0656	5559-02P3	2	W/O EAR	POSITIVE	94V-2
YES	46999-0657	5559-02P2-2 I0	2	W/EARS	POSITIVE	94V-0
YES	46999-0658	5559-02P3-2 I0	2	W/O EAR	POSITIVE	94V-0
YES	46999-0884	5559-02P2-400	2	WEARS	POSITIVE	94V-0 BLACK
YES	46999-0885	5559-02P3-400	2	W/O EAR	POSITIVE	94V-0 BLACK
YES	39-01-4046	5559-04P3	4	W/O EAR	POSITIVE	94V-2
YES	39-01-4043	5559-04P2-2 I0	4	W/EARS	POSITIVE	94V-0
YES	39-01-4047	5559-04P3-2 I0	4	W/O EAR	POSITIVE	94V-0
YES	46999-0561	5559-04P3-400	4	W/O EAR	POSITIVE	94V-0 BLACK
YES	39-01-4052	5559-05P2	5	W/EARS	POSITIVE	94V-2
YES	39-01-4056	5559-05P3	5	W/O EAR	POSITIVE	94V-2
YES	39-01-4053	5559-05P2-2 I0	5	W/EARS	POSITIVE	94V-0
YES	39-01-4057	5559-05P3-2 I0	5	W/O EAR	POSITIVE	94V-0
YES	50-30-4446	5559-05P3-400	5	W/O EAR	POSITIVE	94V-0 BLACK
YES	39-01-4062	5559-06P2	6	W/EARS	POSITIVE	94V-2
YES	39-01-4066	5559-06P3	6	W/O EAR	POSITIVE	94V-2
YES	46999-0886	5559-06P2-400	6	WEARS	POSITIVE	94V-0 BLACK
YES	46999-0887	5559-06P3-400	6	W/O EAR	POSITIVE	94V-0 BLACK
YES	39-01-4063	5559-06P2-2 I0	6	W/EARS	POSITIVE	94V-0
YES	39-01-4067	5559-06P3-2 I0	6	W/O EAR	POSITIVE	94V-0
NO	39-01-4072	5559-07P2	7	W/EARS	POSITIVE	94V-2
NO	39-01-4076	5559-07P3	7	W/O EAR	POSITIVE	94V-2
NO	39-01-4073	5559-07P2-2 I0	7	W/EARS	POSITIVE	94V-0
NO	39-01-4077	5559-07P3-2 I0	7	W/O EAR	POSITIVE	94V-0
NO	39-01-4082	5559-08P2	8	W/EARS	POSITIVE	94V-2
NO	39-01-4086	5559-08P3	8	W/O EAR	POSITIVE	94V-2
NO	39-01-4083	5559-08P2-2 I0	8	W/EARS	POSITIVE	94V-0
NO	39-01-4087	5559-08P3-2 I0	8	W/O EAR	POSITIVE	94V-0
NO	39-01-4092	5559-09P2	9	W/EARS	POSITIVE	94V-2
NO	39-01-4096	5559-09P3	9	W/O EAR	POSITIVE	94V-2
NO	39-01-4093	5559-09P2-2 I0	9	W/EARS	POSITIVE	94V-0
NO	39-01-4097	5559-09P3-2 I0	9	W/O EAR	POSITIVE	94V-0
NO	39-01-4102	5559-10P2	10	W/EARS	POSITIVE	94V-2
NO	39-01-4106	5559-10P3	10	W/O EAR	POSITIVE	94V-2
NO	39-01-4103	5559-10P2-2 I0	10	W/EARS	POSITIVE	94V-0
NO	39-01-4107	5559-10P3-2 I0	10	W/O EAR	POSITIVE	94V-0
NO	39-01-4112	5559-11P2	11	W/EARS	POSITIVE	94V-2
NO	39-01-4116	5559-11P3	11	W/O EAR	POSITIVE	94V-2
NO	39-01-4113	5559-11P2-2 I0	11	W/EARS	POSITIVE	94V-0
NO	39-01-4117	5559-11P3-2 I0	11	W/O EAR	POSITIVE	94V-0
NO	39-01-4122	5559-12P2	12	W/EARS	POSITIVE	94V-2
NO	39-01-4126	5559-12P3	12	W/O EAR	POSITIVE	94V-2
NO	39-01-4123	5559-12P2-2 I0	12	W/EARS	POSITIVE	94V-0
NO	39-01-4127	5559-12P3-2 I0	12	W/O EAR	POSITIVE	94V-0

6	5	4	3	2	1	
TOOLED	PART NO	ENG NO	CKT SIZE	MOUNTING OPTION	LOCK OPTION	MATERIAL SEE NOTE I
NO	NO E.D.P.	5559-04P4	4	W/EARS	PASSIVE	94V-2
NO	NO E.D.P.	5559-04P5	4	W/O EAR	PASSIVE	94V-2
NO	NO E.D.P.	5559-04P4-2 I0	4	W/EARS	PASSIVE	94V-0
NO	NO E.D.P.	5559-04P5-2 I0	4	W/O EAR	PASSIVE	94V-0
NO	NO E.D.P.	5559-05P5-2 I0	5	W/O EAR	PASSIVE	94V-0
NO	NO E.D.P.	5559-05P5-400	5	W/O EAR	PASSIVE	94V-0 BLACK
NO	NO E.D.P.	5559-06P4	6	W/EARS	PASSIVE	94V-2
NO	NO E.D.P.	5559-06P5	6	W/O EAR	PASSIVE	94V-2
NO	NO E.D.P.	5559-06P4-2 I0	6	W/EARS	PASSIVE	94V-0
NO	NO E.D.P.	5559-06P5-2 I0	6	W/O EAR	PASSIVE	94V-0
NO	NO E.D.P.	5559-07P4	7	W/EARS	PASSIVE	94V-2
NO	NO E.D.P.	5559-07P5	7	W/O EAR	PASSIVE	94V-2
NO	NO E.D.P.	5559-07P4-2 I0	7	W/EARS	PASSIVE	94V-0
NO	NO E.D.P.	5559-07P5-2 I0	7	W/O EAR	PASSIVE	94V-0
NO	NO E.D.P.	5559-08P4	8	W/EARS	PASSIVE	94V-2
NO	NO E.D.P.	5559-08P5	8	W/O EAR	PASSIVE	94V-2
NO	NO E.D.P.	5559-08P4-2 I0	8	W/EARS	PASSIVE	94V-0
NO	NO E.D.P.	5559-08P5-2 I0	8	W/O EAR	PASSIVE	94V-0
NO	NO E.D.P.	5559-09P4	9	W/EARS	PASSIVE	94V-2
NO	NO E.D.P.	5559-09P5	9	W/O EAR	PASSIVE	94V-2
NO	NO E.D.P.	5559-09P4-2 I0	9	W/EARS	PASSIVE	94V-0
NO	NO E.D.P.	5559-09P5-2 I0	9	W/O EAR	PASSIVE	94V-0
NO	NO E.D.P.	5559-10P4	10	W/EARS	PASSIVE	94V-2
NO	NO E.D.P.	5559-10P5	10	W/O EAR	PASSIVE	94V-2
NO	NO E.D.P.	5559-10P4-2 I0	10	W/EARS	PASSIVE	94V-0
NO	NO E.D.P.	5559-10P5-2 I0	10	W/O EAR	PASSIVE	94V-0
NO	NO E.D.P.	5559-11P4	11	W/EARS	PASSIVE	94V-2
NO	NO E.D.P.	5559-11P5	11	W/O EAR	PASSIVE	94V-2
NO	NO E.D.P.	5559-11P4-2 I0	11	W/EARS	PASSIVE	94V-0
NO	NO E.D.P.	5559-11P5-2 I0	11	W/O EAR	PASSIVE	94V-0
NO	NO E.D.P.	5559-12P4	12	W/EARS	PASSIVE	94V-2
NO	NO E.D.P.	5559-12P5	12	W/O EAR	PASSIVE	94V-2
NO	NO E.D.P.	5559-12P4-2 I0	12	W/EARS	PASSIVE	94V-0
NO	NO E.D.P.	5559-12P5-2 I0	12	W/O EAR	PASSIVE	94V-0

THIS DRAWING REPLACES DRAWING SD-5559-NLP+

THIS DRAWING CONTAINS INFORMATION THAT IS PROPRIETARY TO MOLEX ELECTRONIC TECHNOLOGIES, LLC AND SHOULD NOT BE USED WITHOUT WRITTEN PERMISSION											
DIMENSION UNITS IN/MM		SCALE 1:1		CURRENT REV DESC: REMOVED OBSOLETE PART NUMBER AS PER PCN#511918							
GENERAL TOLERANCES (UNLESS SPECIFIED)						EC NO: 703993					
		MM		INCH		DRWN: SUGEEB		2022/04/25		MINI-FIT JR. SERIES PLUG (SINGLE ROW)	
4 PLACES		±		±		CHK'D: GGA		2022/04/25			
3 PLACES		±		± 0.01		APPR: GGA		2022/04/25		PRODUCT CUSTOMER DRAWING	
2 PLACES		± 0.25		± 0.015		INITIAL REVISION:		DOCUMENT NUMBER			
1 PLACE		± 0.38		±		DRWN: KSS		1989/02/19		55590002-SD	
0 PLACES		±		±		APPR: FSMITH		2011/03/10		PSD 000 A1	
ANGULAR TOL ± 0.5 °						THIRD ANGLE PROJECTION		DRAWING		SERIES	
DRAFT WHERE APPLICABLE MUST REMAIN WITHIN DIMENSIONS								C-SIZE		5559	
		MATERIAL NUMBER		CUSTOMER		SHEET NUMBER		SEE TABLE		GENERAL MARKET 3 OF 3	

LEGEND

