



产品编号 : [39014033](#)

Product Description : Mini-Fit Jr. Plug Housing, Single Row, 3 Circuits, UL 94V-0, with Panel Mounting Ears, Natural

系列号 : 5559

状态 : Active

Product Category : Connector Housings

工程编号 : 5559-03P2-210

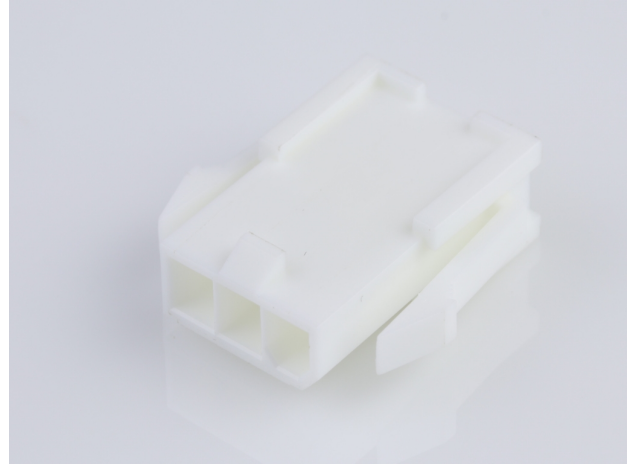

## 文件和资源

### 图纸

[图纸 039014033\\_sd.pdf](#)

### 3D 模型和设计文件

[3D模型 039014033\\_stp.zip](#)

### 规格

[应用规格 55560001-AS-000.pdf](#)

[应用规格 AS-5557-001-001.pdf](#)

[包装规格 PK-5559-003-001.pdf](#)

[产品规格 PS-45750-001-001.pdf](#)

[产品规格 PS-5556-001-001.pdf](#)

[测试摘要 55560010-TS-000.pdf](#)

[测试摘要 TS-5556-002-001.pdf](#)

## 产物环境合规

### 合规

GADSL/IMDS	Not Relevant
China RoHS	
EU ELV	Compliant per 2000/53/EC
Low-Halogen Status	Low-Halogen per IEC 61249-2-21
REACH SVHC	Not Contained per D(2023)3788-DC (14 Jun 2023)
EU RoHS	Compliant per EU 2015/863

PART NO.	ENG. NO.	CKT. NO.	MOUNT OPTION	MAT'L.	RAMP OPTION
39-01-4032	5559-03P2	3	2	BLANK	POSITIVE
39-01-4033	5559-03P2-210	3	2	210	POSITIVE
<b>46999-0291</b>	<b>5559-03P2-400</b>	3	2	<b>400</b>	POSITIVE
39-01-4036	5559-03P3	3	3	BLANK	POSITIVE
39-01-4037	5559-03P3-210	3	3	210	POSITIVE
<b>46999-0290</b>	<b>5559-03P3-400</b>	3	3	<b>400</b>	POSITIVE
39-01-6030	5559-03P2-BL	3	2	BL	POSITIVE
39-01-6031	5559-03P3-BL	3	3	BL	POSITIVE
50-29-0088	5559-03P4	3	4	BLANK	PASSIVE
50-29-0089	5559-03P5	3	5	BLANK	PASSIVE
50-29-0091	5559-03P4-210	3	4	210	PASSIVE
50-29-0093	5559-03P4-BL	3	4	BL	PASSIVE
50-29-0094	5559-03P5-BL	3	5	BL	PASSIVE

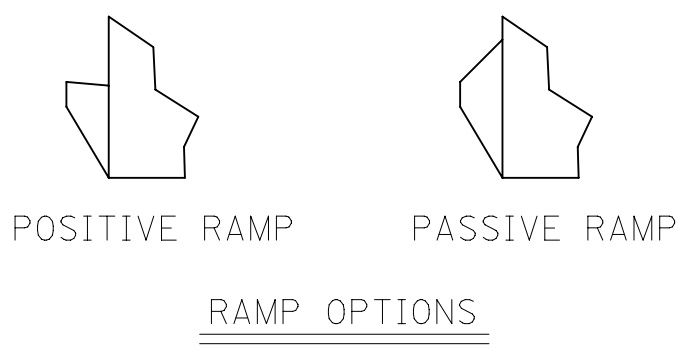
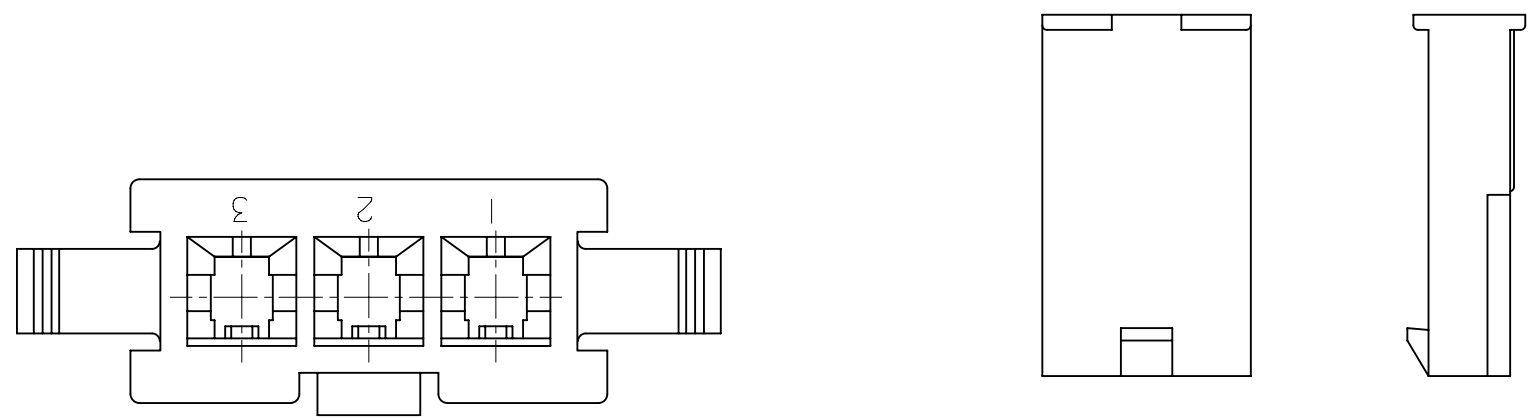

5559-03P3-\*\*\*  
WITHOUT MOUNTING EARS

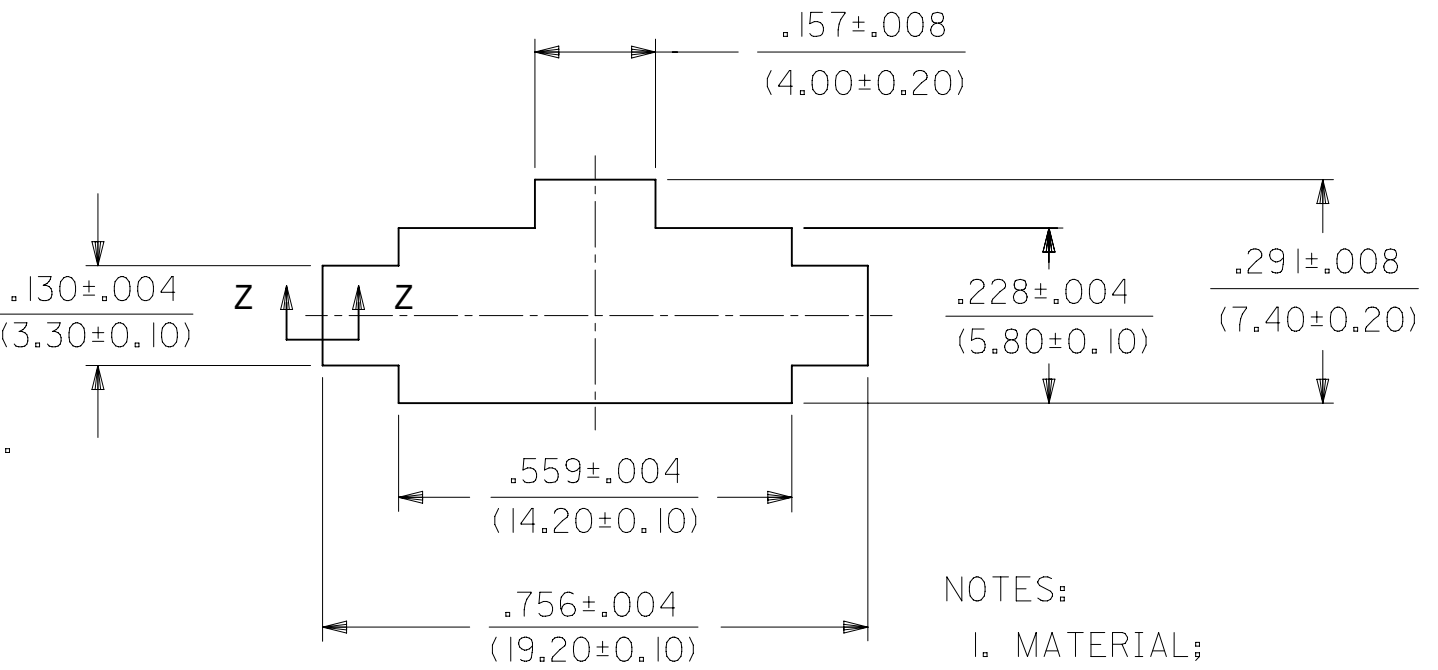
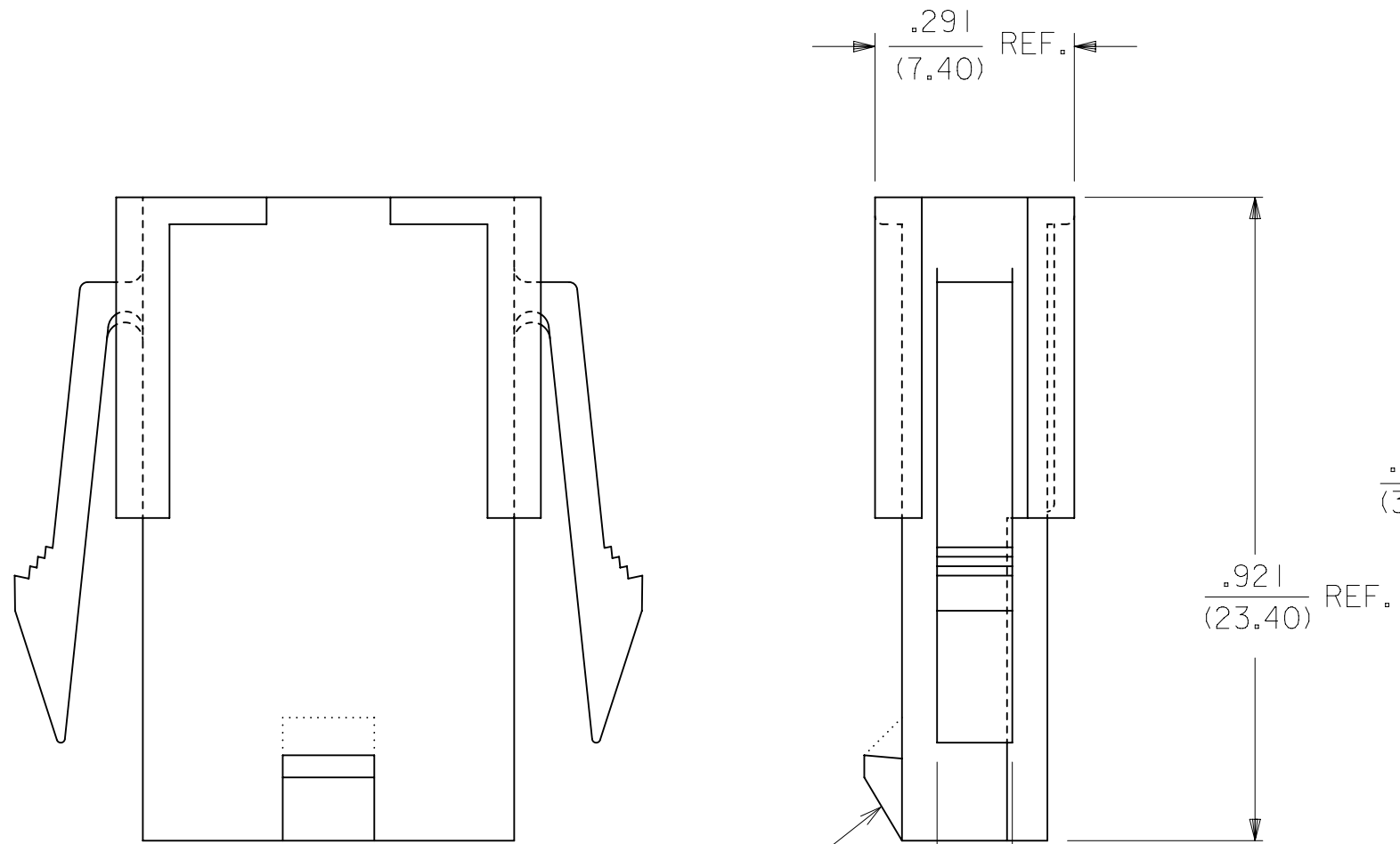

- NOTES:
- MATERIAL;  
BLANK=NYLON 6/6, UL 94V-2, COLOR: NATURAL.  
210=NYLON 6/6, UL 94V-0, COLOR: NATURAL.  
BL=NYLON 6/6, UL 94V-2, COLOR: BLACK.  
400=NYLON 6/6, UL 94V-0, COLOR: BLACK
  - FINISH: NOT APPLICABLE
  - PRODUCT SPECIFICATION: PS-5556-001
  - PACKAGING SPECIFICATION: PK-5559-003
  - THIS PART MATES WITH RECEPTACLE NO 5557.
  - THIS PART IS FOR USE WITH MOLEX MALE TERMINAL NO. 5558-\*. THICK PANELS.
  - PANEL MOUNT VERSION IS FOR USE WITH .031/.079/(0.80/2.00)
  - PANEL SHOULD BE PUNCHED IN THE DIRECTION OF CONNECTOR INSERTION.
  - MOUNTING & RAMP OPTION:  
2 = WITH EARS, WITH POSITIVE RAMP  
3 = WITHOUT EARS, WITH POSITIVE RAMP  
4 = WITH EARS, WITH PASSIVE RAMP  
5 = WITHOUT EARS, WITH PASSIVE RAMP
  - PART IS NOT DESIGNED FOR CURRENT SHARING.
  - CONNECTORS ARE NOT TO BE MATED OR UNMATED WHILE CIRCUITS ARE LIVE.
  - WIRES ARE TO BE DRESSED IN SUCH A MANNER TO ALLOW THE TERMINALS TO FLOAT FREELY IN THE POCKET.
  - PART CONFORMS TO CLASS "B" REQUIREMENTS OF COSMETIC SPECIFICATION PS-45499-002.

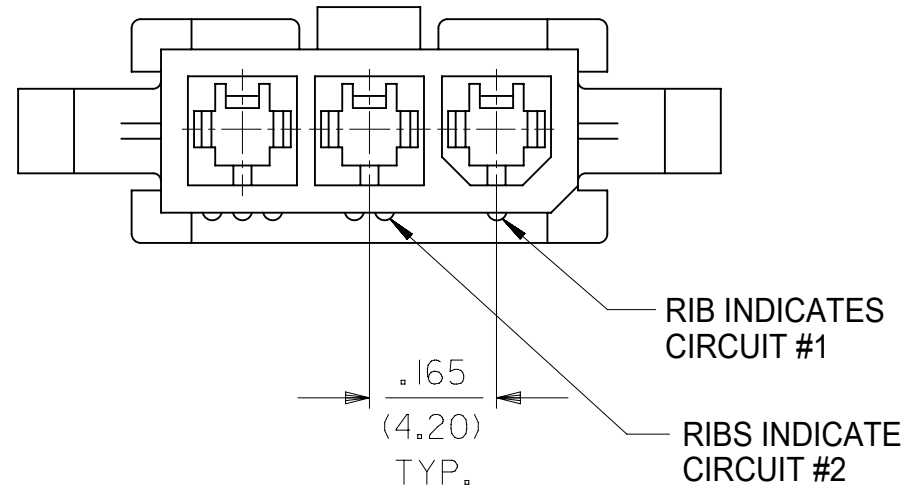
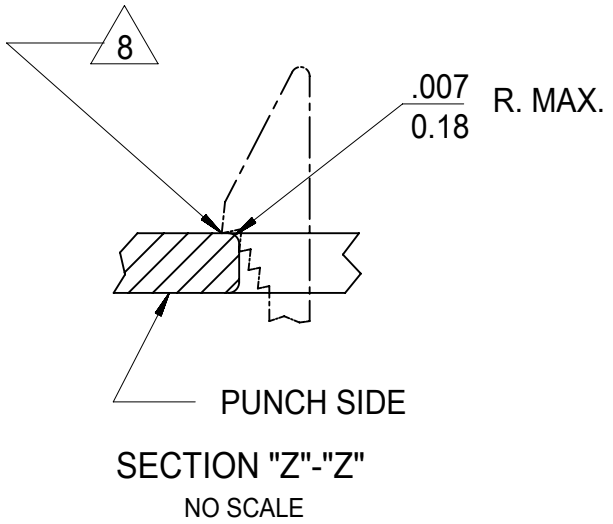

LEGEND

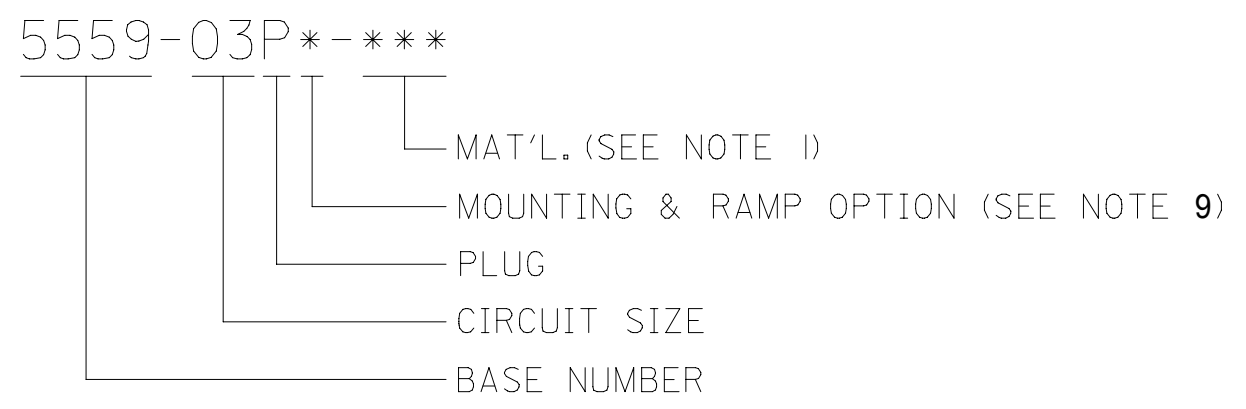

SYMBOLS		THIS DRAWING CONTAINS INFORMATION THAT IS PROPRIETARY TO MOLEX ELECTRONIC TECHNOLOGIES, LLC AND SHOULD NOT BE USED WITHOUT WRITTEN PERMISSION	
∇ = 0	IN/MM	SCALE	4:1
∇ = 0	GENERAL TOLERANCES (UNLESS SPECIFIED)		
∇ = 0		MM	INCH
S = 0	4 PLACES	±	±
∇ = 0	3 PLACES	±	± 0.01
∇ = 0	2 PLACES	± 0.25	± 0.015
∇ = 0	1 PLACE	± 0.38	±
∇ = 0	0 PLACES	±	±
∇ = 0	ANGULAR TOL	± 0.5 °	
∇ = 0	DRAFT WHERE APPLICABLE MUST REMAIN WITHIN DIMENSIONS		
∇ = 0	THIRD ANGLE PROJECTION	DRAWING	C-SIZE
CURRENT REV DESC: MIGRATE TO ECTR		SERIES	5559
EC NO: 172489		DRWN: AZAHIROVIC	2018/01/12
DRWN: AZAHIROVIC		CHK'D: JBELL	2018/02/20
APPR: FSMITH		2018/02/22	
INITIAL REVISION:		DRWN: GEP	1990/07/11
		APPR: RAS	1990/07/11
DOCUMENT NUMBER		MATERIAL NUMBER	CUSTOMER
55590300-SD		SEE CHART	GENERAL MARKET
DOC TYPE		DOC PART	REVISION
PSD		000	A
SHEET NUMBER		1 OF 1	

## 多部分产品合规性声明

- Eu RoHS
- REACH SVHC
- Low-Halogen

## 多部分行业合规性文件

- IPC 1752A Class C
- IPC 1752A Class D
- Molex Product Compliance Declaration
- IEC-62474
- chemSHERPA (xml)

## 欧盟 RoHS 合格证书

---

## 产品详情

### 常规

状态	活动
类别	Connector Housings
系列	5559
说明	Mini-Fit Jr. Plug Housing, Single Row, 3 Circuits, UL 94V-0, with Panel Mounting Ears, Natural
应用	Power, Wire-to-Board, Wire-to-Wire
个评论	Current = 13A max. per circuit when header is mated to a receptacle loaded with 45750 series terminals crimped to 16 AWG wire. See Molex product specification PS-45750-001 for additional current derating information.
产品系列	Mini-Fit Family Power Connectors
产品名称	Mini-Fit Jr.
UPC	800754381062

### 机构

CSA	LR19980
UL	E29179

### 物理

断开	否
----	---

电路数 (最多)	3
颜色-树脂	Natural
阻燃性	94V-0
性别	Plug
符合灼热丝规范	否
插接极性	无
锁定插接部位	是
材料 - 树脂	Nylon
净重	1.439/g
行数	1
包装形式	Bag
面板安装式	是
间距 - 插配接口	4.20mm
间距 - 终端界面	4.20mm
有极性的插配件	是
可堆叠的	否
运行温度范围	-40° to +105° C

## 进程

无铅	不适用
----	-----

## 可配插/可连接使用的产品

### 可配插部件

描述	产品编号
Mini-Fit Jr. Receptacle Housing, Single Row, 3 Circuits, UL 94V-0, Natural	<u>0039014031</u>
Mini-Fit TPA2-to-Mini-Fit TPA2 Off-the-Shelf (OTS) Cable Assemblies	<u>145135</u>

### 可连接使用部件

描述	产品编号
Pre-Crimped Lead Mini-Fit Male-to-Mini-Fit Male, Tin (Sn) Plating, 150.00mm Length, 18 AWG, Red	<u><a href="/content/molex/molex-dot-com/cn/zh/products/product-page.html/797580005.html">/content/molex/molex-dot-com/cn/zh/products/product-page.html/797580005.html</a></u>

Pre-Crimped Lead Mini-Fit Male-to-Mini-Fit Male, Tin (Sn) Plating, 300.00mm Length, 18 AWG, Red	<a href="/content/molex/molex-dot-com/cn/zh/products/product-page.html/797580013.html">/content/molex/molex-dot-com/cn/zh/products/product-page.html/797580013.html</a>
Mini-Fit Male Crimp Terminals	<u>5558</u>
Mini-Fit Plus Male Crimp Terminals	<u>46012</u>
Mini-Fit Jr. Crimp Grounding Terminals	<u>30490</u>

---

This document was generated on Feb 27, 2024