



产品编号：[430450201](#)

Product Description：Micro-Fit 3.0 Right-Angle Header, 3.00mm Pitch, Dual Row, 2 Circuits, with Snap-in Plastic Peg PCB Lock, Gold, Glow-Wire Capable, Black

系列号：43045

状态：Active

Product Category：PCB Headers and Receptacles

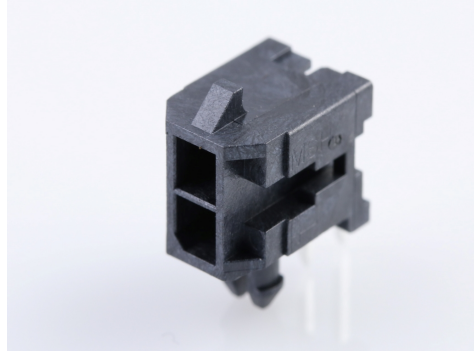

文件和资源

图纸

[图纸 430450201_sd.pdf](#)

[包装设计图 PK-70873-0313-001.pdf](#)

3D 模型和设计文件

[3D模型 430450201_stp.zip](#)

[符号足迹数据 SYM-43045-0200-001.zip](#)

规格

[应用规格 AS-43045-001-001.pdf](#)

[产品规格 430450001-PS-K0-000.pdf](#)

[产品规格 430450001-PS-SP-000.pdf](#)

[产品规格 PS-43045-001.pdf](#)

[测试摘要 430450005-TS-000.pdf](#)

[测试摘要 430450006-TS-000.pdf](#)

[测试摘要 TS-43045-001-001.pdf](#)

[测试摘要 TS-43045-002-001.pdf](#)

[测试摘要 TS-46235-001-001.pdf](#)

产物环境合规

合规

GADSL/IMDS	Not Relevant
China RoHS	
EU ELV	Not Relevant
Low-Halogen Status	Low-Halogen per IEC 61249-2-21
REACH SVHC	Not Contained per D(2023)8585-DC (23 Jan 2024)
EU RoHS	Compliant per EU 2015/863

多部分产品合规性声明

- Eu RoHS
- REACH SVHC
- Low-Halogen

多部分行业合规性文件

- IPC 1752A Class C
- IPC 1752A Class D
- Molex Product Compliance Declaration
- IEC-62474
- chemSHERPA (xml)

欧盟 RoHS 合格证书

产品详情

常规

状态	活动
类别	PCB Headers and Receptacles
系列	43045
说明	Micro-Fit 3.0 Right-Angle Header, 3.00mm Pitch, Dual Row, 2 Circuits, with Snap-in Plastic Peg PCB Lock, Gold, Glow-Wire Capable, Black
应用	Power, Wire-to-Board

个评论	High Temperature, Square Pin, Solder Type; This Molex product is manufactured from material that has the following ratings, tested by independent agencies: a) A Glow Wire Ignition Temperature (GWIT) of at least 775 deg C per IEC 60695-2-13. b) A Glow Wire Flammability Index (GWFI) above 850 deg C per IEC 60695-2-12 and hence complies with the requirements set out in the International Standard IEC 60335-1 5th edition - household and similar electrical appliances - safety, section 30 Resistance to heat and fire. The customers using this product must determine its suitability for use in their particular application through testing or other acceptable means as described in end-product glow-wire flammability test standard IEC 60695-2-11 and any applicable product end-use standard(s). If it is determined during the customer's evaluation of suitability, that higher performance is required, please contact Molex for possible product options.
元件类型	PCB Header
产品系列	Micro-Fit Connector System
产品名称	Micro-Fit 3.0
UPC	800754369732

机构

CSA	LR19980
UL	E29179

电气

每触点最大电流	8.5A
电压 - 最大	600V

物理

断开	否
回路数 (已载入)	2
电路数 (最多)	2

颜色-树脂	黑色
耐用性(插拔次数) - 最多次数	30
阻燃性	94V-0
符合灼热丝规范	是
插配长度	10.29mm
材料 - 金属	Brass
材料 - 接合部位电镀	金牌
材料 - 终端电镀	Tin
材料 - 树脂	High Temperature Thermoplastic
净重	0.540/g
行数	2
方向	Right Angle
包装形式	Tray
PCB 定位器	是
PCB 保持力	是
推荐的 PCB 厚度	1.60mm
间距 - 插配接口	3.00mm
最薄镀层 - 接合部位	0.381µm
PCB 极性	是
有护墙的	Fully
可堆叠的	否
运行温度范围	-40° to +125° C
终端界面类型	Through Hole

进程

最长持续时间	30
无铅	SMC&WAVE
最大周期	3
最高温度	260

可配插/可连接使用的产品

可配插部件

描述	产品编号
----	------

Micro-Fit 3.0 Dual Row Receptacle Housings	<u>43025</u>
Micro-Fit TPA Receptacle Housings	<u>172952</u>
Micro-Fit 3.0 Female-to-Micro-Fit 3.0 Female Off-the-Shelf (OTS) Cable Assemblies	<u>214755</u>
Micro-Fit 3.0 Female-to-Pigtail Off-the-Shelf (OTS) Cable Assemblies	<u>214756</u>

This document was generated on Mar 25, 2024

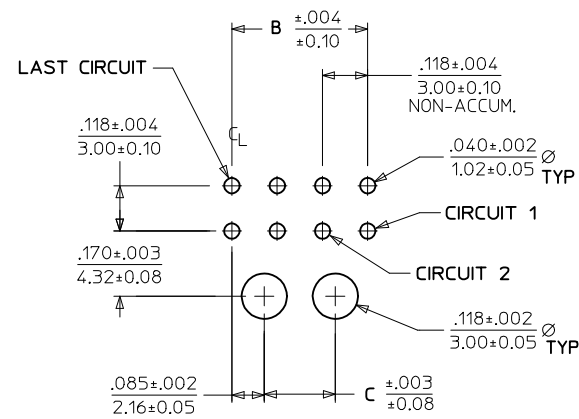
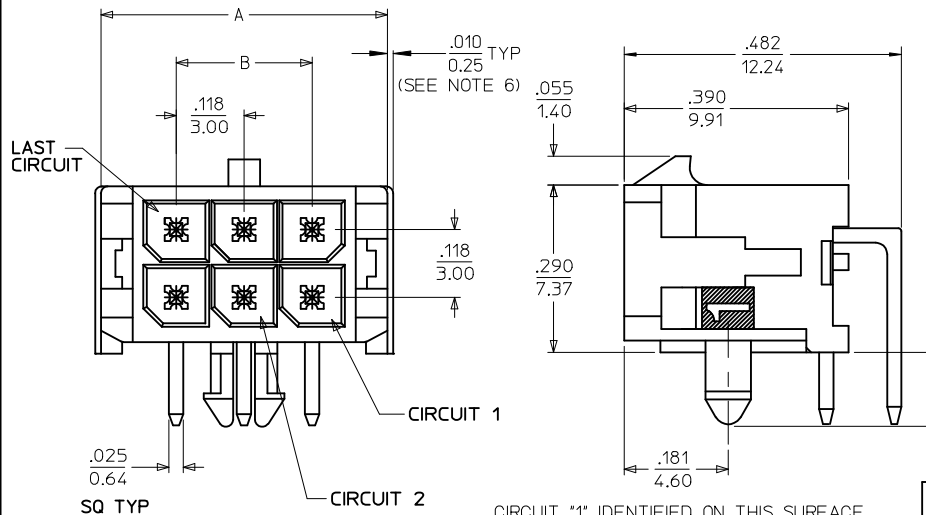
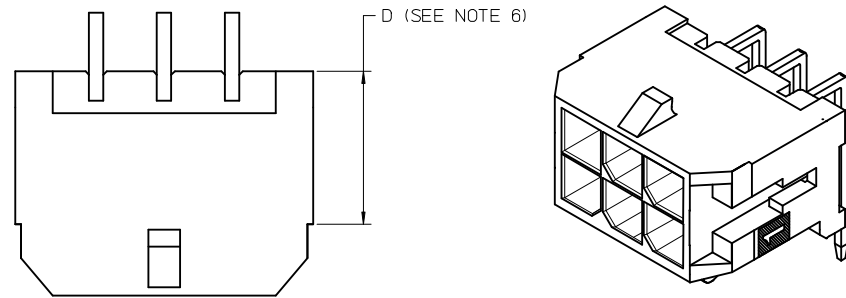

PCB LAYOUT: COMPONENT SIDE
RECOMMEND PCB THICKNESS: .062/1.57

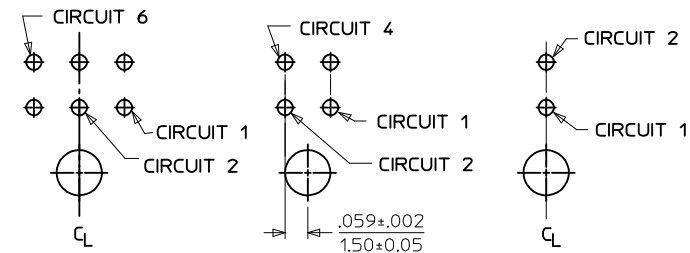

PCB LAYOUT:
6 CKT HEADER PCB LAYOUT:
4 CKT HEADER PCB LAYOUT:
2 CKT HEADER

CKTS	A	B	C
02	.262 6.65	NA	NA
04	.380 9.65	.118 3.00	NA
06	.498 12.65	.236 6.00	NA
08	.616 15.65	.354 9.00	.185 4.70
10	.734 18.65	.472 12.00	.303 7.70
12	.852 21.65	.591 15.00	.421 10.70
14	.970 24.65	.709 18.00	.539 13.70
16	1.088 27.65	.827 21.00	.657 16.70
18	1.206 30.65	.945 24.00	.776 19.70
20	1.325 33.65	1.063 27.00	.894 22.70
22	1.443 36.65	1.181 30.00	1.012 25.70
24	1.561 39.65	1.299 33.00	1.130 28.70

NOTES:

- HOUSING MATERIAL: GLASS FILLED LIQUID CRYSTAL POLYMER, UL94V-0. COLOR: BLACK
TERMINAL MATERIAL: BRASS ALLOY
- FINISH: A = .000060/(0.00152) MIN. REFLOWED MATTE TIN OVER
.000050/(0.00127) MIN. NICKEL PLATE.
(FINISH IS BRIGHT IN APPEARANCE. THICKNESS AS APPLIED
PRIOR TO REFLOW)
B = .00015/(0.00038) MIN. SELECT GOLD IN CONTACT AREA;
.000100/(0.00254) MIN. SELECT MATTE TIN ON SOLDER TAILS,
BOTH OVER .000050/(0.00127) MIN. NICKEL PLATE.
C = .000030/(0.00076) MIN. SELECT GOLD IN CONTACT AREA;
.000100/(0.00254) MIN. SELECT MATTE TIN ON SOLDER TAILS;
BOTH OVER .000050/(0.00127) MIN. NICKEL PLATE.
D = .000100/(0.00254) MIN. MATTE TIN OVER
.000050/(0.00127) MIN. NICKEL OVERALL
- PRODUCT SPECIFICATION: PS-43045
- TRAY PACKAGED : SEE MOLEX DRAWING PK-70873-0313
- MATES WITH MICRO FIT (3.0) RECEPTACLE SERIES 43025
- CIRCUIT SIZES 2-6: 'D' IS .265/6.74 FOR .010/0.25 STEP.
CIRCUIT SIZES 8-24: 'D' IS .063/1.60 FOR .010/0.25 STEP.
- TO AVOID INTERFERENCE BETWEEN RECEPTACLE AND PCB, HEADER MUST BE PLACED
WITHIN .400/(10.16) MAX. FROM EDGE OF PCB, AS SHOWN IN LOCATION DETAIL.
- THIS PART CONFORMS TO CLASS B REQUIREMENTS OF PRODUCT SPECIFICATION
PS-45499-002.

CIRCUIT "1" IDENTIFIED ON THIS SURFACE
(APPROX. LOCATION SHOWN FOR REF.)

	FINISH A	FINISH B	FINISH C	FINISH D
CKTS	MATERIAL NO:	MATERIAL NO:	MATERIAL NO:	MATERIAL NO:
02	43045-0200	43045-0201	43045-0202	43045-0310
04	43045-0400	43045-0401	43045-0402	43045-0510
06	43045-0600	43045-0601	43045-0602	43045-0710
08	43045-0800	43045-0801	43045-0802	43045-0910
10	43045-1000	43045-1001	43045-1002	43045-1110
12	43045-1200	43045-1201	43045-1202	43045-1310
14	43045-1400	43045-1401	43045-1402	43045-1510
16	43045-1600	43045-1601	43045-1602	43045-1710
18	43045-1800	43045-1801	43045-1802	43045-1910
20	43045-2000	43045-2001	43045-2002	43045-2110
22	43045-2200	43045-2201	43045-2202	43045-2310
24	43045-2400	43045-2401	43045-2402	43045-2510

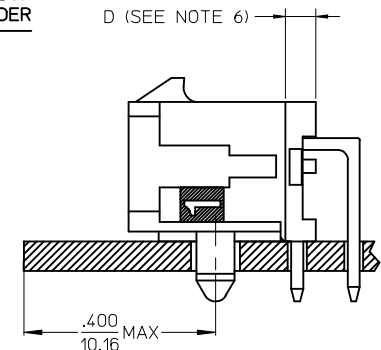

LOCATION DETAIL
SEE NOTE #7

FINISH A & D EC NO: UCP2016-4586 DRWIN:JDOX 2015/12/10 CHKD:SSONSEK 2015/12/10 APPR:FSMITH 2016/08/23 (REV)	QUALITY SYMBOLS ▽=0 ▽=0 ▽=0	GENERAL TOLERANCES (UNLESS SPECIFIED) <table border="1"> <tr><th>mm</th><th>INCH</th></tr> <tr><td>4 PLACES ± ---</td><td>± ---</td></tr> <tr><td>3 PLACES ± ---</td><td>± .010</td></tr> <tr><td>2 PLACES ± 0.25</td><td>± .014</td></tr> <tr><td>1 PLACE ± 0.36</td><td>± ---</td></tr> <tr><td>0 PLACE ± ---</td><td>± ---</td></tr> </table>	mm	INCH	4 PLACES ± ---	± ---	3 PLACES ± ---	± .010	2 PLACES ± 0.25	± .014	1 PLACE ± 0.36	± ---	0 PLACE ± ---	± ---	DIMENSION STYLE IN/MM DRAWN BY DATE SAMIEC 2000/03/15 CHECKED BY DATE MUELLER 2000/03/15 APPROVED BY DATE FSMITH 2016/08/23	SCALE --- DESIGN UNITS METRIC THIRD ANGLE PROJECTION	MICRO-FIT (3.0) DUAL ROW RIGHT ANGLE THRU HOLE HEADER ASS'Y molex
	mm	INCH															
	4 PLACES ± ---	± ---															
3 PLACES ± ---	± .010																
2 PLACES ± 0.25	± .014																
1 PLACE ± 0.36	± ---																
0 PLACE ± ---	± ---																
DRAFT WHERE APPLICABLE MUST REMAIN WITHIN DIMENSIONS		MATERIAL NO. SEE CHART	DOCUMENT NO. SD-43045-001	SHEET NO. 1 OF 1													
THIS DRAWING CONTAINS INFORMATION THAT IS PROPRIETARY TO MOLEX INCORPORATED AND SHOULD NOT BE USED WITHOUT WRITTEN PERMISSION																	

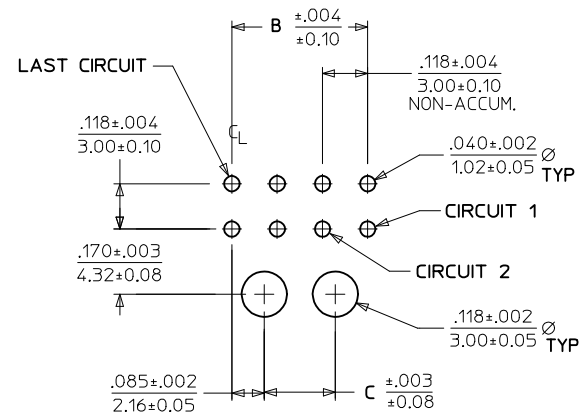
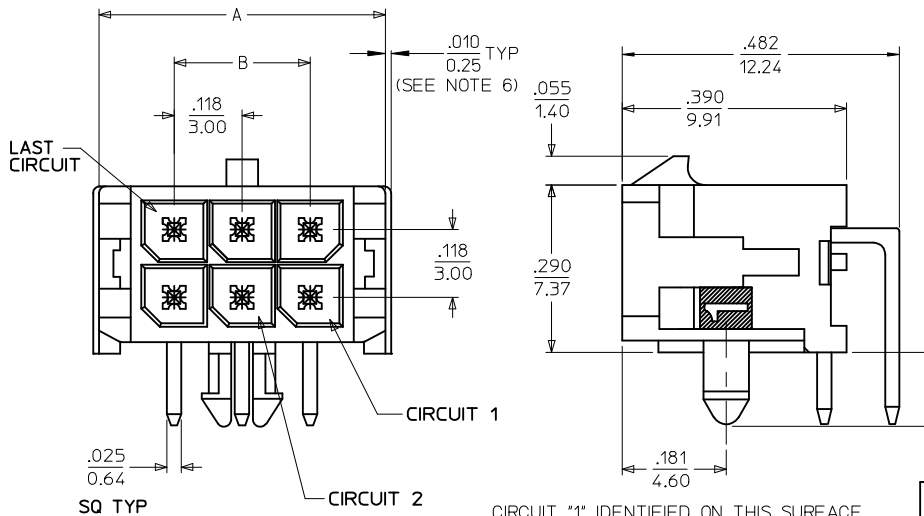
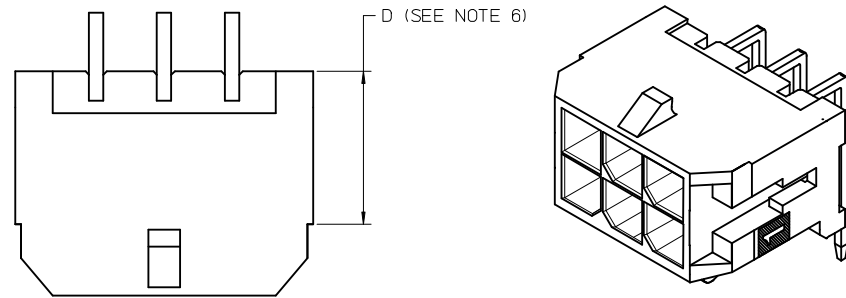

PCB LAYOUT: COMPONENT SIDE
RECOMMEND PCB THICKNESS: .062/1.57

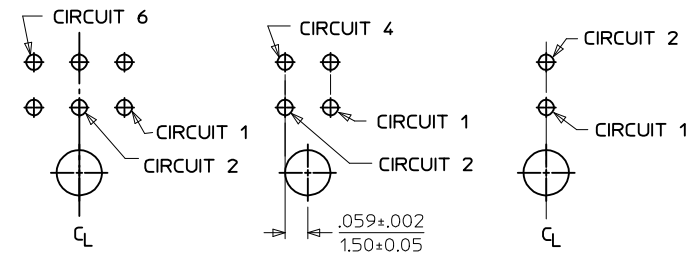

PCB LAYOUT: 6 CKT HEADER PCB LAYOUT: 4 CKT HEADER PCB LAYOUT: 2 CKT HEADER

CKTS	A	B	C
02	.262 6.65	NA	NA
04	.380 9.65	.118 3.00	NA
06	.498 12.65	.236 6.00	NA
08	.616 15.65	.354 9.00	.185 4.70
10	.734 18.65	.472 12.00	.303 7.70
12	.852 21.65	.591 15.00	.421 10.70
14	.970 24.65	.709 18.00	.539 13.70
16	1.088 27.65	.827 21.00	.657 16.70
18	1.206 30.65	.945 24.00	.776 19.70
20	1.325 33.65	1.063 27.00	.894 22.70
22	1.443 36.65	1.181 30.00	1.012 25.70
24	1.561 39.65	1.299 33.00	1.130 28.70

NOTES:

- HOUSING MATERIAL: GLASS FILLED LIQUID CRYSTAL POLYMER, UL94V-0. COLOR: BLACK
TERMINAL MATERIAL: BRASS ALLOY
- FINISH: A = .000060/(0.00152) MIN. REFLOWED MATTE TIN OVER
.000050/(0.00127) MIN. NICKEL PLATE.
(FINISH IS BRIGHT IN APPEARANCE. THICKNESS AS APPLIED PRIOR TO REFLOW)
B = .00015/(0.00038) MIN. SELECT GOLD IN CONTACT AREA;
.000100/(0.00254) MIN. SELECT MATTE TIN ON SOLDER TAILS,
BOTH OVER .000050/(0.00127) MIN. NICKEL PLATE.
C = .000030/(0.00076) MIN. SELECT GOLD IN CONTACT AREA;
.000100/(0.00254) MIN. SELECT MATTE TIN ON SOLDER TAILS;
BOTH OVER .000050/(0.00127) MIN. NICKEL PLATE.
D = .000100/(0.00254) MIN. MATTE TIN OVER
.000050/(0.00127) MIN. NICKEL OVERALL
- PRODUCT SPECIFICATION: PS-43045
- TRAY PACKAGED : SEE MOLEX DRAWING PK-70873-0313
- MATES WITH MICRO FIT (3.0) RECEPTACLE SERIES 43025
- CIRCUIT SIZES 2-6: 'D' IS .265/6.74 FOR .010/0.25 STEP.
CIRCUIT SIZES 8-24: 'D' IS .063/1.60 FOR .010/0.25 STEP.
- TO AVOID INTERFERENCE BETWEEN RECEPTACLE AND PCB, HEADER MUST BE PLACED WITHIN .400/(10.16) MAX. FROM EDGE OF PCB, AS SHOWN IN LOCATION DETAIL.
- THIS PART CONFORMS TO CLASS B REQUIREMENTS OF PRODUCT SPECIFICATION PS-45499-002.

CIRCUIT "1" IDENTIFIED ON THIS SURFACE
(APPROX. LOCATION SHOWN FOR REF.)

CKTS	FINISH A MATERIAL NO:	FINISH B MATERIAL NO:	FINISH C MATERIAL NO:	FINISH D MATERIAL NO:
02	43045-0200	43045-0201	43045-0202	43045-0310
04	43045-0400	43045-0401	43045-0402	43045-0510
06	43045-0600	43045-0601	43045-0602	43045-0710
08	43045-0800	43045-0801	43045-0802	43045-0910
10	43045-1000	43045-1001	43045-1002	43045-1110
12	43045-1200	43045-1201	43045-1202	43045-1310
14	43045-1400	43045-1401	43045-1402	43045-1510
16	43045-1600	43045-1601	43045-1602	43045-1710
18	43045-1800	43045-1801	43045-1802	43045-1910
20	43045-2000	43045-2001	43045-2002	43045-2110
22	43045-2200	43045-2201	43045-2202	43045-2310
24	43045-2400	43045-2401	43045-2402	43045-2510

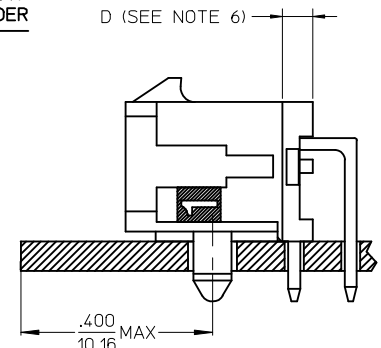

LOCATION DETAIL
SEE NOTE #7

FINISH A & D EC NO: UCP2016-4586 DRWIN:JDOX 2015/12/10 CHKD:SSONSEK 2015/12/10 APPR:FSMITH 2016/08/23 (REV)	QUALITY SYMBOLS ▽=0 ▽=0 ▽=0	GENERAL TOLERANCES (UNLESS SPECIFIED) <table border="1"> <tr> <th></th> <th>mm</th> <th>INCH</th> </tr> <tr> <td>4 PLACES</td> <td>± .005</td> <td>± .001</td> </tr> <tr> <td>3 PLACES</td> <td>± .005</td> <td>± .010</td> </tr> <tr> <td>2 PLACES</td> <td>± 0.25</td> <td>± .014</td> </tr> <tr> <td>1 PLACE</td> <td>± 0.36</td> <td>± .014</td> </tr> <tr> <td>0 PLACE</td> <td>± .005</td> <td>± .005</td> </tr> </table>		mm	INCH	4 PLACES	± .005	± .001	3 PLACES	± .005	± .010	2 PLACES	± 0.25	± .014	1 PLACE	± 0.36	± .014	0 PLACE	± .005	± .005	DIMENSION STYLE IN/MM DRAWN BY: SAMIEC DATE: 2000/03/15 CHECKED BY: MUELLER DATE: 2000/03/15 APPROVED BY: FSMITH DATE: 2016/08/23	SCALE: --- DESIGN UNITS: METRIC THIRD ANGLE PROJECTION
		mm	INCH																			
	4 PLACES	± .005	± .001																			
3 PLACES	± .005	± .010																				
2 PLACES	± 0.25	± .014																				
1 PLACE	± 0.36	± .014																				
0 PLACE	± .005	± .005																				
DRAFT WHERE APPLICABLE MUST REMAIN WITHIN DIMENSIONS		MATERIAL NO. SEE CHART	DOCUMENT NO. SD-43045-001	SHEET NO. 1 OF 1																		
MICRO-FIT (3.0) DUAL ROW RIGHT ANGLE THRU HOLE HEADER ASS'Y 																						

20 19 18 17 16 15 14 13 12 11 9 8 7 6 5 4 3 2 1

43045

MICRO-FIT(3.0)
DUAL-ROW SERIES

MICRO-FIT(3.0)
IN-LINE SERIES

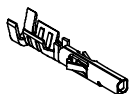

43030-xxxx
FEMALE CRIMP TERMINAL

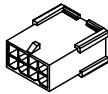

43020-xx01
PLUG W/O MTG. EARS

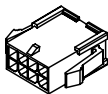

43020-xx00
PLUG W/ MTG. EARS

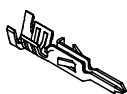

43031-xxxx
MALE CRIMP TERMINAL

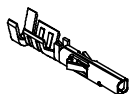

43030-xxxx
FEMALE CRIMP TERMINAL

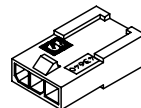

43640-xx01
PLUG W/O MTG. EARS

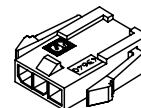

43640-xx00
PLUG W/ MTG. EARS

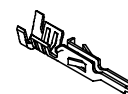

43031-xxxx
MALE CRIMP TERMINAL

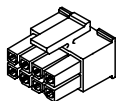

43025-xxxx
RECEPTACLE

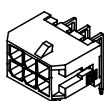

43045-xx00 THRU 43045-xx02
RIGHT ANGLE THRU HOLE
W/RETENTION PEG

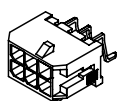

43045-xx03 THRU 43045-xx05
RIGHT ANGLE SURFACE MOUNT
W/RETENTION PEG

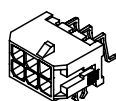

43045-xx06 THRU 43045-xx08
RIGHT ANGLE SURFACE MOUNT
W/RETENTION CLIP

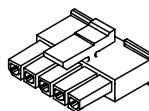

43645-xxxx
RECEPTACLE

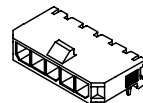

43650-xx00 THRU 43650-xx02
RIGHT ANGLE THRU HOLE
W/RETENTION PEG

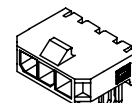

43650-xx03 THRU 43650-xx05
RIGHT ANGLE THRU HOLE
W/RETENTION CLIP

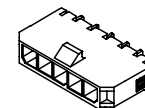

43650-xx06 THRU 43650-xx08
RIGHT ANGLE SURFACE MOUNT
W/RETENTION PEG

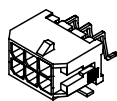

43045-xx09 THRU 43045-xx11
RIGHT ANGLE SURFACE MOUNT
W/FITTING NAIL

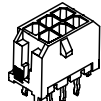

43045-xx12 THRU 43045-xx14
VERTICAL O.T.R. THRU HOLE

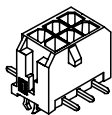

43045-xx15 THRU 43045-xx17
VERTICAL SURFACE MOUNT
W/RETENTION CLIP

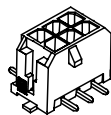

43045-xx18 THRU 43045-xx20
VERTICAL SURFACE MOUNT
W/FITTING NAIL

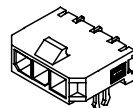

43650-xx09 THRU 43650-xx11
RIGHT ANGLE SURFACE MOUNT
W/RETENTION CLIP

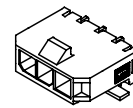

43650-xx12 THRU 43650-xx14
RIGHT ANGLE SURFACE MOUNT
W/FITTING NAIL

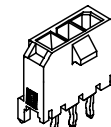

43650-xx15 THRU 43650-xx17
VERTICAL O.T.R. THRU HOLE

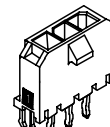

43650-xx18 THRU 43650-xx20
VERTICAL O.T.R. THRU HOLE
W/RETENTION CLIP

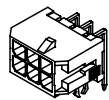

43045-xx21 THRU 43045-xx23
RIGHT ANGLE THRU HOLE
W/RETENTION CLIP

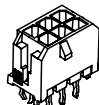

43045-xx24 THRU 43045-xx26
VERTICAL O.T.R. THRU HOLE
W/RETENTION CLIP

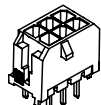

43045-xx27 THRU 43045-xx29
VERTICAL STRAIGHT PIN THRU HOLE

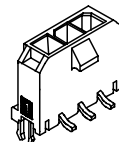

43650-xx21 THRU 43650-xx23
VERTICAL SURFACE MOUNT
W/RETENTION CLIP

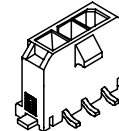

43650-xx24 THRU 43650-xx26
VERTICAL SURFACE MOUNT
W/FITTING NAIL

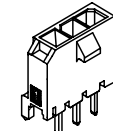

43650-xx27 THRU 43650-xx29
VERTICAL STRAIGHT PIN THRU HOLE

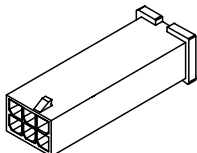

44242-0001 THRU 44242-0011
4-24 CKT. TEST PLUG

REVISED/REDRAWN EC NO. UCP2004-1223 DRWN: ICERNY 2004/03/12 CHKD: CHKDC 2004/03/31 APPR: FSMITH 2004/04/05	QUALITY SYMBOLS	GENERAL TOLERANCES (UNLESS SPECIFIED)		SCALE	DESIGN UNITS	THIRD ANGLE PROJECTION	REVISE ON CAD ONLY			
	▽ 0 ▽ 0	4 PLACES ± 0.15 3 PLACES ± 0.20 2 PLACES ± 0.25 1 PLACE ± 0.30	mm INCH ± 0.15 ± 0.005 ± 0.20 ± 0.008 ± 0.25 ± 0.010 ± 0.30 ± 0.013	DIMENSION STYLE IN/MM	DATE 1999/03/11	DATE 1999/03/11	TITLE MICRO-FIT (3.0) CONNECTOR FAMILY (INDEX DRAWING)			
		ANGULAR ±1/2°		DRAWN BY GUZIK	DATE 1999/03/11	CHECKED BY EDGLEY	DATE 1999/03/11	MATERIAL NO. SEE CHART SDIN-43045-0001	(DOCUMENT NO.) 1 OF 1	SHEET NO. 1 OF 1
		DRAFT WHERE APPLICABLE		MUST REMAIN WITHIN DIMENSIONS		THIS DRAWING CONTAINS INFORMATION THAT IS PROPRIETARY TO MOLEX INCORPORATED AND SHOULD NOT BE USED WITHOUT WRITTEN PERMISSION				

19 18 17 16 15 14 13 12 11 10 9 8 7 6 5 4 3 2 1

20 19 18 17 16 15 14 13 12 11 9 8 7 6 5 4 3 2 1

43045

MICRO-FIT(3.0)
DUAL-ROW SERIES

MICRO-FIT(3.0)
IN-LINE SERIES

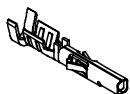

43030-xxxx
FEMALE CRIMP TERMINAL

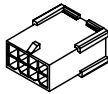

43020-xx01
PLUG W/O MTG. EARS

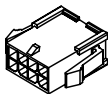

43020-xx00
PLUG W/ MTG. EARS

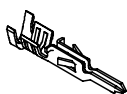

43031-xxxx
MALE CRIMP TERMINAL

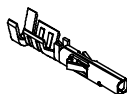

43030-xxxx
FEMALE CRIMP TERMINAL

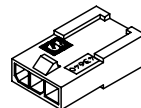

43640-xx01
PLUG W/O MTG. EARS

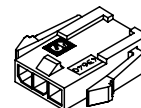

43640-xx00
PLUG W/ MTG. EARS

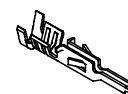

43031-xxxx
MALE CRIMP TERMINAL

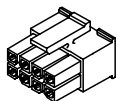

43025-xxxx
RECEPTACLE

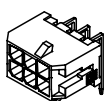

43045-xx00 THRU 43045-xx02
RIGHT ANGLE THRU HOLE
W/RETENTION PEG

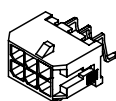

43045-xx03 THRU 43045-xx05
RIGHT ANGLE SURFACE MOUNT
W/RETENTION PEG

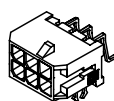

43045-xx06 THRU 43045-xx08
RIGHT ANGLE SURFACE MOUNT
W/RETENTION CLIP

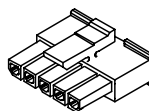

43645-xxxx
RECEPTACLE

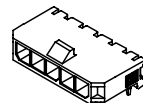

43650-xx00 THRU 43650-xx02
RIGHT ANGLE THRU HOLE
W/RETENTION PEG

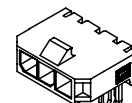

43650-xx03 THRU 43650-xx05
RIGHT ANGLE THRU HOLE
W/RETENTION CLIP

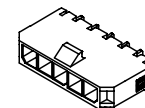

43650-xx06 THRU 43650-xx08
RIGHT ANGLE SURFACE MOUNT
W/RETENTION PEG

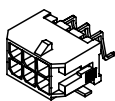

43045-xx09 THRU 43045-xx11
RIGHT ANGLE SURFACE MOUNT
W/FITTING NAIL

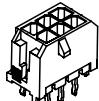

43045-xx12 THRU 43045-xx14
VERTICAL O.T.R. THRU HOLE

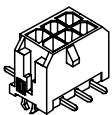

43045-xx15 THRU 43045-xx17
VERTICAL SURFACE MOUNT
W/RETENTION CLIP

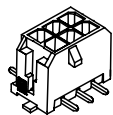

43045-xx18 THRU 43045-xx20
VERTICAL SURFACE MOUNT
W/FITTING NAIL

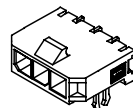

43650-xx09 THRU 43650-xx11
RIGHT ANGLE SURFACE MOUNT
W/RETENTION CLIP

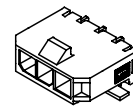

43650-xx12 THRU 43650-xx14
RIGHT ANGLE SURFACE MOUNT
W/FITTING NAIL

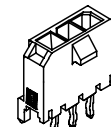

43650-xx15 THRU 43650-xx17
VERTICAL O.T.R. THRU HOLE

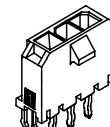

43650-xx18 THRU 43650-xx20
VERTICAL O.T.R. THRU HOLE
W/RETENTION CLIP

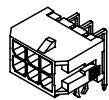

43045-xx21 THRU 43045-xx23
RIGHT ANGLE THRU HOLE
W/RETENTION CLIP

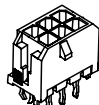

43045-xx24 THRU 43045-xx26
VERTICAL O.T.R. THRU HOLE
W/RETENTION CLIP

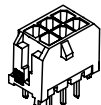

43045-xx27 THRU 43045-xx29
VERTICAL STRAIGHT PIN THRU HOLE

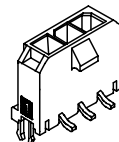

43650-xx21 THRU 43650-xx23
VERTICAL SURFACE MOUNT
W/RETENTION CLIP

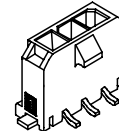

43650-xx24 THRU 43650-xx26
VERTICAL SURFACE MOUNT
W/FITTING NAIL

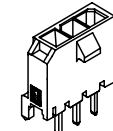

43650-xx27 THRU 43650-xx29
VERTICAL STRAIGHT PIN THRU HOLE

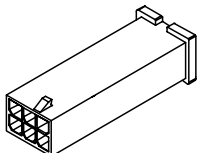

44242-0001 THRU 44242-0011
4-24 CKT. TEST PLUG

REVISED/REDRAWN EC NO. UCP2004-1223 DRWN: ICERNY 2004/03/12 CHKD: CHKDC 2004/03/31 APPR: FSMITH 2004/04/05	QUALITY SYMBOLS	GENERAL TOLERANCES (UNLESS SPECIFIED)		SCALE	DESIGN UNITS	THIRD ANGLE PROJECTION	REVISE ON CAD ONLY	
	▽ 0 ▽ 0	4 PLACES ± 0.10 3 PLACES ± 0.15 2 PLACES ± 0.20 1 PLACE ± 0.30	mm INCH ± 0.10 ± 0.004 ± 0.15 ± 0.005 ± 0.20 ± 0.008 ± 0.30 ± 0.012	DIMENSION STYLE IN/MM	DATE 1999/03/11	DATE 1999/03/11	TITLE MICRO-FIT (3.0) CONNECTOR FAMILY (INDEX DRAWING)	
		DRAFT WHERE APPLICABLE		APPROVED BY	DATE	MATERIAL NO.	DOCUMENT NO.	SHEET NO.
		MUST REMAIN WITHIN DIMENSIONS		EDGLEY	1999/03/11	SEE CHART	SDIN-43045-0001	1 OF 1

19 18 17 16 15 14 13 12 11 10 9 8 7 6 5 4 3 2 1