



产品编号 : [436500515](#)

**Product Description** : Micro-Fit 3.0 Vertical Header, 3.00mm Pitch, Single Row, 5 Circuits, with PCB Polarizing Peg, Tin, Glow-Wire Capable, Black

系列号 : 43650

状态 : Active

**Product Category** : PCB Headers and Receptacles



## 文件和资源

### 图纸

[图纸 436500515\\_sd.pdf](#)

[包装设计图 PK-70873-0811-001.pdf](#)

### 3D 模型和设计文件

[3D模型 436500515\\_stp.zip](#)

[符号足迹数据 SYM-43650-0515-001.zip](#)

### 规格

[产品规格 436500001-PS-JA-000.pdf](#)

[产品规格 436500001-PS-K0-000.pdf](#)

[产品规格 436500001-PS-SP-000.pdf](#)

[产品规格 PS-43650-001.pdf](#)

[测试摘要 430450004-TS-000.pdf](#)

[测试摘要 TS-43045-001-001.pdf](#)

[测试摘要 TS-43045-002-001.pdf](#)

[测试摘要 TS-46235-001-001.pdf](#)

## 产物环境合规

### 合规

GADSL/IMDS	Compliant with Exemption 44; 33
China RoHS	
EU ELV	Not Relevant
Low-Halogen Status	Low-Halogen per IEC 61249-2-21
REACH SVHC	Not Contained per D(2023)8585-DC (23 Jan 2024)
EU RoHS	Compliant per EU 2015/863

## 多部分产品合规性声明

- Eu RoHS
- REACH SVHC
- Low-Halogen

## 多部分行业合规性文件

- IPC 1752A Class C
- IPC 1752A Class D
- Molex Product Compliance Declaration
- IEC-62474
- chemSHERPA (xml)

## 欧盟 RoHS 合格证书

---

## 产品详情

### 常规

状态	活动
类别	PCB Headers and Receptacles
系列	43650
说明	Micro-Fit 3.0 Vertical Header, 3.00mm Pitch, Single Row, 5 Circuits, with PCB Polarizing Peg, Tin, Glow-Wire Capable, Black
应用	Power, Wire-to-Board

个评论	<p>High Temperature, Square Pin, Offset Through Hole Mounting, Solder Type; This Molex product is manufactured from material that has the following ratings, tested by independent agencies:</p> <p>a) A Glow Wire Ignition Temperature (GWIT) of at least 775 deg C per IEC 60695-2-13. b) A Glow Wire Flammability Index (GWFI) above 850 deg C per IEC 60695-2-12 and hence complies with the requirements set out in the International Standard IEC 60335-1 5th edition - household and similar electrical appliances - safety, section 30 Resistance to heat and fire. The customers using this product must determine its suitability for use in their particular application through testing or other acceptable means as described in end-product glow-wire flammability test standard IEC 60695-2-11 and any applicable product end-use standard(s). If it is determined during the customer's evaluation of suitability, that higher performance is required, please contact Molex for possible product options.</p>
元件类型	PCB Header
产品系列	Micro-Fit Connector System
产品名称	Micro-Fit 3.0
UPC	800755008401

#### 机构

CSA	LR19980
UL	E29179

#### 电气

每触点最大电流	8.5A
电压 - 最大	600V

#### 物理

断开	否
回路数 (已载入)	5
电路数 (最多)	5

颜色-树脂	黑色
耐用性(插拔次数) - 最多次数	30
阻燃性	94V-0
符合灼热丝规范	是
插配长度	17.27mm
材料 - 金属	Brass
材料 - 接合部位电镀	Tin
材料 - 终端电镀	Tin
材料 - 树脂	High Temperature Thermoplastic
净重	0.870/g
行数	1
方向	垂直
包装形式	Tray
PCB 定位器	是
PCB 保持力	是
推荐的 PCB 厚度	1.60mm
间距 - 插配接口	3.00mm
最薄镀层 - 接合部位	2.540µm
最薄镀层 - 端接	2.540µm
PCB 极性	是
有护墙的	Fully
可堆叠的	否
运行温度范围	-40° to +105° C
终端界面类型	Through Hole - Kinked Pin

## 进程

最长持续时间	30
无铅	SMC&WAVE
最大周期	3
最高温度	260

## 可配插/可连接使用的产品

### 可配插部件

描述	产品编号
----	------

Micro-Fit 3.0 Female-to-Micro-Fit 3.0 Female Off-the-Shelf (OTS) Cable Assembly, Single Row, 150.00mm Length, Tin (Sn) Plating, 5 Circuits, Black	<u>2147501051</u>
Micro-Fit 3.0 Female-to-Micro-Fit 3.0 Female Off-the-Shelf (OTS) Cable Assembly, Single Row, 300.00mm Length, Tin (Sn) Plating, 5 Circuits, Black	<u>2147501052</u>
Micro-Fit 3.0 Female-to-Micro-Fit 3.0 Female Off-the-Shelf (OTS) Cable Assembly, Single Row, 600.00mm Length, Tin (Sn) Plating, 5 Circuits, Black	<u>2147501053</u>
Micro-Fit 3.0 Female-to-Pigtail Off-the-Shelf (OTS) Cable Assembly, Single Row, 150.00mm Length, Tin (Sn) Plating, 5 Circuits, Black	<u>2147511051</u>
Micro-Fit 3.0 Female-to-Pigtail Off-the-Shelf (OTS) Cable Assembly, Single Row, 300.00mm Length, Tin (Sn) Plating, 5 Circuits, Black	<u>2147511052</u>
Micro-Fit 3.0 Female-to-Pigtail Off-the-Shelf (OTS) Cable Assembly, Single Row, 600.00mm Length, Tin (Sn) Plating, 5 Circuits, Black	<u>2147511053</u>
Micro-Fit 3.0 Single Row Receptacle Housings	<u>43645</u>
Micro-Fit TPA Single Row Receptacle Housings	<u>171850</u>
Micro-Fit TPA-to-Micro-Fit TPA Off-the-Shelf (OTS) Cable Assemblies	<u>145132</u>

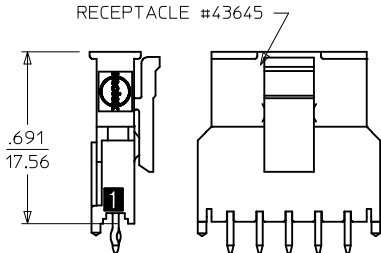
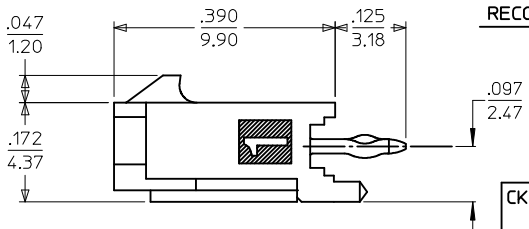
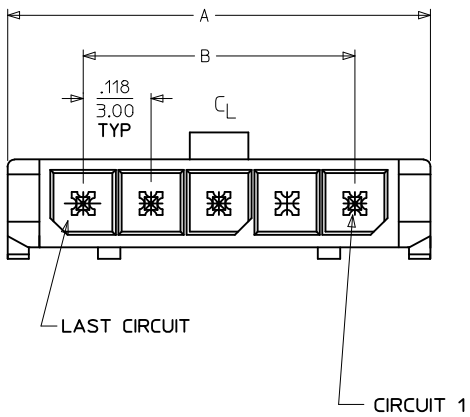
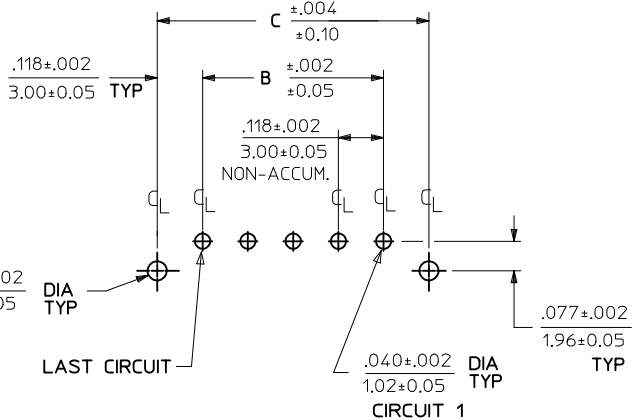
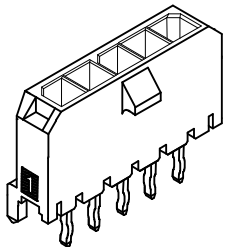
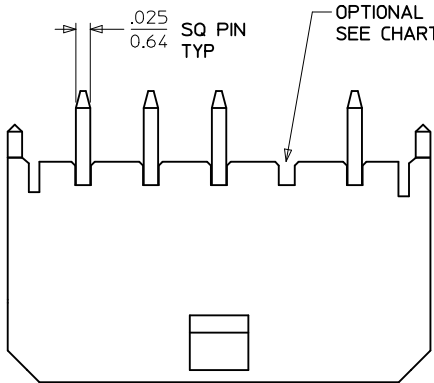

PCB LAYOUT: COMPONENT SIDE  
RECOMMENDED PCB THICKNESS: .062/1.57

CKTS	A	B	C
2	.380 9.65	.118 3.00	.354 9.00
3	.498 12.65	.236 6.00	.472 12.00
4	.616 15.65	.354 9.00	.591 15.00
5	.734 18.64	.472 12.00	.709 18.00
6	.852 21.64	.591 15.00	.827 21.00
7	.970 24.64	.709 18.00	.945 24.00
8	1.088 27.64	.827 21.00	1.063 27.00
9	1.206 30.63	.945 24.00	1.181 30.00
10	1.325 33.66	1.063 27.00	1.299 33.00
11	1.443 36.65	1.181 30.00	1.417 36.00
12	1.561 39.65	1.299 33.00	1.535 39.00

FINISH A			FINISH B			FINISH C		
CKTS	MATERIAL NO:	VOID CKT	CKTS	MATERIAL NO:	VOID CKT	CKTS	MATERIAL NO:	VOID CKT
02	43650-0215		02	43650-0216		02	43650-0217	
03	43650-0315		03	43650-0316		03	43650-0317	
04	43650-0415		04	43650-0416		04	43650-0417	
05	43650-0515		05	43650-0516		05	43650-0517	
06	43650-0615		06	43650-0616		06	43650-0617	
07	43650-0715		07	43650-0716		07	43650-0717	
08	43650-0815		08	43650-0816		08	43650-0817	
09	43650-0915		09	43650-0916		09	43650-0917	
10	43650-1015		10	43650-1016		10	43650-1017	
11	43650-1115		11	43650-1116		11	43650-1117	
12	43650-1215		12	43650-1216		12	43650-1217	
03	43650-0330	02	03			03		
04			04	43650-0431	02,03	04	43650-0430	02,03
05	43650-9915	03	05	43650-0531	03	05		
05	43650-0530	02,04	05	43650-1532	02,03,04	05		
06	43650-0630	02,04,05	06			06		
07	43650-0730	03,04,05	07			07	43650-0731	02,03 05,06
09			09	43650-0930	02,03,04 06,07,08	09		

- NOTES:
- HOUSING MATERIAL: LIQUID CRYSTAL POLYMER, GLASS FILLED, UL94V-0, COLOR: BLACK  
TERMINAL MATERIAL: BRASS ALLOY
  - FINISH:  
A = .000060/(0.00152) MIN. REFLOWED MATTE TIN OVER .000050/(0.00127) MIN. NICKEL PLATE.  
(FINISH IS BRIGHT IN APPEARANCE, THICKNESS AS APPLIED PRIOR TO REFLOW)  
B = .000015/(0.00038) MIN. SELECT GOLD IN CONTACT AREA .000100/(0.00254) MIN. SELECT MATTE TIN ON SOLDER TAILS BOTH OVER .000050/(0.00127) NICKEL OVERALL  
C = .000030/(0.00076) MIN. SELECT GOLD IN CONTACT AREA .000100/(0.00254) MIN. SELECT MATTE TIN ON SOLDER TAILS BOTH OVER .000050/(0.00127) NICKEL OVERALL
  - PRODUCT SPECIFICATION: PS-43650
  - TRAY PACKAGED : SEE MOLEX DRAWING PK-70873-0811
  - MATES WITH MICRO FIT (3.0) RECEPTACLE SERIES 43645
  - THIS PART CONFORMS TO CLASS 'B' REQUIREMENTS OF PRODUCT SPECIFICATION PS-45499-002.

ADD -1532 -0930 EC NO: UCP2017-2430 DRW:RAPPELDORN 2017/05/05 CHKD:JDFX 2017/05/05 APPR:FSMLTH 2017/05/22	QUALITY SYMBOLS ∇=0 ∇=0 ∇=0	GENERAL TOLERANCES (UNLESS SPECIFIED) <table border="1"> <tr><th colspan="2">mm</th><th colspan="2">INCH</th></tr> <tr><td>4 PLACES ±</td><td>---</td><td>±</td><td>---</td></tr> <tr><td>3 PLACES ±</td><td>---</td><td>±</td><td>.010</td></tr> <tr><td>2 PLACES ±</td><td>0.25</td><td>±</td><td>.014</td></tr> <tr><td>1 PLACE ±</td><td>0.36</td><td>±</td><td>---</td></tr> <tr><td>0 PLACE ±</td><td></td><td>±</td><td></td></tr> </table>	mm		INCH		4 PLACES ±	---	±	---	3 PLACES ±	---	±	.010	2 PLACES ±	0.25	±	.014	1 PLACE ±	0.36	±	---	0 PLACE ±		±		DIMENSION STYLE IN/MM	SCALE METRIC	DESIGN UNITS THIRD ANGLE PROJECTION
		mm		INCH																									
4 PLACES ±	---	±	---																										
3 PLACES ±	---	±	.010																										
2 PLACES ±	0.25	±	.014																										
1 PLACE ±	0.36	±	---																										
0 PLACE ±		±																											
DRAWN BY: SAMIEC CHECKED BY: MUELLER APPROVED BY: EDGLEY DATE: 2000/07/07	TITLE <b>MICRO-FIT (3.0) SINGLE ROW / VERTICAL THRU HOLE / PEGS / TRAY</b> <b>molex</b>	MATERIAL NO. <b>SEE CHART</b>	DOCUMENT NO. <b>SD-43650-006</b>	SHEET NO. <b>1 OF 1</b>																									

ANGULAR ±1/2°  
DRAFT WHERE APPLICABLE MUST REMAIN WITHIN DIMENSIONS

SIZE C THIS DRAWING CONTAINS INFORMATION THAT IS PROPRIETARY TO MOLEX INCORPORATED AND SHOULD NOT BE USED WITHOUT WRITTEN PERMISSION

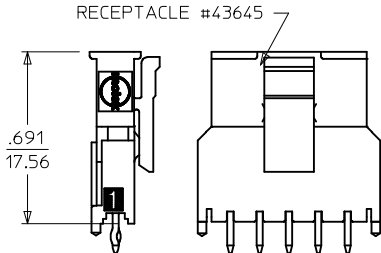
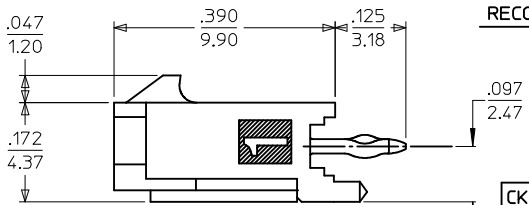
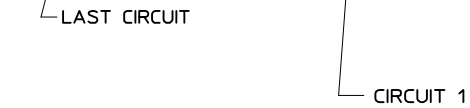
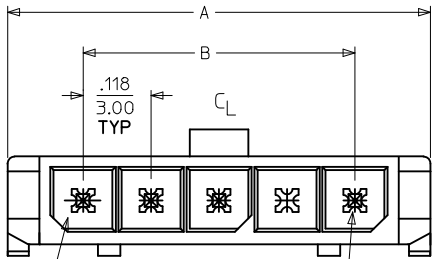
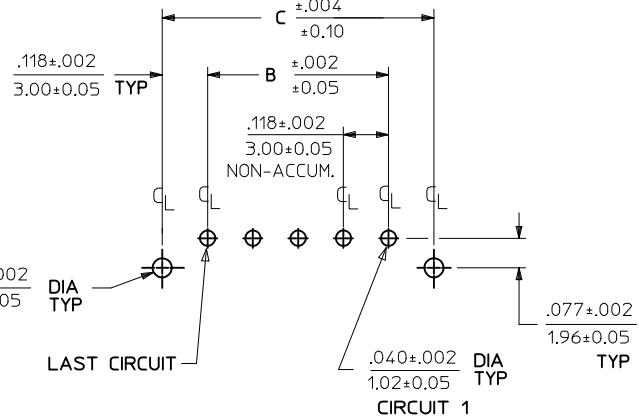
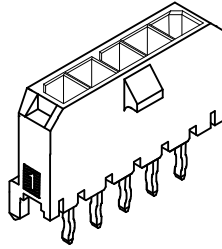
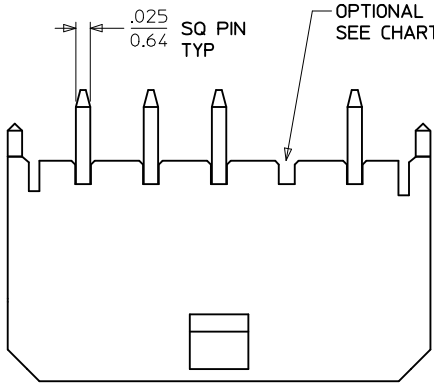

PCB LAYOUT: COMPONENT SIDE  
RECOMMENDED PCB THICKNESS: .062/1.57

CKTS	A	B	C
2	.380 9.65	.118 3.00	.354 9.00
3	.498 12.65	.236 6.00	.472 12.00
4	.616 15.65	.354 9.00	.591 15.00
5	.734 18.64	.472 12.00	.709 18.00
6	.852 21.64	.591 15.00	.827 21.00
7	.970 24.64	.709 18.00	.945 24.00
8	1.088 27.64	.827 21.00	1.063 27.00
9	1.206 30.63	.945 24.00	1.181 30.00
10	1.325 33.66	1.063 27.00	1.299 33.00
11	1.443 36.65	1.181 30.00	1.417 36.00
12	1.561 39.65	1.299 33.00	1.535 39.00

FINISH A			FINISH B			FINISH C		
CKTS	MATERIAL NO:	VOID CKT	CKTS	MATERIAL NO:	VOID CKT	CKTS	MATERIAL NO:	VOID CKT
02	43650-0215		02	43650-0216		02	43650-0217	
03	43650-0315		03	43650-0316		03	43650-0317	
04	43650-0415		04	43650-0416		04	43650-0417	
05	43650-0515		05	43650-0516		05	43650-0517	
06	43650-0615		06	43650-0616		06	43650-0617	
07	43650-0715		07	43650-0716		07	43650-0717	
08	43650-0815		08	43650-0816		08	43650-0817	
09	43650-0915		09	43650-0916		09	43650-0917	
10	43650-1015		10	43650-1016		10	43650-1017	
11	43650-1115		11	43650-1116		11	43650-1117	
12	43650-1215		12	43650-1216		12	43650-1217	
03	43650-0330	02	03			03		
04			04	43650-0431	02.03	04	43650-0430	02.03
05	43650-9915	03	05	43650-0531	03	05		
05	43650-0530	02,04	05	43650-1532	02,03,04	05		
06	43650-0630	02,04,05	06			06		
07	43650-0730	03,04,05	07			07	43650-0731	02.03 05.06
09			09	43650-0930	02,03,04 06,07,08	09		

- NOTES:**
- HOUSING MATERIAL: LIQUID CRYSTAL POLYMER, GLASS FILLED, UL94V-0, COLOR: BLACK  
TERMINAL MATERIAL: BRASS ALLOY
  - FINISH:  
A = .000060/(0.00152) MIN. REFLOWED MATTE TIN OVER .000050/(0.00127) MIN. NICKEL PLATE.  
(FINISH IS BRIGHT IN APPEARANCE, THICKNESS AS APPLIED PRIOR TO REFLOW)  
B = .000015/(0.00038) MIN. SELECT GOLD IN CONTACT AREA .000100/(0.00254) MIN. SELECT MATTE TIN ON SOLDER TAILS BOTH OVER .000050/(0.00127) NICKEL OVERALL  
C = .000030/(0.00076) MIN. SELECT GOLD IN CONTACT AREA .000100/(0.00254) MIN. SELECT MATTE TIN ON SOLDER TAILS BOTH OVER .000050/(0.00127) NICKEL OVERALL
  - PRODUCT SPECIFICATION: PS-43650
  - TRAY PACKAGED : SEE MOLEX DRAWING PK-70873-0811
  - MATES WITH MICRO FIT (3.0) RECEPTACLE SERIES 43645
  - THIS PART CONFORMS TO CLASS 'B' REQUIREMENTS OF PRODUCT SPECIFICATION PS-45499-002.

ADD -1532 -0930 EC NO: UCP2017-2430 DRWNS:APPELDORN 2017/05/05 CHKD:JDFDX 2017/05/05 APPR:FSMLTH 2017/05/22 F3	QUALITY SYMBOLS ∇=0 ∇=0 ∇=0	GENERAL TOLERANCES (UNLESS SPECIFIED)	DIMENSION STYLE <b>IN/MM</b>	SCALE DESIGN UNITS <b>METRIC</b>	THIRD ANGLE PROJECTION																			
		<table border="1"> <tr><th></th><th>mm</th><th>INCH</th></tr> <tr><td>4 PLACES ±</td><td>---</td><td>±---</td></tr> <tr><td>3 PLACES ±</td><td>---</td><td>±.010</td></tr> <tr><td>2 PLACES ±</td><td>0.25</td><td>±.014</td></tr> <tr><td>1 PLACE ±</td><td>0.36</td><td>±---</td></tr> <tr><td>0 PLACE ±</td><td></td><td>±</td></tr> </table>		mm	INCH	4 PLACES ±	---	±---	3 PLACES ±	---	±.010	2 PLACES ±	0.25	±.014	1 PLACE ±	0.36	±---	0 PLACE ±		±	DRAWN BY SAMIEC	DATE 2000/07/07	TITLE <b>MICRO-FIT (3.0) SINGLE ROW / VERTICAL THRU HOLE / PEGS / TRAY</b>	
			mm	INCH																				
4 PLACES ±	---	±---																						
3 PLACES ±	---	±.010																						
2 PLACES ±	0.25	±.014																						
1 PLACE ±	0.36	±---																						
0 PLACE ±		±																						
ANGULAR ±1/2° DRAFT WHERE APPLICABLE MUST REMAIN WITHIN DIMENSIONS	CHECKED BY MUELLER	DATE 2000/07/07	<b>molex</b> DOCUMENT NO. <b>SD-43650-006</b> SHEET NO. <b>1 OF 1</b>		THIS DRAWING CONTAINS INFORMATION THAT IS PROPRIETARY TO MOLEX INCORPORATED AND SHOULD NOT BE USED WITHOUT WRITTEN PERMISSION																			