

产品编号 : 501338000

Product Description : 1.25mm Pitch,
PicoBlade Male Crimp Terminal, Tin (Sn)
Plating, 28-32 AWG, Reel

系列号 : 50133

状态 : Active

Product Category : Crimp Terminals

Packaging Alternative : 0501338100 (Bag)



文件和资源

图纸

图纸 501338000_sd.pdf

3D 模型和设计文件

3D模型 501338000_stp.zip

规格

应用规格 510210001-AS-000.pdf

包装规格 501339200-SPK-200.pdf

产品规格 510211009-PS-000.pdf

产品规格 510211109-PS-000.pdf

产品规格 PS-51021-009-001.pdf

模具规格

压接规格 CS-50125_50133-001.pdf

产物环境合规

合规

GADSL/IMDS	Compliant with Exemption 44
China RoHS	
EU ELV	Not Relevant
Low-Halogen Status	Low-Halogen per IEC 61249-2-21
REACH SVHC	Not Contained per D(2023)3788-DC (14 Jun 2023)
EU RoHS	Compliant per EU 2015/863

多部分产品合规性声明

- Eu RoHS
- REACH SVHC
- Low-Halogen

多部分行业合规性文件

- IPC 1752A Class C
- IPC 1752A Class D
- Molex Product Compliance Declaration
- IEC-62474
- chemSHERPA (xml)

欧盟 RoHS 合格证书

产品详情

常规

状态	活动
类别	Crimp Terminals
系列	50133
说明	1.25mm Pitch, PicoBlade Male Crimp Terminal, Tin (Sn) Plating, 28-32 AWG, Reel
应用	Signal, Wire-to-Wire
产品系列	PicoBlade Connector System
产品名称	PicoBlade
UPC	800753576131

电气

每触点最大电流	0.8A, 1.0A
电压 - 最大	125V

物理

性别	男
材料 - 金属	Phosphor Bronze
材料 - 接合部位电镀	Tin
材料 - 终端电镀	Tin
净重	15.916/mg
包装形式	Reel
最薄镀层 - 接合部位	0.889µm

最薄镀层 - 端接	0.914µm
终端界面类型	Crimp or Compression
导线绝缘直径	0.50-1.00mm
线径规格 (AWG)	28, 30, 32
线缆尺寸mm ²	不适用

可连接使用部件

描述	产品编号
PicoBlade Single Row Plug Housings	<u>51047</u>

施工工具

全局

描述	产品编号
Extraction Tool for Micro-Fit Terminals	<u>0011030043</u>
Hand Crimp Tool for 1.25mm Pitch PicoBlade Crimp Terminals, 26-32 AWG	<u>2002182000</u>
FineAdjust Applicator for 1.25mm (.049") Pitch Wire-to-Wire Crimp Terminals, 26-32 AWG	<u>2037025900</u>
T2 Terminator Tooling Die	<u>0639104200</u>

施工工具

日本

描述	产品编号
Extraction Tool	<u>0570726000</u>
S-1 Applicator for PicoBlade Terminals, 26-28 AWG and 28-32 AWG	<u>0571383700</u>

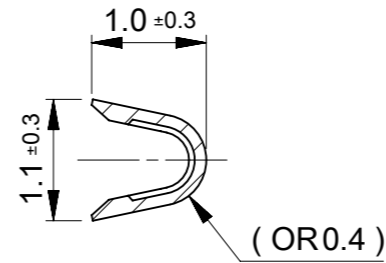
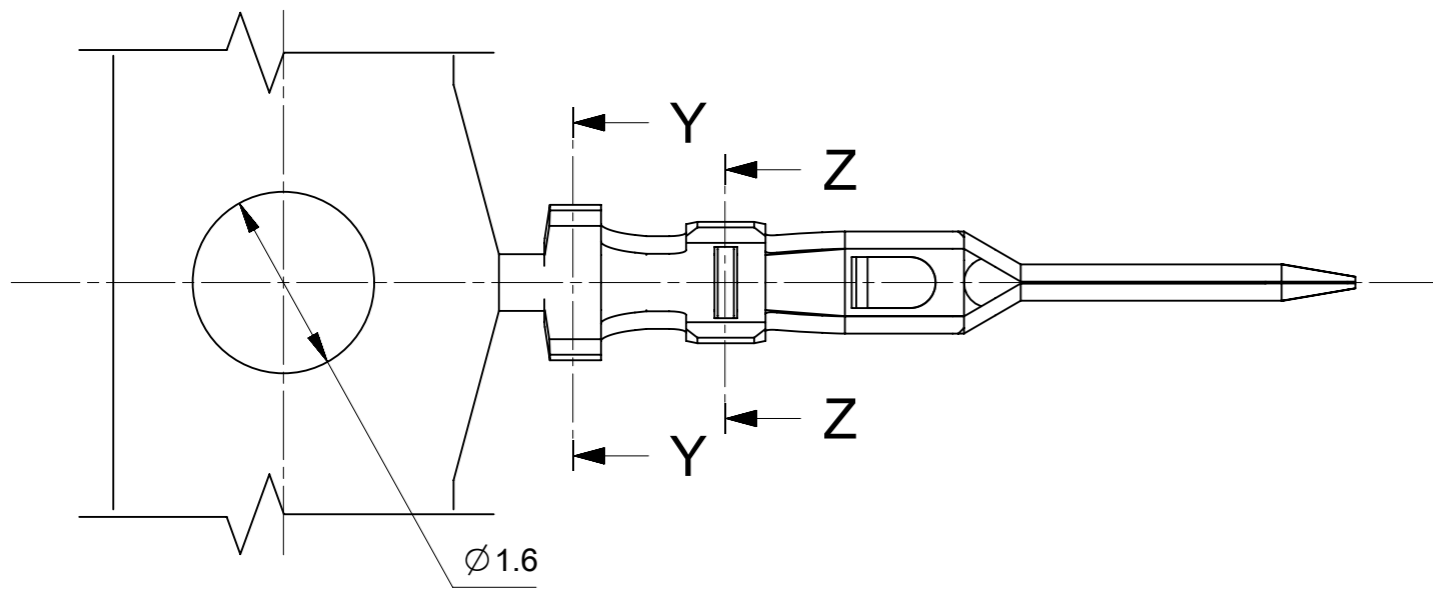

SECTION Z-Z

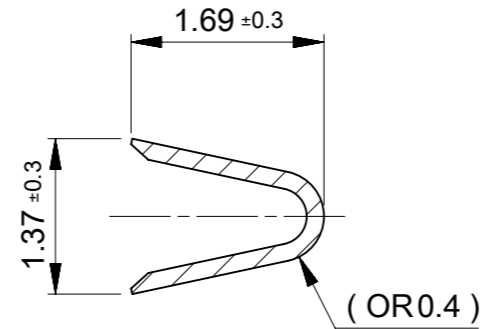

SECTION Y-Y

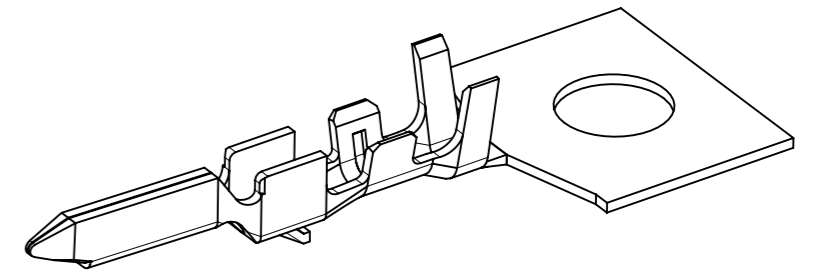

NOTE

- ① 材料及び仕上げ(めっき仕様) : TABLE 1 参照
MATERIAL AND FINISHES : SEE TABLE 1
- ② 適合製品および各種仕様書についてはSHEET 2 を参照。
PLEASE REFER TO SHEET 2 FOR APPLICABLE PRODUCTS AND SPECIFICATIONS.

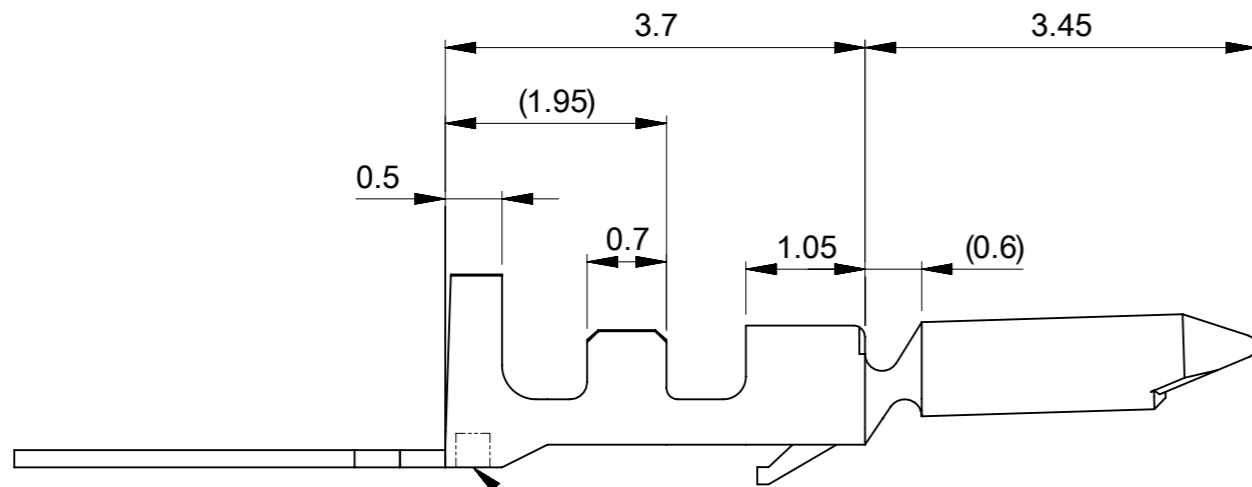

トレードマーク
TRADE MARK

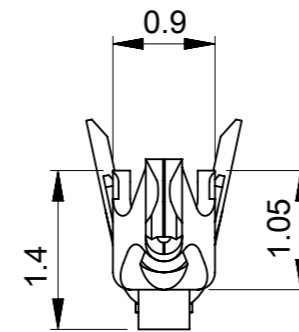

① **TABLE 1**

部品 PART	材質 MATERIAL
ターミナル TERMINAL	りん青銅 PHOSPHOR BRONZE 錫めっき 0.9 MICROMETER MINIMUM (リフロー処理、前めっき) TIN PLATING 0.9 MICROMETER MINIMUM (REFLOW TREATMENT, PRE-PLATED)

DOCUMENT STATUS | P1 | RELEASE DATE | 2022/04/19 08:41:19

Φ0.5-Φ1.0	AWG#28-32	ポリ袋 POLYBAG	バラ状 LOOSE	501338100
		リール REEL	連鎖状 CHAIN	501338000
被覆外径 INSULATION RANGE	適用電線範囲 WIRE RANGE	梱包形態 PACKING	端子形状 FORM	オーダー番号 ORDER NO

THIS DRAWING CONTAINS INFORMATION THAT IS PROPRIETARY TO MOLEX ELECTRONIC TECHNOLOGIES, LLC AND SHOULD NOT BE USED WITHOUT WRITTEN PERMISSION

DIMENSION UNITS	SCALE	CURRENT REV DESC: REVISED		
mm	NTS	molex		
GENERAL TOLERANCES (UNLESS SPECIFIED)				
ANGULAR TOL	± 3.0 °	PICOBLADE 1.25 PLUG CRIMP TERMINAL TIN PLATING AWG28-32		
4 PLACES	± 0.2	PRODUCT CUSTOMER DRAWING		
3 PLACES	± 0.2	DOCUMENT NUMBER		
2 PLACES	± 0.2	501330000-SD		
1 PLACE	± 0.2	DOC TYPE		
0 PLACES	± 0.2	PSD		
DRAFT WHERE APPLICABLE MUST REMAIN WITHIN DIMENSIONS		THIRD ANGLE PROJECTION	DRAWING	SHEET NUMBER
			A3-SIZE	1 OF 2

△ 2 適合製品および各種仕様書
 APPLICABLE PRODUCTS AND SPECIFICATIONS

梱包仕様書 PACKING SPECIFICATION		PART NUMBER 501338*00		SPECIFICATION NUMBER 501339200-SPK 200	
適合ハウジング APPLICABLE HOUSING		PART NUMBER 51047**00			
適合嵌合相手 MATE WITH		PART NUMBER 51021**00			
適合圧着端子 APPLICABLE TERMINAL	PLATING TYPE	TIN			
	PART NUMBER	500798*00	500588*00	500798001	500588001
	WIRE SIZE (AWG)	#26-28	#28-32	#26-28	#28-32
製品仕様書 PRODUCT SPECIFICATION		PS-51021-009 PS 001		510211109-PS PS 000	
アプリケーション仕様書 (取扱説明書) APPLICATION SPECIFICATION		510210001-AS PS 000			

製品嵌合図は各"適合嵌合相手"図面参照のこと
 MATING VIEW: REFER TO EACH "MATE WITH" PART DRAWING.

THIS DRAWING CONTAINS INFORMATION THAT IS PROPRIETARY TO MOLEX ELECTRONIC TECHNOLOGIES, LLC AND SHOULD NOT BE USED WITHOUT WRITTEN PERMISSION									
DIMENSION UNITS	SCALE	CURRENT REV DESC: REVISED					molex		
mm	NTS								
GENERAL TOLERANCES (UNLESS SPECIFIED)							PICOBLADE 1.25 PLUG CRIMP TERMINAL TIN PLATING AWG28-32		
ANGULAR TOL	± 3.0 °						PRODUCT CUSTOMER DRAWING		
4 PLACES	± 0.2	EC NO: 698818							
3 PLACES	± 0.2	DRWN: HHUSSIN			2022/02/16				
2 PLACES	± 0.2	CHK'D: SAKIYAMA			2022/04/19				
1 PLACE	± 0.2	APPR: AIDA			2022/04/19				
0 PLACES	± 0.2	INITIAL REVISION:							
DRAFT WHERE APPLICABLE MUST REMAIN WITHIN DIMENSIONS		DRWN: QHE31			2021/12/15	DOCUMENT NUMBER	DOC TYPE	DOC PART	REVISION
		APPR: KOMURAKAMI			2021/12/24	501330000-SD	PSD	000	B
		THIRD ANGLE PROJECTION	DRAWING	SERIES	MATERIAL NUMBER	CUSTOMER		SHEET NUMBER	
			A3-SIZE	50133	SEE CHART			2 OF 2	