



产品编号 : [5023860870](#)

Product Description : 1.25mm Pitch CLIK-Mate Wire-to-Board PCB Receptacle, Single Row, Right-Angle, Tin (Sn) Plating, 8 Circuits

系列号 : 502386

状态 : Active

Product Category : PCB Headers and Receptacles

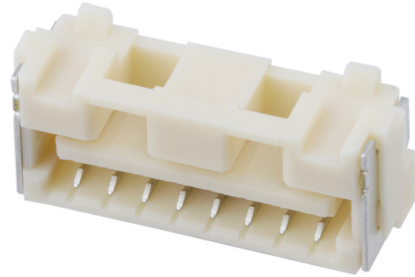

文件和资源

图纸

[图纸 5023860870_sd.pdf](#)

3D 模型和设计文件

[3D模型 5023860870_stp.zip](#)

规格

[应用规格 AS-502380-002-001.pdf](#)

[包装规格 SPK-502386-001-001.pdf](#)

[产品规格 PS-502382-001-001.pdf](#)

产物环境合规

合规

GADSL/IMDS	Not Relevant
China RoHS	
EU ELV	Not Relevant
Low-Halogen Status	Not Low-Halogen per IEC 61249-2-21
REACH SVHC	Not Contained per D(2023)3788-DC (14 Jun 2023)
EU RoHS	Compliant per EU 2015/863

多部分产品合规性声明

- Eu RoHS
- REACH SVHC
- Low-Halogen

多部分行业合规性文件

- IPC 1752A Class C
- IPC 1752A Class D
- Molex Product Compliance Declaration
- IEC-62474
- chemSHERPA (xml)

欧盟 RoHS 合格证书

产品详情

常规

状态	活动
类别	PCB Headers and Receptacles
系列	502386
说明	1.25mm Pitch CLIK-Mate Wire-to-Board PCB Receptacle, Single Row, Right-Angle, Tin (Sn) Plating, 8 Circuits
应用	Signal, Wire-to-Board
元件类型	PCB Receptacle
产品系列	CLIK-Mate Wire-to-Board Connectors
产品名称	CLIK-Mate
UPC	822350895736

机构

UL	E29179
----	--------

电气

每触点最大电流	1.0A
电压 - 最大	50V AC (RMS)/DC

物理

回路数 (已载入)	8
电路数 (最多)	8
颜色-树脂	Natural
耐用性(插拔次数) - 最多次数	30
符合灼热丝规范	否

可配插产品指南	是
插接极性	是
锁定插接部位	是
插配长度	5.55mm
材料 - 金属	Copper Alloy
材料 - 接合部位电镀	Tin
材料 - 终端电镀	Tin
材料 - 树脂	High Temperature Thermoplastic
净重	380.801/mg
行数	1
方向	Right Angle
包装形式	Embossed Tape on Reel
PCB 定位器	否
PCB 保持力	是
间距 - 插配接口	1.25mm
间距 - 终端界面	1.25mm
最薄镀层 - 接合部位	1.016µm
最薄镀层 - 端接	1.016µm
有极性的插配件	是
PCB 极性	否
可堆叠的	否
运行温度范围	-40° to +105° C
终端界面类型	Surface Mount

可配插/可连接使用的产品

可配插部件

描述	产品编号
1.25mm Pitch CLIK-Mate Single Row Plug Housings	<u>502380</u>
CLIK-Mate-to-CLIK-Mate Off-the-Shelf (OTS) Cable Assemblies	<u>224091</u>
CLIK-Mate-to-Pigtail Off-the-Shelf (OTS) Cable Assemblies	<u>224092</u>

This document was generated on Jan 30, 2024

10 9 8 7 6 5 4 3 2 1

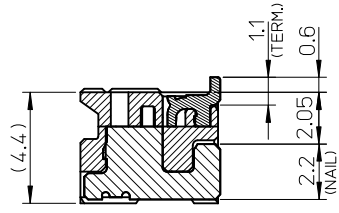
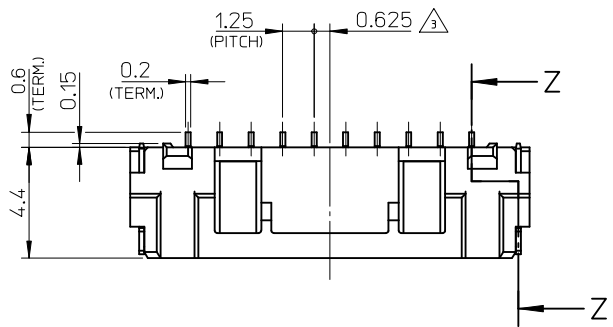

SECTION Z-Z

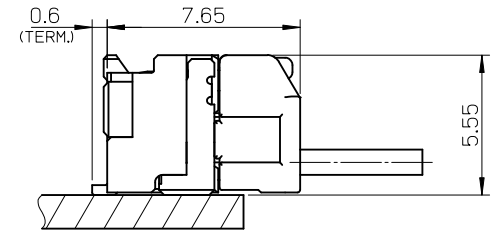
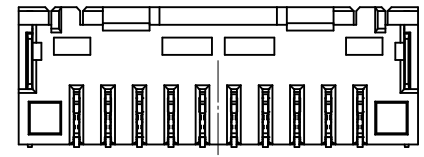
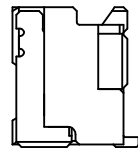
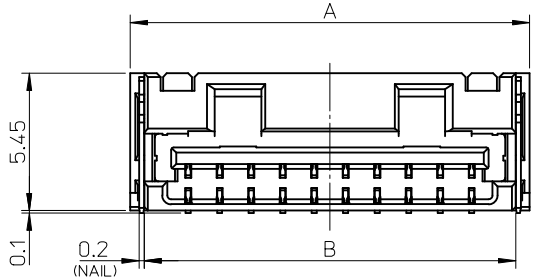
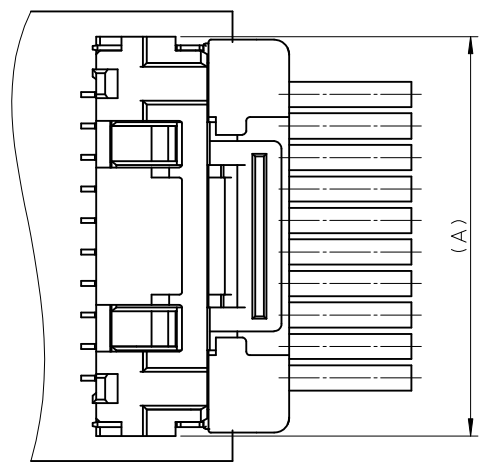

嵌合部
MATED CONNECTORS

NOTES

1. 嵌合相手: 502380-****
MATE WITH : 502380-****
2. 端子テール部 及び ネイルの平坦度: 0.1MAX.
TAIL AND NAIL COPLANARITY TO BE 0.1 MAX.
3. 極数/2=偶数に適用。
APPLY FOR CKT. SIZE / 2 = EVEN.
4. 端子テール部 及び ネイルに錫めっきを使用しているため、
外観に摺動痕が付く場合が御座います。
THE WOUND OF FRICTION MIGHT ADHERE TO EXTERNALS
BECAUSE THE TIN PLATING IS USED FOR THE TAIL AND NAIL.
5. 本製品のプラスチック部に黒点等が確認される場合や
色合いが異なる場合がありますが、製品性能に影響はありません。
THERE IS NO INFLUENCE IN THE PRODUCT PERFORMANCE THOUGH
THE BLACK SPOT ETC. MIGHT BE CONFIRMED TO THE PLASTIC PART
OF THIS PRODUCT AND THE SHADE MIGHT BE DIFFERENT.

2	10.7	11.5	17.5	21	22.1	502386-15**	15
2	9.45	10.25	16.25	19.75	20.85	502386-14**	14
2	8.2	9	15	18.5	19.6	502386-13**	13
2	6.95	7.75	13.75	17.25	18.35	502386-12**	12
2	5.7	6.5	12.5	16	17.1	502386-11**	11
2	4.45	5.25	11.25	14.75	15.85	502386-10**	10
2	3.2	4	10	13.5	14.6	502386-09**	9
2.6	1.95	2.75	8.75	12.25	13.35	502386-08**	8
F	E	D	C	B	A	EMBOSSED TAPE PACKAGE オーダー番号 ORDER No.	極数 CKT. NO.

番号 NO.	部品 PART	材質 MATERIAL
①	ハウジング HOUSING	耐熱性樹脂 UL94V-0 色:SHEET 3 参照 HEATPROOF RESIN UL94V-0 COLOR : SEE SHEET 3
②	ターミナル TERMINAL	銅合金 COPPER ALLOY 錫めっき : 1.0 micro-meter MIN. TIN (TAIL AREA) ニッケルめっき(下地): 1.0 micro-meter MIN. NICKEL (UNDER PLATING)
③	ネイル NAIL	銅合金 COPPER ALLOY 錫めっき: 1.0 micro-meter MIN. TIN ニッケルめっき(下地): 1.0 micro-meter MIN. NICKEL (UNDER PLATING)

REVISED EC NO.: J2013-0870 DRWN: KWASHIO 2013/02/07 CHKD: KASAKAWA 2013/02/13 APPR: Y01TO 2013/02/13	DESCRIPTION REV	GENERAL TOLERANCES (UNLESS SPECIFIED)		DIMENSION STYLE MM ONLY		SCALE 5:1	DESIGN UNITS METRIC	THIRD ANGLE PROJECTION	
		10 UNDER	±0.2	DRAWN BY T. MIYAZAKI	DATE 2006/08/28	TITLE 1.25 W/B CONN. SINGLE R/A REC. ASS'Y 8-15CKT. -LEAD FREE-			
		10 OVER 30 UNDER	±0.25	CHECKED BY K. ASAKAWA	DATE 2006/08/28				
		30 OVER	±0.3	APPROVED BY Y0. ITO	DATE 2006/08/28				
ANGULAR ±3 °		DRAFT WHERE APPLICABLE MUST REMAIN WITHIN DIMENSIONS		MATERIAL NO. SEE TABLE		DOCUMENT NO. SD-502386-002		SHEET NO. 1 OF 3	
SIZE A3 THIS DRAWING CONTAINS INFORMATION THAT IS PROPRIETARY TO MOLEX INCORPORATED AND SHOULD NOT BE USED WITHOUT WRITTEN PERMISSION									

9 8 7 6 5 4 3 2

10 9 8 7 6 5 4 3 2 1

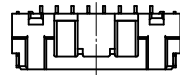

8 CKT.

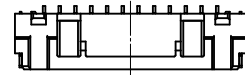

12 CKT.

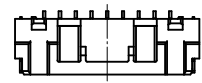

9 CKT.

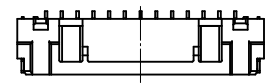

13 CKT.

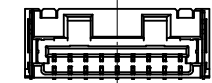

10 CKT.

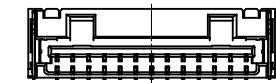

14 CKT.

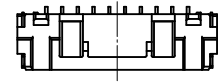

11 CKT.

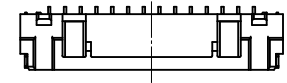

15 CKT.

極数の種類

KIND OF CKT. NO. (FRONT VIEW)

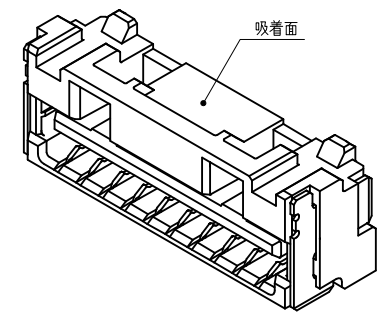
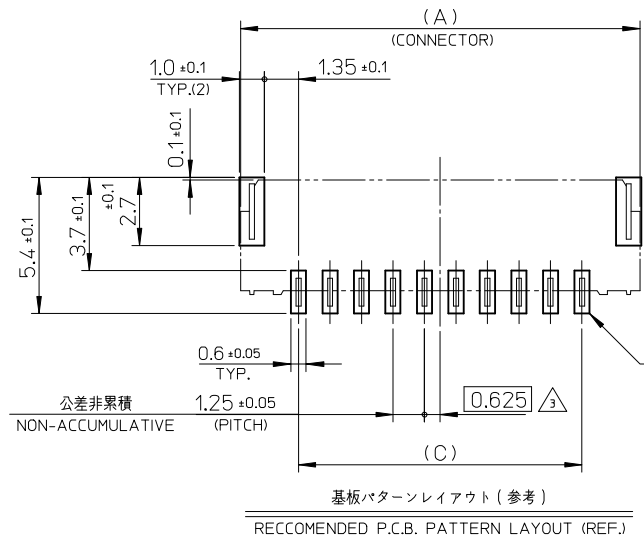
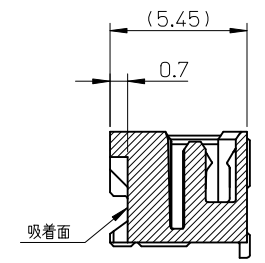
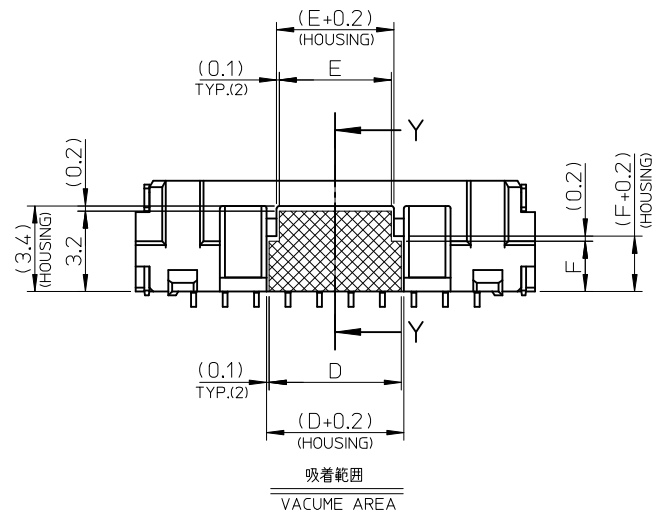

REVISED EC NO.: J2013-0870 DRWN: KASHIO 2013/02/07 CHKD: KASAKAWA 2013/02/13 APPR: Y. ITO 2013/02/13	GENERAL TOLERANCES (UNLESS SPECIFIED)		DIMENSION STYLE MM ONLY	SCALE 5:1	DESIGN UNITS METRIC	THIRD ANGLE PROJECTION
	10 UNDER	±0.2	DRAWN BY T. MIYAZAKI	DATE 2006/08/28	TITLE 1.25 W/B CONN. SINGLE R/A REC. ASS'Y 8-15CKT. -LEAD FREE-	
	10 OVER 30 UNDER	±0.25	CHECKED BY K. ASAKAWA	DATE 2006/08/28		
	30 OVER	±0.3	APPROVED BY Y. ITO	DATE 2006/08/28		
ANGULAR	±3 °	MATERIAL NO. SEE TABLE		DOCUMENT NO. SD-502386-002	SHEET NO. 2 OF 3	
DRAFT WHERE APPLICABLE MUST REMAIN WITHIN DIMENSIONS		SIZE A3	THIS DRAWING CONTAINS INFORMATION THAT IS PROPRIETARY TO MOLEX INCORPORATED AND SHOULD NOT BE USED WITHOUT WRITTEN PERMISSION			

9 8 7 6 5 4 3 2

HSG COLOR : ORANGE		
--	502386-**28	15
--		14
--		13
--		12
--		11
--		10
502386-0948		9
--		8
EMBOSSED TAPE PACKAGE オーダー番号ORDER No.	コネクタ シリーズ CONNECTOR SERIES	極数 Ckt. No.

HSG COLOR : GREEN		HSG COLOR : BLUE		HSG COLOR : YELLOW		HSG COLOR : RED		HSG COLOR : BLACK		HSG COLOR : NATURAL		
502386-1546	502386-**26	502386-1544	502386-**24	--	502386-**23	502386-1542	502386-**22	502386-1541	502386-**21	502386-1570	502386-**09	
502386-1446		502386-1444		--		502386-1442		502386-1441		502386-1470		
502386-1346		502386-1344		--		502386-1342		502386-1341		502386-1370		
502386-1246		502386-1244		--		502386-1242		502386-1241		502386-1270		
502386-1146		502386-1144		--		502386-1142		502386-1141		502386-1170		
502386-1046		502386-1044		--		502386-1042		502386-1041		502386-1070		
502386-0946		502386-0944		502386-0943		502386-0942		502386-0941		502386-0970		
502386-0846		502386-0844		--		502386-0842		502386-0841		502386-0870		
EMBOSSED TAPE PACKAGE オーダー番号ORDER No.	コネクタ シリーズ CONNECTOR SERIES	EMBOSSED TAPE PACKAGE オーダー番号ORDER No.	コネクタ シリーズ CONNECTOR SERIES	EMBOSSED TAPE PACKAGE オーダー番号ORDER No.	コネクタ シリーズ CONNECTOR SERIES	EMBOSSED TAPE PACKAGE オーダー番号ORDER No.	コネクタ シリーズ CONNECTOR SERIES	EMBOSSED TAPE PACKAGE オーダー番号ORDER No.	コネクタ シリーズ CONNECTOR SERIES	EMBOSSED TAPE PACKAGE オーダー番号ORDER No.	コネクタ シリーズ CONNECTOR SERIES	極数 Ckt. No.

REVISED EC NO. J2013-0870 DRWN:KASHIO 2013/02/07 CHKD:KASAKAWA 2013/02/13 APPR:Y.ITO 2013/02/13	GENERAL TOLERANCES (UNLESS SPECIFIED)		DIMENSION STYLE	SCALE	DESIGN UNITS	THIRD ANGLE PROJECTION 1.25 W/B CONN. SINGLE R/A REC. ASS'Y 8-15CKT. -LEAD FREE- molex SD-502386-002
	MM ONLY		-----	METRIC	⊙ □	
	10 UNDER ±0.2	10 OVER 30 UNDER ±0.25	30 OVER ±0.3	DRAWN BY DATE	T.MIYAZAKI 2006/08/28	
	ANGULAR ±3 °		DRAFT WHERE APPLICABLE MUST REMAIN WITHIN DIMENSIONS	CHECKED BY DATE	K.ASAKAWA 2006/08/28	
			APPROVED BY DATE	Y.O.ITO 2006/08/28		
			MATERIAL NO.	SEE TABLE	DOCUMENT NO.	SHEET NO.
			SIZE	A3	3 OF 3	

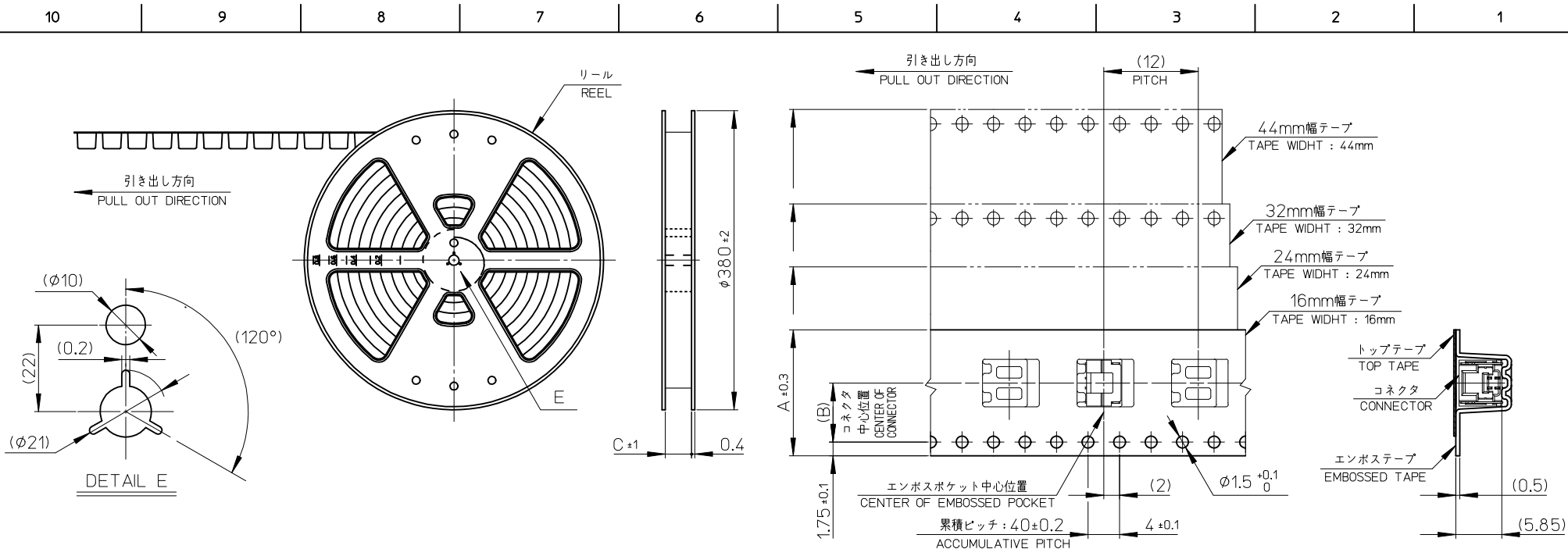

NOTES

- 製品詳細寸法については、SD-502386-001, -002 を参照下さい。
PLEASE REFER TO SD-502386-001, -002 FOR THE DETAILED DIMENSION OF THE CONNECTOR.
- 梱包数量 : 1200個
NUMBER OF CONNECTORS : 1200 PIECES/REEL.
- リードテープ長さ
LEAD TAPE LENGTH

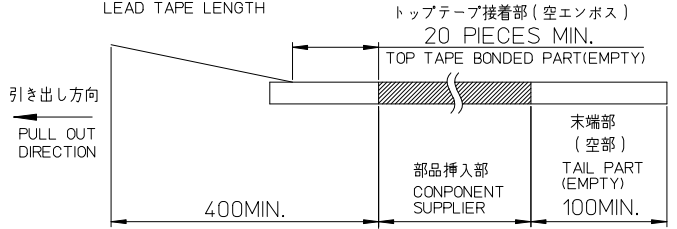

- 材料
MATERIAL
キャリアテープ : ポリスチレン
CARRIER TAPE : POLYSTYRENE
トップテープ : ポリエステル, ポリエチレン, ポリエチレンテレフタレート
TOP TAPE : POLYESTER, POLYETHYLENE, POLYETHYLENE TEREPHTHALATE
リール : ポリスチレン <リサイクル材を含む>
REEL : POLYSTYRENE <RECYCLE MATERIAL CONTAINED>
- ELV 及び RoHS 適合品
ELV AND RoHS COMPLIANT

45.5	20.2	44	502386-15**	15
45.5	20.2	44	502386-14**	14
33.5	14.2	32	502386-13**	13
33.5	14.2	32	502386-12**	12
33.5	14.2	32	502386-11**	11
33.5	14.2	32	502386-10**	10
25.5	11.5	24	502386-09**	9
25.5	11.5	24	502386-08**	8
25.5	11.5	24	502386-07**	7
25.5	11.5	24	502386-06**	6
25.5	11.5	24	502386-05**	5
25.5	11.5	24	502386-04**	4
17.5	7.5	16	502386-03**	3
17.5	7.5	16	502386-02**	2

REVISED EC NO: J2013-0870 DRWN: KWASHIO 2013/02/07 CHKD: KASAKAWA 2013/02/13 APPR: YO ITO 2013/02/13	DESCRIPTION GENERAL TOLERANCES (UNLESS SPECIFIED) 10 UNDER ±0.2 10 OVER 30 UNDER ±0.25 30 OVER ±0.3 ANGULAR ±3 ° DRAFT WHERE APPLICABLE MUST REMAIN WITHIN DIMENSIONS	DIMENSION STYLE MM ONLY	SCALE ---	DESIGN UNITS METRIC	THIRD ANGLE PROJECTION	
		DRAWN BY T. MIYAZAKI	DATE 2006/10/16	TITLE 1.25 W/B CONN. SINGLE R/A REC. EMBTP PKG		
		CHECKED BY K. ASAKAWA	DATE 2006/10/16	molex		
		APPROVED BY YO. ITO	DATE 2006/10/16	MATERIAL NO. SEE TABLE	DOCUMENT NO. SD-502386-003	SHEET NO. 1 OF 2
THIS DRAWING CONTAINS INFORMATION THAT IS PROPRIETARY TO MOLEX INCORPORATED AND SHOULD NOT BE USED WITHOUT WRITTEN PERMISSION						

WITHOUT CAPTON TAPE			WITH CAPTON TAPE										
HSG COLOR : ORANGE			HSG COLOR : GREEN		HSG COLOR : BLUE		HSG COLOR : RED		HSG COLOR : BLACK		HSG COLOR : NATURAL		
502386-**28	--//	15	--//	--//	--//	--//	--//	--//	--//	--//	--//	--//	15
	--//	14	--//	--//	--//	--//	--//	--//	--//	--//	--//	--//	14
	--//	13	--//	--//	--//	--//	--//	--//	--//	--//	--//	--//	13
	--//	12	--//	--//	--//	--//	--//	--//	--//	--//	--//	--//	12
	--//	11	--//	--//	--//	--//	--//	--//	--//	--//	--//	--//	11
	--//	10	--//	--//	--//	--//	--//	--//	--//	--//	--//	--//	10
	502386-0948	9	--//	--//	--//	--//	--//	--//	--//	--//	--//	--//	9
	--//	8	--//	--//	--//	--//	--//	--//	--//	--//	--//	--//	8
	--//	7	--//	--//	--//	--//	--//	--//	--//	--//	--//	--//	7
	--//	6	--//	--//	--//	--//	--//	--//	--//	--//	--//	--//	6
--//	5	502386-0736	502386-0636	502386-0734	502386-0634	502386-0732	502386-0632	502386-0731	502386-0631	502386-0731	502386-0631	502386-0772	7
--//	4	502386-0536	502386-0436	502386-0534	502386-0434	502386-0532	502386-0432	502386-0531	502386-0431	502386-0531	502386-0431	502386-0572	5
--//	3	502386-0436	502386-0336	502386-0434	502386-0334	502386-0432	502386-0332	502386-0431	502386-0331	502386-0431	502386-0331	502386-0472	4
--//	2	502386-0336	502386-0236	502386-0334	502386-0234	502386-0332	502386-0232	502386-0331	502386-0231	502386-0331	502386-0231	502386-0372	3
--//	2	502386-0236	502386-0136	502386-0234	502386-0134	502386-0232	502386-0132	502386-0231	502386-0131	502386-0231	502386-0131	502386-0272	2
コネクタ シリーズ CONNECTOR SERIES	製品番号 MATERIAL NO.	極数 (KT. NO.)	コネクタ シリーズ CONNECTOR SERIES	製品番号 MATERIAL NO.	コネクタ シリーズ CONNECTOR SERIES	製品番号 MATERIAL NO.	コネクタ シリーズ CONNECTOR SERIES	製品番号 MATERIAL NO.	コネクタ シリーズ CONNECTOR SERIES	製品番号 MATERIAL NO.	コネクタ シリーズ CONNECTOR SERIES	製品番号 MATERIAL NO.	極数 (KT. NO.)

WITHOUT CAPTON TAPE																	
HSG COLOR : GREEN			HSG COLOR : BLUE			HSG COLOR : YELLOW			HSG COLOR : RED			HSG COLOR : BLACK			HSG COLOR : NATURAL		
502386-**26	502386-1546	502386-1544	--//	502386-1542	502386-1541	502386-1570	15										
	502386-1446	502386-1444	--//	502386-1442	502386-1441	502386-1470	14										
	502386-1346	502386-1344	--//	502386-1342	502386-1341	502386-1370	13										
	502386-1246	502386-1244	--//	502386-1242	502386-1241	502386-1270	12										
	502386-1146	502386-1144	--//	502386-1142	502386-1141	502386-1170	11										
	502386-1046	502386-1044	--//	502386-1042	502386-1041	502386-1070	10										
	502386-0946	502386-0944	502386-0943	502386-0942	502386-0941	502386-0970	9										
	502386-0846	502386-0844	--//	502386-0842	502386-0841	502386-0870	8										
	502386-0746	502386-0744	--//	502386-0742	502386-0741	502386-0770	7										
	502386-0646	502386-0644	--//	502386-0642	502386-0641	502386-0670	6										
	502386-0546	502386-0544	--//	502386-0542	502386-0541	502386-0570	5										
	502386-0446	502386-0444	--//	502386-0442	502386-0441	502386-0470	4										
	502386-0346	502386-0344	--//	502386-0342	502386-0341	502386-0370	3										
	502386-0246	502386-0244	--//	502386-0242	502386-0241	502386-0270	2										
	コネクタ シリーズ CONNECTOR SERIES	製品番号 MATERIAL NO.	コネクタ シリーズ CONNECTOR SERIES	製品番号 MATERIAL NO.	コネクタ シリーズ CONNECTOR SERIES	製品番号 MATERIAL NO.	コネクタ シリーズ CONNECTOR SERIES	製品番号 MATERIAL NO.	コネクタ シリーズ CONNECTOR SERIES	製品番号 MATERIAL NO.	コネクタ シリーズ CONNECTOR SERIES	製品番号 MATERIAL NO.	極数 (KT. NO.)				

REVISED EC NO. J2013-0870 DRWN:KAWASHIO 2013/02/13 CHKD:KASAKAWA 2013/02/13 APPR:Y01TO 2013/02/13	GENERAL TOLERANCES (UNLESS SPECIFIED)		DIMENSION STYLE MM ONLY		SCALE ---	DESIGN UNITS METRIC	THIRD ANGLE PROJECTION
	10 UNDER	±0.2	DRAWN BY T. MIYAZAKI	DATE 2006/10/16	TITLE 1.25 W/B CONN. SINGLE R/A REC. EMBTP PKG		
	10 OVER 30 UNDER	±0.25	CHECKED BY K. ASAKAWA	DATE 2006/10/16			
	30 OVER	±0.3	APPROVED BY Y0. ITO	DATE 2006/10/16			
	ANGULAR ±3 °		MATERIAL NO. SEE TABLE		DOCUMENT NO. SD-502386-003		SHEET NO. 2 OF 2
DRAFT WHERE APPLICABLE MUST REMAIN WITHIN DIMENSIONS		THIS DRAWING CONTAINS INFORMATION THAT IS PROPRIETARY TO MOLEX INCORPORATED AND SHOULD NOT BE USED WITHOUT WRITTEN PERMISSION					