



产品编号 : [5024390400](#)

Product Description : CLIK-Mate Plug Housing, 2.00mm Pitch, Single Row, Positive Lock, 4 Circuits, White

系列号 : 502439

状态 : Active

Product Category : Connector Housings

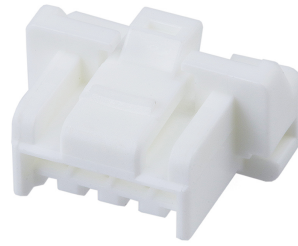

文件和资源

图纸

[图纸 5024390400_sd.pdf](#)

3D 模型和设计文件

[3D模型 5024390400_stp.zip](#)

规格

[应用规格 AS-502439-001-001.pdf](#)

[应用规格 AS-502439-002-001.pdf](#)

[包装规格 5024399200-200.pdf](#)

[产品规格 5024431570-000.pdf](#)

产物环境合规

合规

GADSL/IMDS	Not Relevant
China RoHS	
EU ELV	Not Relevant
Low-Halogen Status	Not Low-Halogen per IEC 61249-2-21
REACH SVHC	Contains TBBA per D(2023)3788-DC (14 Jun 2023)
EU RoHS	Compliant per EU 2015/863

多部分产品合规性声明

- Eu RoHS
- REACH SVHC
- Low-Halogen

多部分行业合规性文件

- IPC 1752A Class C
- IPC 1752A Class D
- Molex Product Compliance Declaration
- IEC-62474
- chemSHERPA (xml)

欧盟 RoHS 合格证书

产品详情

常规

状态	活动
类别	Connector Housings
系列	502439
说明	CLIK-Mate Plug Housing, 2.00mm Pitch, Single Row, Positive Lock, 4 Circuits, White
应用	Signal, Wire-to-Board
个评论	See Product Specification for maximum current rating by circuit size and wire AWG
产品系列	CLIK-Mate Wire-to-Board Connectors
产品名称	CLIK-Mate
UPC	822350915823

机构

UL	E29179
----	--------

电气

每触点最大电流	3.0A
---------	------

物理

断开	否
电路数 (最多)	4
颜色-树脂	白色
性别	Plug
符合灼热丝规范	否
插接极性	是

锁定插接部位	是
材料 - 树脂	PBT
净重	397.000/mg
行数	1
包装形式	Bag
面板安装式	否
间距 - 插配接口	2.00mm
有极性的插配件	是
可堆叠的	否
运行温度范围	-40° to +105° C

可配插/可连接使用的产品

可配插部件

描述	产品编号
2.00mm Pitch CLIK-Mate Vertical Single Row PCB Receptacles	<u>502443</u>
2.00mm Pitch CLIK-Mate Right-Angle Single Row PCB Receptacles	<u>502494</u>

可连接使用部件

描述	产品编号
Pre-Crimped Lead CLIK-Mate 2.00mm Male-to-CLIK-Mate 2.00mm Male, Tin (Sn) Plating, 150.00mm Length, 24 AWG, Black	<u>/content/molex/molex-dot-com/cn/zh/products/product-page.html/797581014.html</u>
Pre-Crimped Lead CLIK-Mate 2.00mm Male-to-CLIK-Mate 2.00mm Male, Tin (Sn) Plating, 300.00mm Length, 24 AWG, Black	<u>/content/molex/molex-dot-com/cn/zh/products/product-page.html/797581015.html</u>
2.00mm Pitch CLIK-Mate Male Crimp Terminals	<u>502438</u>

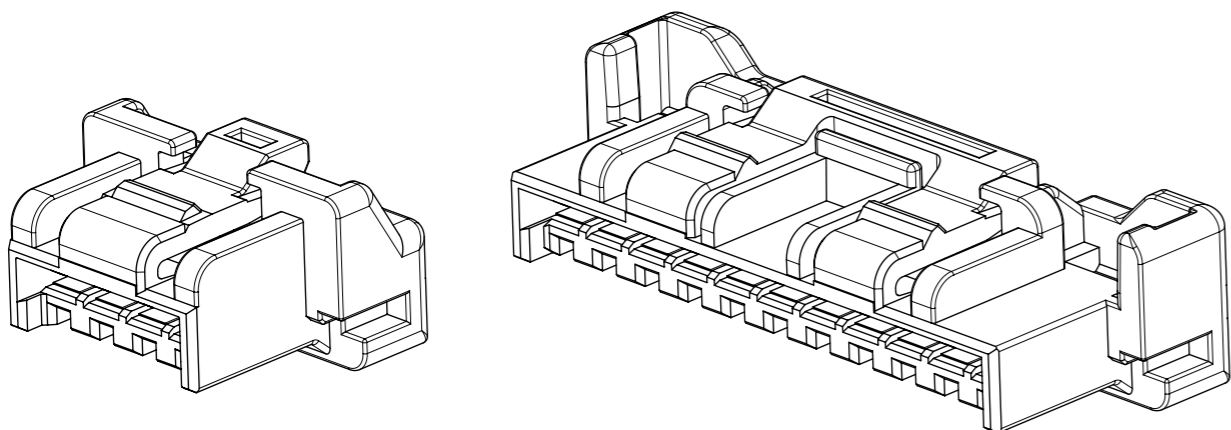
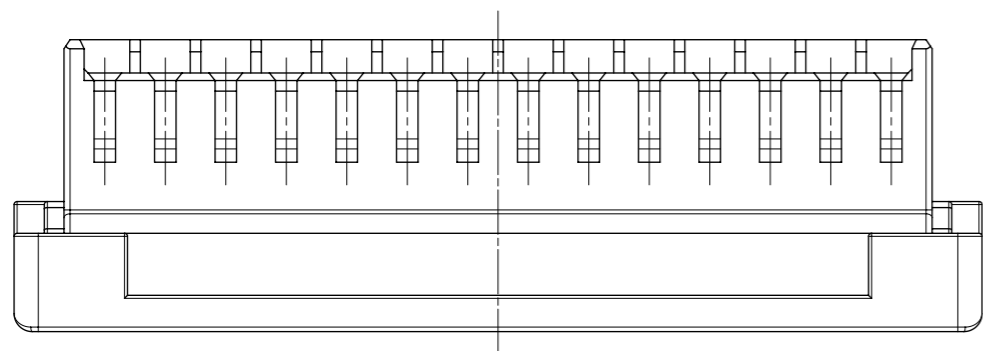
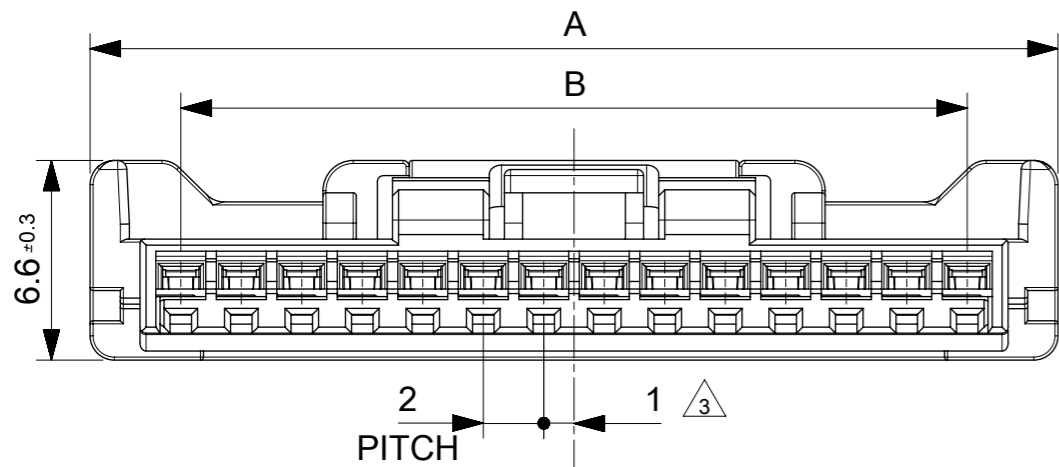
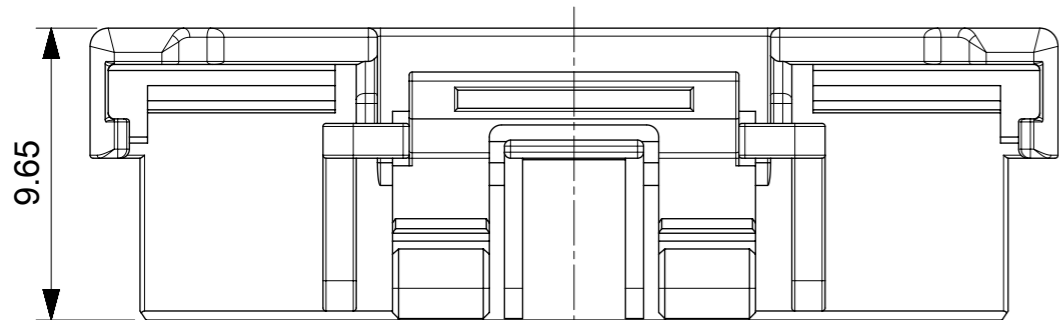

2-4CKT.ロック形状
2-4CKT.LOCK FORM

5-15CKT.ロック形状
5-15CKT.LOCK FORM

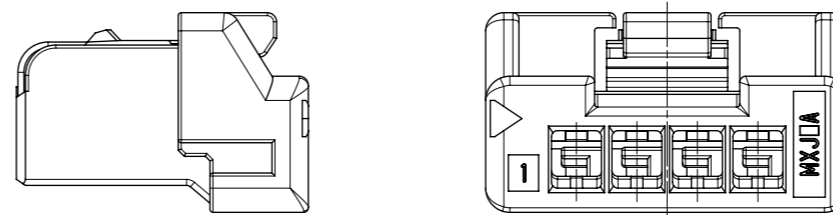

2-4CKT.外觀形状
2-4CKT. APPEARANCE FORM

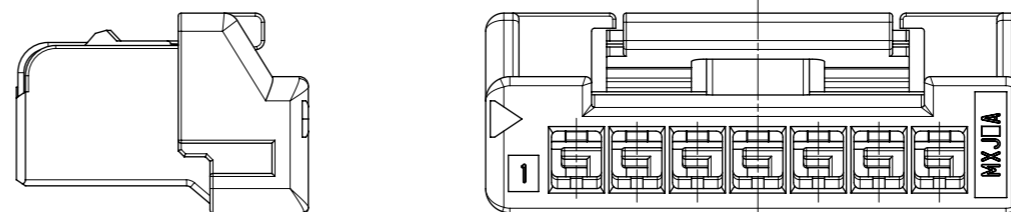

5-7CKT.外觀形状
5-7CKT. APPEARANCE FORM

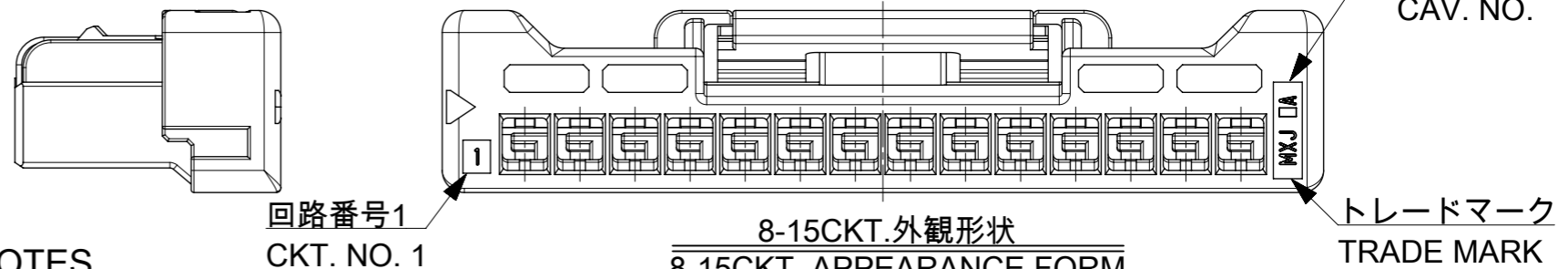

8-15CKT.外觀形状
8-15CKT. APPEARANCE FORM

NOTES

- 適合ターミナル : 502438-0*00
APPLICABLE TARMINAL : 502438-0*00
- 嵌合相手
ST type : 502443-**70(カバーテープ無),502443-**60(カバーテープ有)
RA type : 502494-**70
MATE WITH
ST type : 502443-**70(without cover tape),502443-**60(with cover tape)
RA type : 502494-**70
- 極数/2 = 偶数に適用
APPLY FOR CKT. SIZE /2 = EVEN.
- 本製品のプラスチック部に黒点等が確認される場合や色合いが異なる場合がありますが、製品性能に影響はありません。
THERE IS NO INFLUENCE IN THE PRODUCT PERFORMANCE THOUGH THE BLACK SPOT ETC. MIGHT BE CONIRMED TO THE PLASTIC PART OF THIS PRODUCT AND THE SHADE MIGHT BE DIFFERENT.
- アプリケーション仕様書(コネクタ取扱い説明書) : AS-502439-001(日本語版)/-002(英語版)
APPLICATION SPECIFIONS (CONNECTOR MANNUAL):AS-502439-001(JAPANESE)/-002(ENGLISH))
- 製品仕様書:5024431570PS000
PRODUCT SPECIFICATION : 5024431570PS000
- ELV 及び RoHS 適合品
ELV AND RoHS COMPLIANT

28	34	502439-1500	15
26	32	502439-1400	14
24	30	502439-1300	13
22	28	502439-1200	12
18	24	502439-1000	10
16	22	502439-0900	9
14	20	502439-0800	8
12	18	502439-0700	7
10	16	502439-0600	6
8	14	502439-0500	5
6	12	502439-0400	4
4	10	502439-0300	3
2	8	502439-0200	2
B	A	製品番号 MATERIAL NO.	極数 CKT.NO.

THIS DRAWING CONTAINS INFORMATION THAT IS PROPRIETARY TO MOLEX ELECTRONIC TECHNOLOGIES, LLC AND SHOULD NOT BE USED WITHOUT WRITTEN PERMISSION

REVISED	2017/08/24	GENERAL TOLERANCES (UNLESS SPECIFIED)	DIMENSION UNITS	SCALE
	2017/08/25	ANGULAR TOL ± 3.0 °	mm	4:1
	2017/08/25	4 PLACES ± 0.2	DRWN BY	DATE
		3 PLACES ± 0.2	AISHIKAWA	2016/04/19
EC NO: 121080	DRWN: AISHIKAWA	2 PLACES ± 0.2	CHK'D BY	DATE
		1 PLACE ± 0.2	KOMURAKAMI	2016/04/28
		0 PLACES ± 0.2	APPR BY	DATE
		TKANEKO	2016/04/28	
		DRAFT WHERE APPLICABLE MUST REMAIN WITHIN DIMENSIONS	DRAWING SIZE	THIRD ANGLE PROJECTION
			A3	

molex			
CLIK-MATE 2.0MM PITCH W/B CONN. SINGLE PLUG HSG			
PRODUCT CUSTOMER DRAWING			
SERIES	MATERIAL NUMBER	CUSTOMER	
502439	SEE TABLE	GENERAL	
DOCUMENT NUMBER		DOC TYPE	DOC PART SHEET NUMBER
5024391500		PSD	000 1 OF 1

部品 PART	材質 MATERIAL
ハウジング HOUSING	ポリブチレンテレフタレート UL94V-0 色 : 白 POLYBUTYLENE TEREPHTHALATE UL94V-0 COLOR:WHITE
RELEASE STATUS	P1
RELEASE DATE	25.08.2017 07:01:56