

产品编号 : [5031491000](#)

Product Description : CLIK-Mate Plug Housing, 1.50mm Pitch, Dual Row, Positive Lock, 10 Circuits, Natural

系列号 : 503149

状态 : Active

Product Category : Connector Housings

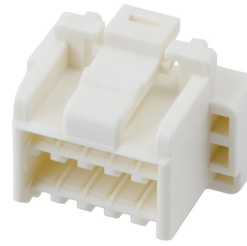

文件和资源

图纸

[图纸 5031491000_sd.pdf](#)

3D 模型和设计文件

[2D 图纸 DXF 5031491000.dxf](#)

[2D 图纸 DXF PDF 5031491000.pdf](#)

[3D模型 5031491000_stp.zip](#)

规格

[应用规格 AS-503149-001-001.pdf](#)

[包装规格 SPK-503149-001-001.pdf](#)

[产品规格 PS-505406-001-001.pdf](#)

[产品规格 5031490000-PS-000.pdf](#)

[产品规格 5031490001-PS-000.pdf](#)

[产品规格 5031491000-PS-000.pdf](#)

[产品规格 5031491001-PS-000.pdf](#)

[产品规格 5031491002-PS-000.pdf](#)

[产品规格 5031490002-PS-000.pdf](#)

[产品规格 5031491003-PS-000.pdf](#)

[产品规格 5031491004-PS-000.pdf](#)

产物环境合规

合规

GADSL/IMDS	Not Relevant
China RoHS	
EU ELV	Not Relevant
Low-Halogen Status	Not Low-Halogen per IEC 61249-2-21
REACH SVHC	Not Contained per D(2023)3788-DC (14 Jun 2023)

EU RoHS	Compliant per EU 2015/863
---------	---------------------------

多部分产品合规性声明

- Eu RoHS
- REACH SVHC
- Low-Halogen

多部分行业合规性文件

- IPC 1752A Class C
- IPC 1752A Class D
- Molex Product Compliance Declaration
- IEC-62474
- chemSHERPA (xml)

欧盟 RoHS 合格证书

产品详情

常规

状态	活动
类别	Connector Housings
系列	503149
说明	CLIK-Mate Plug Housing, 1.50mm Pitch, Dual Row, Positive Lock, 10 Circuits, Natural
应用	Signal, Wire-to-Board
产品系列	CLIK-Mate Wire-to-Board Connectors
产品名称	CLIK-Mate
UPC	800756961668

机构

UL	E29179
----	--------

物理

电路数（最多）	10
颜色-树脂	Natural
性别	Plug
符合灼热丝规范	否
插接极性	无
锁定插接部位	是

材料 - 树脂	PBT
净重	410.000/mg
行数	2
包装形式	Bag
面板安装式	否
间距 - 插配接口	1.50mm
间距 - 终端界面	1.50mm
有极性的插配件	是
可堆叠的	否
运行温度范围	-40° to +105° C

可配插/可连接使用的产品

可配插部件

描述	产品编号
1.50mm Pitch CLIK-Mate Right-Angle Dual Row PCB Receptacles	<u>213228</u>
1.50mm Pitch CLIK-Mate Right-Angle Dual Row PCB Receptacles	<u>503148</u>
1.50mm Pitch CLIK-Mate Vertical Dual Row PCB Receptacles	<u>213227</u>
1.50mm Pitch CLIK-Mate Right-Angle Dual Row PCB Receptacles	<u>503154</u>

可连接使用部件

描述	产品编号
Pre-Crimped Lead CLIK-Mate 1.50mm Male-to-CLIK-Mate 1.50mm Male, Tin (Sn) Plating, 300.00mm Length, 24 AWG, Black	/content/molex/molex-dot-com/cn/zh/products/product-page.html/797581011.html
1.50mm Pitch CLIK-Mate Male Crimp Terminals	<u>502579</u>
1.50mm Pitch CLIK-Mate Male Crimp Terminals	<u>503429</u>
CLIK-Mate 1.50mm Pitch Male Crimp Terminals	<u>213028</u>
CLIK-Mate 1.50mm Pitch Male Crimp Terminals	<u>213029</u>
Pre-Crimped Lead Clik-Mate Male-to-Clik-Mate Male	<u>215710</u>

Pre-Crimped Lead Klik-Mate Male- to-Pigtail	<u>215711</u>
--	---------------

This document was generated on Dec 29, 2023

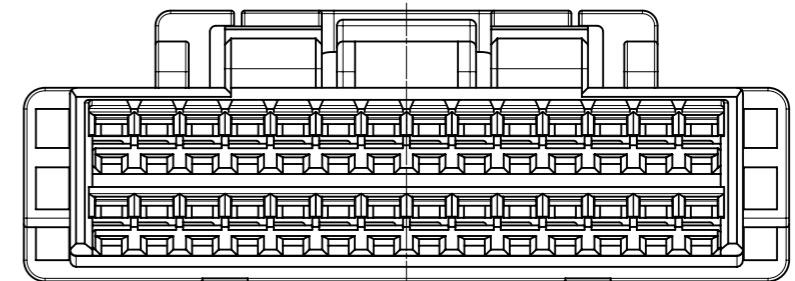
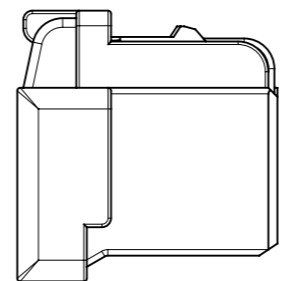
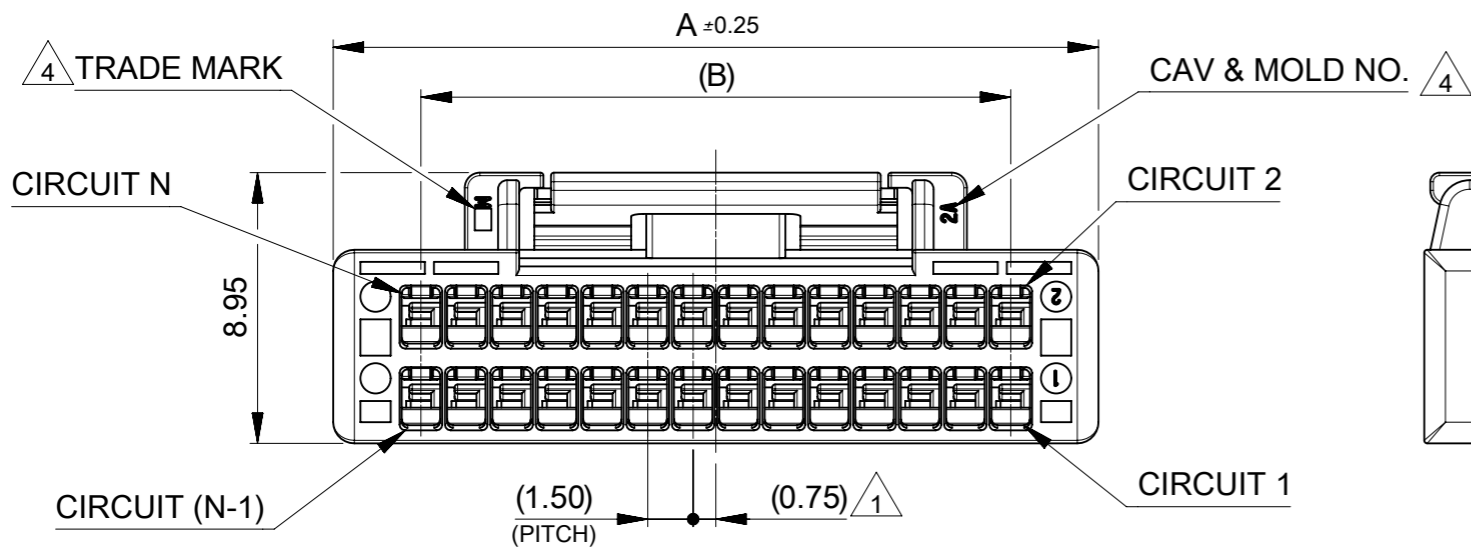
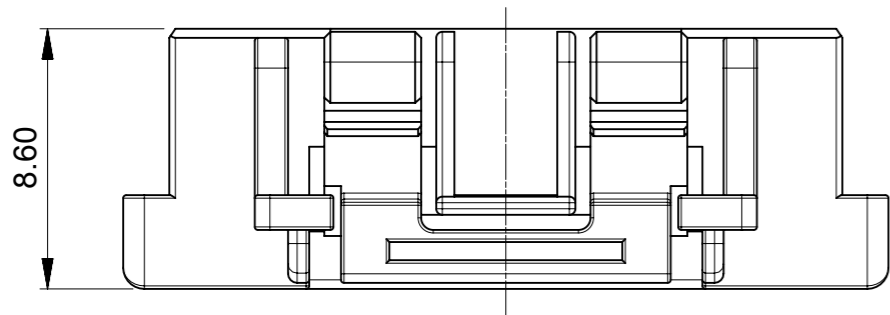

NOTES

- ① 極数/2 = 偶数に適用
APPLY FOR CIRCUIT SIZE / 2 =EVEN
- ② 関連製品・書類はSHEET 2参照のこと
REFER TO SHEET 2 ABOUT RELATED PRODUCTS AND DOCUMENTS.
- ③ オーダー番号(製品番号): SHEET 3の製品一覧を参照のこと
ORDER No. (PRODUCT No.) : REFER TO SHEET 3 FOR PRODUCT LIST.

503149 **0*

シリーズ番号 極数 色
SERIES NO CIRCUIT SIZE COLOR

CIRCUIT NO.	ハウジングカラー HOUSING COLOR
0	ナチュラル NATURAL
1	黒 BLACK
2	赤 RED
4	青 BLUE
6	緑 GREEN

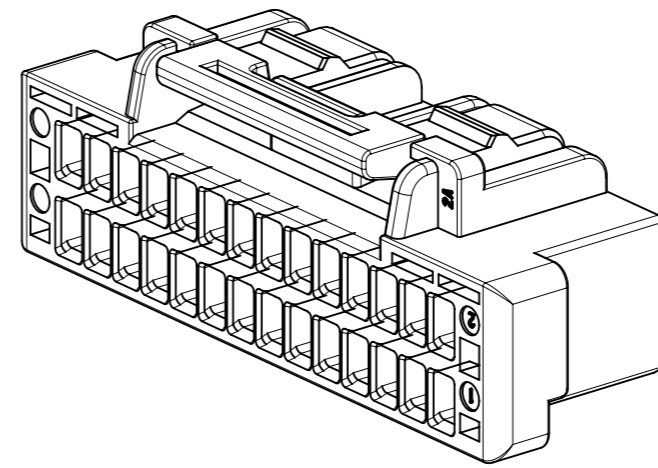

24.0	29.8	34
22.5	28.3	32
21.0	26.8	30
19.5	25.3	28
18.0	23.8	26
16.5	22.3	24
15.0	20.8	22
13.5	19.3	20
12.0	17.8	18
10.5	16.3	16
9.0	14.8	14
7.5	13.3	12
6.0	11.8	10
4.5	10.3	8
B	A	CKT SIZE

④ トレードマーク : Mプラス 2文字の製造工場を示すアルファベットにて表示。
但し、"J"はJAPANを、"L"はMALAYSIAを示す。(例: MXJ, MXL)
金型番号 : アルファベット2文字にて表示。(例: 1A, 12A, 1B, 12B)

部品 PART	材質 MATERIAL
ハウジング HOUSING	ポリエステル(PBT), UL94V-0, 色 : SEE CHART POLYESTER (PBT), UL94V-0, COLOR : SEE CHART

DOCUMENT STATUS	P1	RELEASE DATE	2020/08/19	07:21:49
-----------------	----	--------------	------------	----------

THIS DRAWING CONTAINS INFORMATION THAT IS PROPRIETARY TO MOLEX ELECTRONIC TECHNOLOGIES, LLC AND SHOULD NOT BE USED WITHOUT WRITTEN PERMISSION

DIMENSION UNITS	SCALE	CURRENT REV DESC:	molex		
mm	NTS				
GENERAL TOLERANCES (UNLESS SPECIFIED)			CLIK-MATE 1.5 DUAL PLUG HSG		
ANGULAR TOL	± 3.0 °	EC NO: 643631	PRODUCT CUSTOMER DRAWING		
4 PLACES	± 0.2	DRWN: MIKEDA01 2020/08/19	DOCUMENT NUMBER		
3 PLACES	± 0.2	CHK'D: SAKIYAMA 2020/08/19	DOC TYPE DOC PART REVISION		
2 PLACES	± 0.2	APPR: KOMURAKAMI 2020/08/19	5031490000-SD PSD 000 B		
1 PLACE	± 0.2	INITIAL REVISION:	MATERIAL NUMBER CUSTOMER SHEET NUMBER		
0 PLACES	± 0.2	DRWN: MIKEDA01 2019/06/12	503149 GENERAL 1 OF 3		
DRAFT WHERE APPLICABLE MUST REMAIN WITHIN DIMENSIONS		THIRD ANGLE PROJECTION	DRAWING	SERIES	
			A3-SIZE	503149	

△ 2 適用製品及び各種仕様書
 APPLICABLE PRODUCTS AND VARIOUS SPECIFICATIONS

梱包仕様書 PACKAGING SPECIFICATION	PART NUMBER 503149 - ****	DOCUMENT NUMBER SPK-503149-001
----------------------------------	------------------------------	-----------------------------------

	PLATING TYPE	PART NUMBER	WIRE SIZE(AWG)
適用端子 APPLICABLE TERMINAL	TIN	502579 0000	#24 - #28
		503429 0000	#26 - #30
	GOLD	213028 **00	#24 - #26
		213029 **00	#26 - #28

適用レセプタクルコネクタ APPLICABLE REC. CONNECTOR	SMT			
	TIN PLATING		GOLD PLATING	
	VERTICAL	RIGHT ANGLE	VERTICAL	RIGHT ANGLE
シリーズ番号 SERIES No.	503154	503148	213227	213228
製品仕様書 PRODUCT SPECIFICATION	5031490000-PS/PS/000	5031490001-PS/PS/000	5031490002-PS/PS/000	
アプリケーション仕様書 APPLICATION SPECIFICATION	AS-503149-001(JAPANESE) / 5031490000 PS 000 (ENGLISH)			

THIS DRAWING CONTAINS INFORMATION THAT IS PROPRIETARY TO MOLEX ELECTRONIC TECHNOLOGIES, LLC AND SHOULD NOT BE USED WITHOUT WRITTEN PERMISSION											
DIMENSION UNITS	SCALE	CURRENT REV DESC:				molex					
mm	NTS					CLIK-MATE 1.5 DUAL PLUG HSG					
GENERAL TOLERANCES (UNLESS SPECIFIED)						PRODUCT CUSTOMER DRAWING					
ANGULAR TOL ± 3.0 °											
4 PLACES ± 0.2	3 PLACES ± 0.2	2 PLACES ± 0.2	1 PLACE ± 0.2	0 PLACES ± 0.2	EC NO: 643631	DRWN: MIKEDA01	2020/08/19	CHK'D: SAKIYAMA	2020/08/19	APPR: KOMURAKAMI	2020/08/19
DRAFT WHERE APPLICABLE MUST REMAIN WITHIN DIMENSIONS		THIRD ANGLE PROJECTION		DRAWING	SERIES	MATERIAL NUMBER	CUSTOMER	DOCUMENT NUMBER	DOC TYPE	DOC PART	REVISION
				A3-SIZE	503149	5031490000-SD	GENERAL	5031490000-SD	PSD	000	B
											SHEET NUMBER 2 OF 3

極数別形状
PRODUCT SHAPE AT EACH CKT

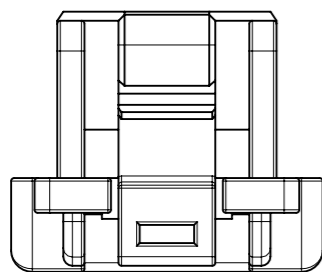

8極形状(1口ック)
FIGURE OF 8 CIRCUITS (1 LOCK)

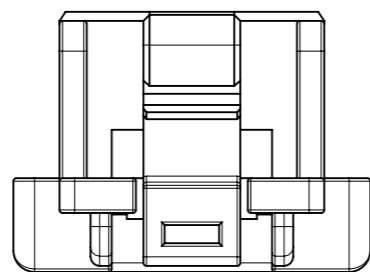

10極形状(1口ック)
FIGURE OF 10 CIRCUITS (1 LOCK)

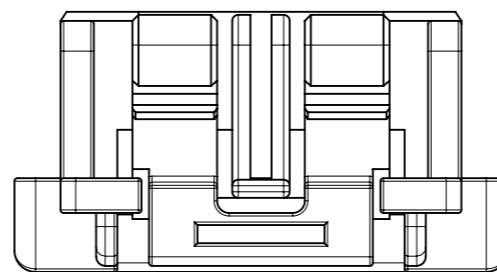

12-18極形状(2口ック)
FIGURE OF 12-18 CIRCUITS (2 LOCKS)

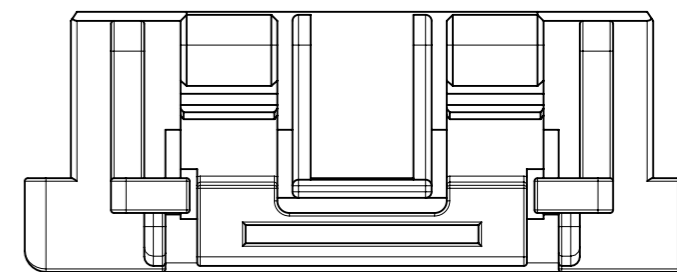

20-34極形状(2口ック)
FIGURE OF 20-34 CIRCUITS (2 LOCKS)

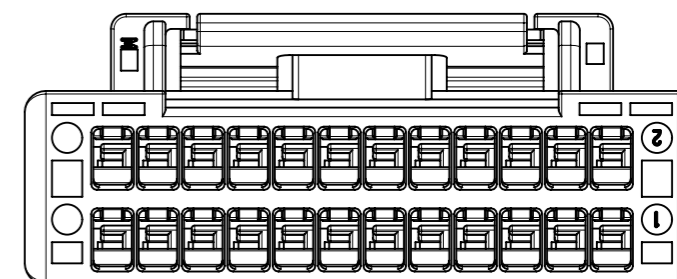
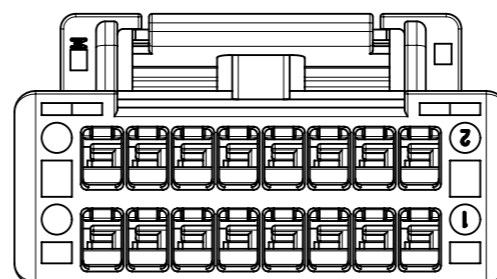
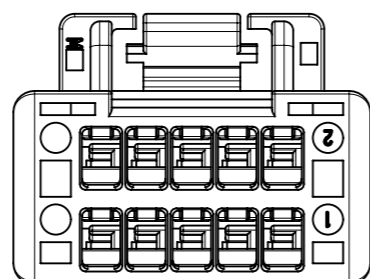
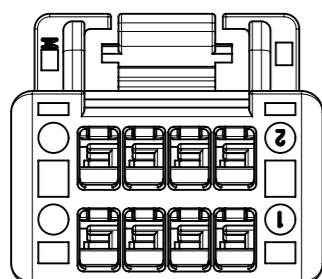

3 製品一覧
PRODUCTS LIST

緑 GREEN	青 BLUE	赤 RED	黒 BLACK	ナチュラル NATURAL	HOUSING COLOR
-	-	-	503149 3401	503149 3400	34
503149 3206	503149 3204	503149 3202	503149 3201	503149 3200	32
503149 3006	503149 3004	503149 3002	503149 3001	503149 3000	30
503149 2806	503149 2804	503149 2802	503149 2801	503149 2800	28
503149 2606	503149 2604	503149 2602	503149 2601	503149 2600	26
503149 2406	503149 2404	503149 2402	503149 2401	503149 2400	24
503149 2206	503149 2204	503149 2202	503149 2201	503149 2200	22
503149 2006	503149 2004	503149 2002	503149 2001	503149 2000	20
503149 1806	503149 1804	503149 1802	503149 1801	503149 1800	18
503149 1606	503149 1604	503149 1602	503149 1601	503149 1600	16
503149 1406	503149 1404	503149 1402	503149 1401	503149 1400	14
503149 1206	503149 1204	503149 1202	503149 1201	503149 1200	12
503149 1006	503149 1004	503149 1002	503149 1001	503149 1000	10
503149 0806	503149 0804	503149 0802	503149 0801	503149 0800	8
オーダー番号 ORDER No					極数 CIRCUIT No

THIS DRAWING CONTAINS INFORMATION THAT IS PROPRIETARY TO MOLEX ELECTRONIC TECHNOLOGIES, LLC AND SHOULD NOT BE USED WITHOUT WRITTEN PERMISSION		CURRENT REV DESC:		molex	
DIMENSION UNITS	SCALE				
mm	NTS			CLIK-MATE 1.5 DUAL PLUG HSG	
GENERAL TOLERANCES (UNLESS SPECIFIED)				PRODUCT CUSTOMER DRAWING	
ANGULAR TOL	± 3.0 °			DOCUMENT NUMBER	
4 PLACES	± 0.2	EC NO: 643631		5031490000-SD	
3 PLACES	± 0.2	DRWN: MIKEDA01 2020/08/19		DOC TYPE DOC PART REVISION	
2 PLACES	± 0.2	CHK'D: SAKIYAMA 2020/08/19		PSD 000 B	
1 PLACE	± 0.2	APPR: KOMURAKAMI 2020/08/19			
0 PLACES	± 0.2	INITIAL REVISION:			
DRAFT WHERE APPLICABLE MUST REMAIN WITHIN DIMENSIONS		DRWN: MIKEDA01 2019/06/12		MATERIAL NUMBER	
		APPR: KOMURAKAMI 2019/11/20		CUSTOMER	
		THIRD ANGLE PROJECTION		GENERAL	
		DRAWING		SHEET NUMBER	
		A3-SIZE		3 OF 3	
		SERIES			
		503149			