



产品编号 : 5037650098

Product Description : 1.00mm Pitch, Pico-Lock Female Crimp Terminal, Gold (Au) Plating, 28-30 AWG, Reel

系列号 : 503765

状态 : Active

Product Category : Crimp Terminals

文件和资源

图纸

图纸 5037650098_sd.pdf

3D 模型和设计文件

3D模型 5037650098_stp.zip

规格

应用规格 AS-503764-001-001.pdf

包装规格 SPK-503765-001-001.pdf

产品规格 5037640000-PS-000.pdf

产品规格 5037641001-PS-000.pdf

产品规格 PS-503764-001-001.pdf

模具规格

应用模具规格 5780823700ATP-E-000.pdf

应用模具规格 5780823700ATS-000.pdf

应用模具规格 5780823700ATP-J-000.pdf

应用模具规格 5780823700ATS-J-000.pdf

压接规格 CS-503765-001-001.pdf

产物环境合规

合规

GADSL/IMDS	Not Relevant
China RoHS	
EU ELV	Compliant per 2000/53/EC
Low-Halogen Status	Low-Halogen per IEC 61249-2-21
REACH SVHC	Not Contained per D(2023)8585-DC (23 Jan 2024)
EU RoHS	Compliant per EU 2015/863

多部分产品合规性声明

- Eu RoHS
- REACH SVHC
- Low-Halogen
- IPC 1752A Class C
- IPC 1752A Class D
- Molex Product Compliance Declaration
- IEC-62474
- chemSHERPA (xml)

欧盟 RoHS 合格证书

产品详情

常规

状态	活动
类别	Crimp Terminals
系列	503765
说明	1.00mm Pitch, Pico-Lock Female Crimp Terminal, Gold (Au) Plating, 28-30 AWG, Reel
应用	Signal, Wire-to-Board
产品系列	Pico-Lock Connector System
产品名称	Pico-Lock
UPC	887191353821

电气

每触点最大电流	1.5A
电压 - 最大	150V

物理

耐用性(插拔次数) - 最多次数	30
性别	女
材料 - 金属	Copper Alloy
材料 - 接合部位电镀	金牌
材料 - 终端电镀	Tin
净重	7.040/mg
包装形式	Reel
终端界面类型	Crimp or Compression

导线绝缘直径	0.5 - 0.7mm
线径规格 (AWG)	28, 30
线缆尺寸mm ²	不适用

可连接使用部件

描述	产品编号
1.00mm Pitch, Pico-Lock Single Row Receptacle Housings	<u>503764</u>

施工工具

全局

描述	产品编号
Hand Crimp Tool for 1.00mm Pitch Pico-Lock Crimp Terminal, AWG 28-30	<u>638275700</u>
FineAdjust Applicator for Pico-Lock 1.00mm Wire to Board Crimp Terminal, 28-30 AWG	<u>639033400</u>

施工工具

日本

描述	产品编号
S-1 Applicator for Pico-Lock Receptacle Terminal, 28-30 AWG	<u>5780823700</u>

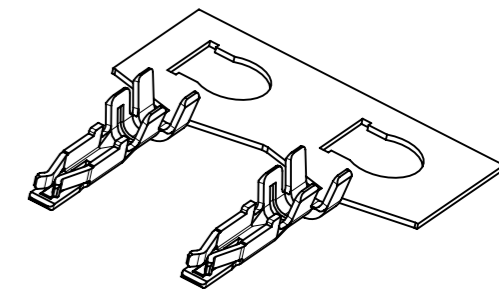
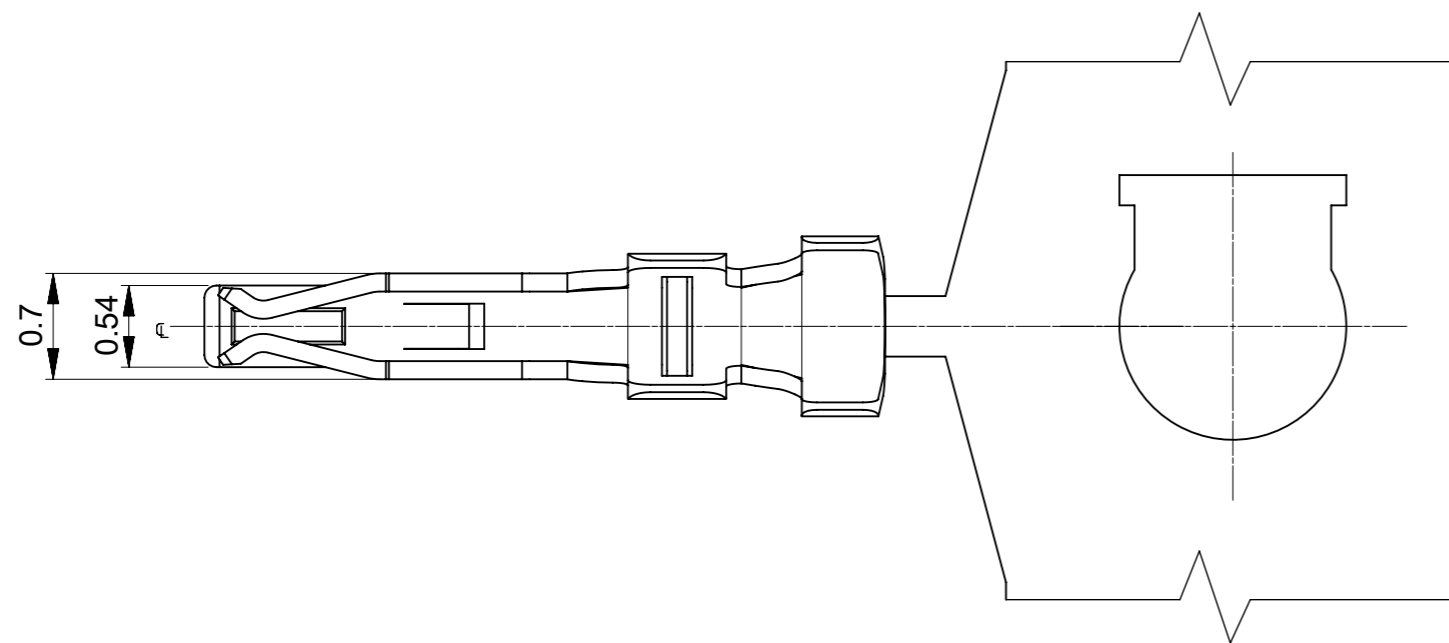

NOTES

1. 材質及びめっき仕様
MATERIAL AND FINISH

部品 PART	材質 MATERIAL
ターミナル TERMINAL	銅合金 COPPER ALLOY
	コンタクト部 : 金めっき 0.1 micro-meters MIN CONTACT AREA: GOLD PLATING 0.1 micro-meters MIN
	バレル部 : 無光沢錫めっき 1.0micro-meter MIN BARREL AREA : MATTE TIN PLATING 1.0micro-meter MIN
	ニッケルめっき(下地) 1.0 micro-meter MIN NICKEL PLATING (UNDER PLATING) 1.0 micro-meter MIN

2. 適用製品及び各種仕様書はSHEET 2を参照のこと
REFER TO SHEET 2 ABOUT APPLICABLE PRODUCTS
AND VARIOUS SPECIFICATIONS

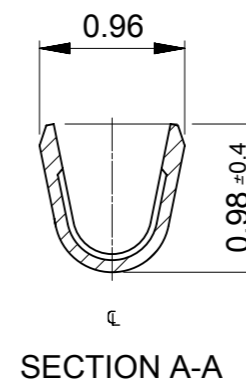
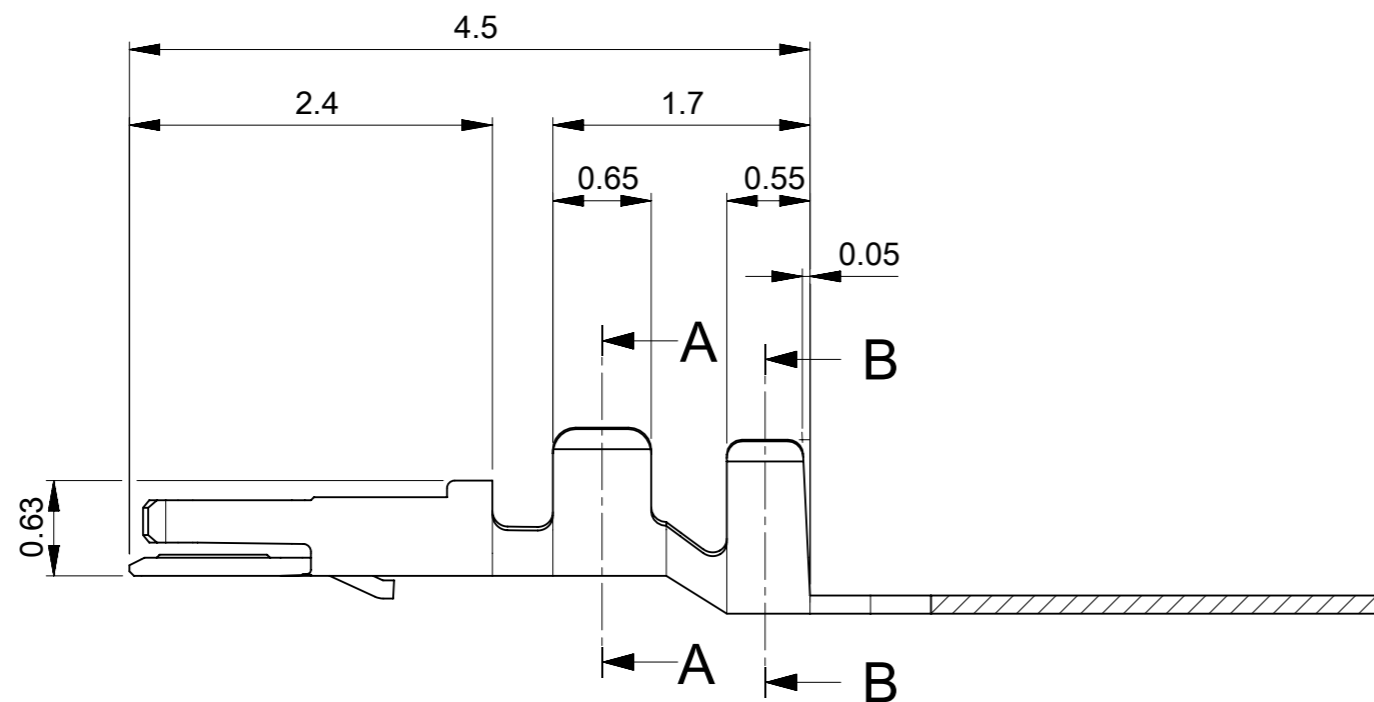
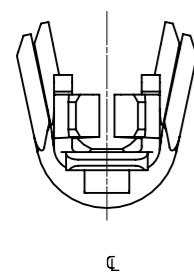

SECTION A-A

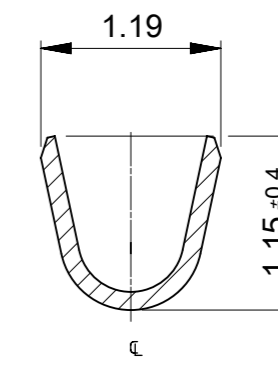

SECTION B-B

∅0.5-0.7	AWG #28-30	5037650098	CHAIN
INS RANGE	WIRE RANGE	ORDER NO	FORM

THIS DRAWING CONTAINS INFORMATION THAT IS PROPRIETARY TO MOLEX ELECTRONIC TECHNOLOGIES, LLC AND SHOULD NOT BE USED WITHOUT WRITTEN PERMISSION					
DIMENSION UNITS	SCALE	CURRENT REV DESC: REDRAWN AND REVISED			
mm	NTS				
GENERAL TOLERANCES (UNLESS SPECIFIED)				PICO-LOCK1.0 REC CRIMP TERM AWG#28-30	
ANGULAR TOL	± 3.0 °			PRODUCT CUSTOMER DRAWING	
4 PLACES	± 0.2			DOCUMENT NUMBER	
3 PLACES	± 0.2			DOC TYPE DOC PART REVISION	
2 PLACES	± 0.2	5037650000-SD			
1 PLACE	± 0.2	PSD 000 A			
0 PLACES	± 0.2	SEE CHART			
DRAFT WHERE APPLICABLE MUST REMAIN WITHIN DIMENSIONS	THIRD ANGLE PROJECTION	DRAWING	SHEET NUMBER		
		A3-SIZE	1 OF 2		

△ 適用製品及び各種仕様書
 APPLICABLE PRODUCTS AND VARIOUS SPECIFICATIONS

梱包仕様書 PACKAGING SPECIFICATION	PART NUMBER 5037650098	DOCUMENT NUMBER SPK-503765-001
----------------------------------	---------------------------	-----------------------------------

適用ハウジング APPLICABLE HOUSING	SINGLE TYPE
----- シリーズ番号 SERIES No	503764

適合嵌合相手 MATE WITH	SMT
	GOLD PLATING
	RIGHT ANGLE
----- シリーズ番号 SERIES No	503763
製品仕様書 PRODUCT SPECIFICATION	PS-503764-001
アプリケーション仕様書 APPLICATION SPECIFICATION	AS-503764-001

THIS DRAWING CONTAINS INFORMATION THAT IS PROPRIETARY TO MOLEX ELECTRONIC TECHNOLOGIES, LLC AND SHOULD NOT BE USED WITHOUT WRITTEN PERMISSION										
DIMENSION UNITS	SCALE	CURRENT REV DESC: REDRAWN AND REVISED					molex			
mm	NTS						PICO-LOCK1.0 REC CRIMP TERM AWG#28-30			
GENERAL TOLERANCES (UNLESS SPECIFIED)		EC NO: 640538 DRWN: QHE31 2018/03/14 CHK'D: SAKIYAMA 2020/07/06 APPR: KOMURAKAMI 2020/07/07 INITIAL REVISION: DRWN: QHE31 2018/03/14 APPR: KOMURAKAMI 2020/07/07					PRODUCT CUSTOMER DRAWING			
ANGULAR TOL ± 3.0 °							DOCUMENT NUMBER	DOC TYPE	DOC PART	REVISION
4 PLACES ± 0.2							5037650000-SD	PSD	000	A
3 PLACES ± 0.2										
2 PLACES ± 0.2										
1 PLACE ± 0.2										
0 PLACES ± 0.2										
DRAFT WHERE APPLICABLE MUST REMAIN WITHIN DIMENSIONS	THIRD ANGLE PROJECTION	DRAWING	SERIES	MATERIAL NUMBER	CUSTOMER	SHEET NUMBER				
		A3-SIZE	503765			2 OF 2				