



产品编号 : 5051521400

系列号 : 505152

Product Category : Connector Accessories

Product Description : DuraClik Wire-to-Board 2-Way Terminal Position Assurance (TPA) Retainer, 14 Circuits

状态 : Active

文件和资源

图纸

图纸 5051521400_sd.pdf

3D 模型和设计文件

3D模型 5051521400_stp.zip

规格

应用规格 AS-505151-002-001.pdf

应用规格 AS-505151-001-001.pdf

包装规格 SPK-505152-001-001.pdf

产品规格 5051510002-000.pdf

产品规格 PS-505151-001-001.pdf

产物环境合规

合规

GADSL/IMDS	Duty-To-Declare
China RoHS	
EU ELV	Compliant per 2000/53/EC
Low-Halogen Status	Not Low-Halogen per IEC 61249-2-21
REACH SVHC	Not Contained per D(2023)8585-DC (23 Jan 2024)
EU RoHS	Compliant per EU 2015/863

多部分产品合规性声明

- Eu RoHS
- REACH SVHC
- Low-Halogen

- IPC 1752A Class C
- IPC 1752A Class D

- Molex Product Compliance Declaration

- IEC-62474

- chemSHERPA (xml)

欧盟 RoHS 合格证书

产品详情

常规

状态	活动
类别	Connector Accessories
系列	505152
说明	DuraClik Wire-to-Board 2-Way Terminal Position Assurance (TPA) Retainer, 14 Circuits
应用	汽车
元件类型	Terminal Position Assurance
产品系列	DuraClik Connector System
产品名称	DuraClik
UPC	887191735269

电气

每触点最大电流	3.0A
---------	------

物理

回路数 (已载入)	14
电路数 (最多)	14
锁定插接部位	是
材料 - 树脂	PBT
净重	165.100/mg
行数	1
包装形式	Bag
有极性的插配件	是
运行温度范围	-40° to +125° C
终端界面类型	Crimp or Compression

可连接使用部件

描述	产品编号
DuraClik TPA Single Row Receptacle Housings	<u>505151</u>
DuraClik TPA Female Crimp Terminals	<u>505153</u>

This document was generated on Jun 30, 2024

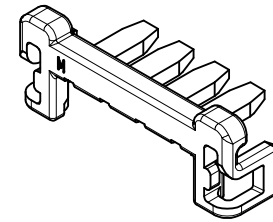
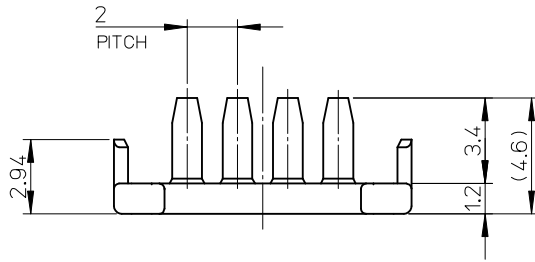

NOTES

1. 材料:PBT (ガラス入り)
PBT (G.F.)
2. 適合ハウジング:505151シリーズ
APPLICABLE HOUSING: 505151 SERIES
3. 適合ターミナル:505153シリーズ
APPLICABLE TERMINAL: 505153 SERIES
4. ELV及びRoHS適合
ELV AND RoHS COMPLIANT

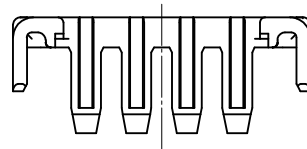
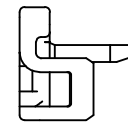
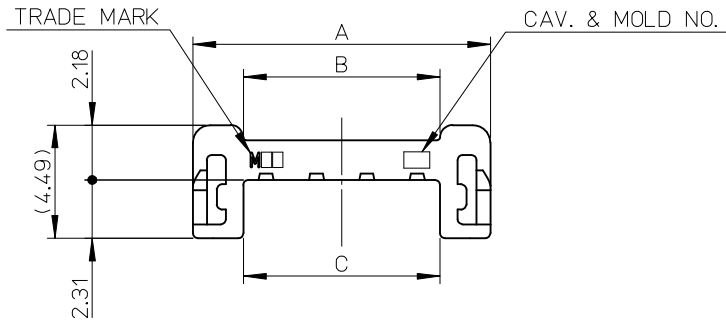

29.8	10.4	33.8	5051521500	15
27.8	10.4	31.8	5051521400	14
25.8	10.4	29.8	5051521300	13
23.8	10.4	27.8	5051521200	12
21.8	10.4	25.8	5051521100	11
19.8	10.4	23.8	5051521000	10
17.8	10.4	21.8	5051520900	9
15.8	10.4	19.8	5051520800	8
13.8	13.8	17.8	5051520700	7
11.8	11.8	15.8	5051520600	6
9.8	9.8	13.8	5051520500	5
7.8	7.8	11.8	5051520400	4
5.8	5.8	9.8	5051520300	3
3.8	3.8	7.8	5051520200	2
C	B	A	MATERIAL NO.	CKT NO.

RELEASED EC NO.: J2015-0035 DRWN:MIKEDA01 2014/07/08 CHKD:KASAKAWA 2014/07/11 APPR:NUKITA 2014/07/15	GENERAL TOLERANCES (UNLESS SPECIFIED)		DIMENSION STYLE MM ONLY		SCALE 5:1	DESIGN UNITS METRIC	THIRD ANGLE PROJECTION	
	10 UNDER	±0.2	DRAWN BY MIKEDA01	DATE 2014/03/03	TITLE 2.0MM PITCH W/B CONN. RETAINER			
	10 OVER 30 UNDER	±0.25	CHECKED BY KASAKAWA	DATE 2014/03/04				
	30 OVER	±0.3	APPROVED BY NUKITA	DATE 2014/03/28	molex DOCUMENT NO. SD-505152-001 SHEET NO. 1 OF 1			
	ANGULAR ±3 °		MATERIAL NO. SEE CHART					
DRAFT WHERE APPLICABLE MUST REMAIN WITHIN DIMENSIONS		SIZE A3		THIS DRAWING CONTAINS INFORMATION THAT IS PROPRIETARY TO MOLEX INCORPORATED AND SHOULD NOT BE USED WITHOUT WRITTEN PERMISSION				