

产品编号 : [511101450](#)

Product Description : 2.00mm Pitch, Milli-Grid Receptacle Housing, 14 Circuits, without Center Polarization Key, without Locking Ramp, Lead-Free

系列号 : 51110

状态 : Active

Product Category : Connector Housings



文件和资源

图纸

[图纸 511101450_sd.pdf](#)

[包装设计图 PK-51110-300-001.pdf](#)

3D 模型和设计文件

[3D模型 511101450_stp.zip](#)

规格

[应用规格 503940001-AS-000.pdf](#)

[产品规格 PS-51110-001-001.pdf](#)

产物环境合规

合规

GADSL/IMDS	Not Relevant
China RoHS	
EU ELV	Not Relevant
Low-Halogen Status	Not Low-Halogen per IEC 61249-2-21
REACH SVHC	Not Contained per per D(2022)9120-DC (17 Jan 2023)
EU RoHS	Compliant per EU 2015/863

[多部分产品合规性声明](#)

- Eu RoHS
- REACH SVHC
- Low-Halogen

[多部分行业合规性文件](#)

- IPC 1752A Class C
- IPC 1752A Class D
- Molex Product Compliance Declaration
- IEC-62474
- chemSHERPA (xml)

欧盟 RoHS 合格证书

产品详情

常规

状态	活动
类别	Connector Housings
系列	51110
说明	2.00mm Pitch, Milli-Grid Receptacle Housing, 14 Circuits, without Center Polarization Key, without Locking Ramp, Lead-Free
应用	Signal, Wire-to-Board
个评论	Applicable Wire Ranges: 24-30 AWG (series 50394 terminal) and 22-28 AWG (series 87396 terminal)
产品系列	Milli-Grid Connector System
产品名称	Milli-Grid
UPC	800753574212

机构

CSA	LR19980
UL	E29179

物理

电路数 (最多)	14
颜色-树脂	黑色
阻燃性	94V-0
性别	Receptacle
符合灼热丝规范	否
插接极性	无
锁定插接部位	是
材料 - 树脂	Polyester

净重	0.295/g
行数	2
包装形式	Bag
面板安装式	否
间距 - 插配接口	2.00mm
间距 - 终端界面	2.00mm
有极性的插配件	是
可堆叠的	否
运行温度范围	-40° to +105° C

可配插/可连接使用的产品

可配插部件

描述	产品编号
Milli-Grid Vertical Through Hole Headers	<u>87758</u>
Milli-Grid Vertical Surface Mount Headers	<u>87759</u>
Milli-Grid Right-Angle Through Hole Headers	<u>87760</u>
Milli-Grid Vertical, Dual Row, Through Hole Headers	<u>87831</u>
Milli-Grid Vertical, Dual Row, Surface Mount Headers	<u>87832</u>
Milli-Grid BMI Vertical, Dual Row, Through Hole Headers	<u>151013</u>
Milli-Grid Vertical, Dual Row, Through Hole Headers	<u>151117</u>
Milli-Grid Vertical, Dual Row, Surface Mount Headers	<u>151118</u>
Milli-Grid Right-Angle, Dual Row, Through Hole Headers	<u>151119</u>
Milli-Grid Right-Angle, Dual Row, Surface Mount Headers	<u>151120</u>

可连接使用部件

描述	产品编号
Pre-Crimped Lead Milli-Grid Female-to-Milli-Grid Female, Gold (Au) Plating, 150.00mm Length, 24 AWG, Black	<u>/content/molex/molex-dot-com/cn/zh/products/product-page.html/797581095.html</u>

Pre-Crimped Lead Milli-Grid Female-to-Milli-Grid Female, Gold (Au) Plating, 300.00mm Length, 24 AWG, Black	/content/molex/molex-dot-com/cn/zh/products/product-page.html/797581096.html
Milli-Grid Female Crimp Terminals	<u>50394</u>
Milli-Grid Female Crimp Terminals	<u>87396</u>

施工工具

全局

描述	产品编号
Extractor Tool for Milli-Grid 2.0 Housings	<u>0638242800</u>

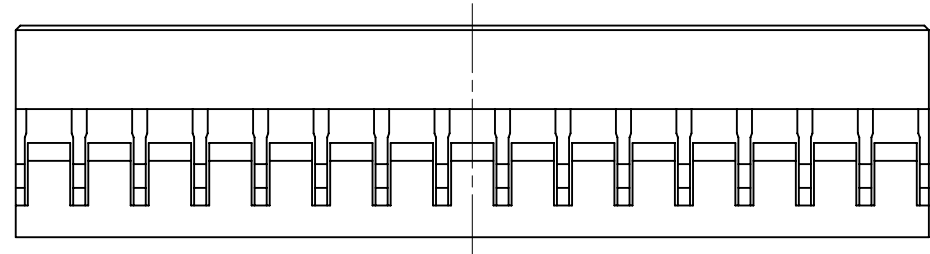
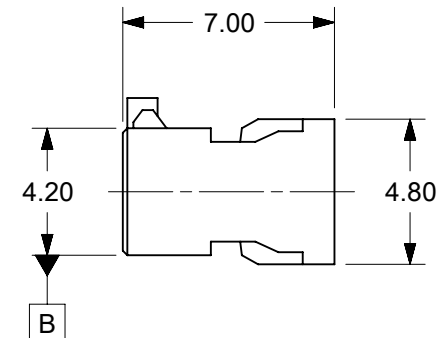
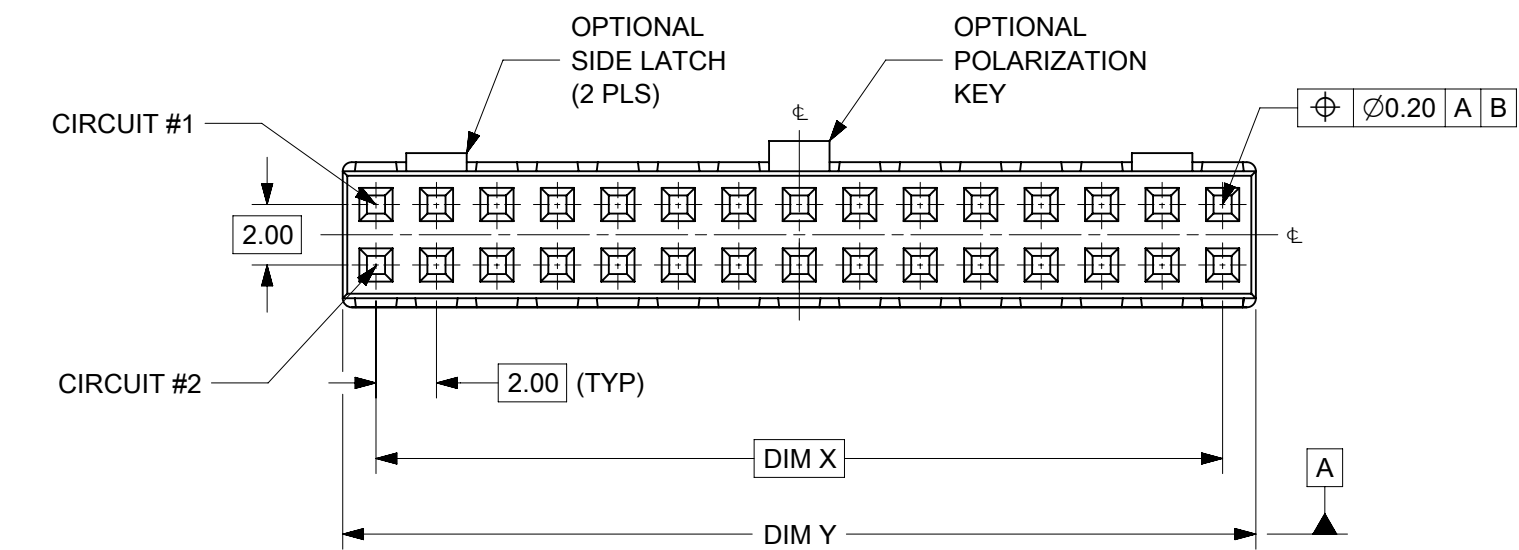
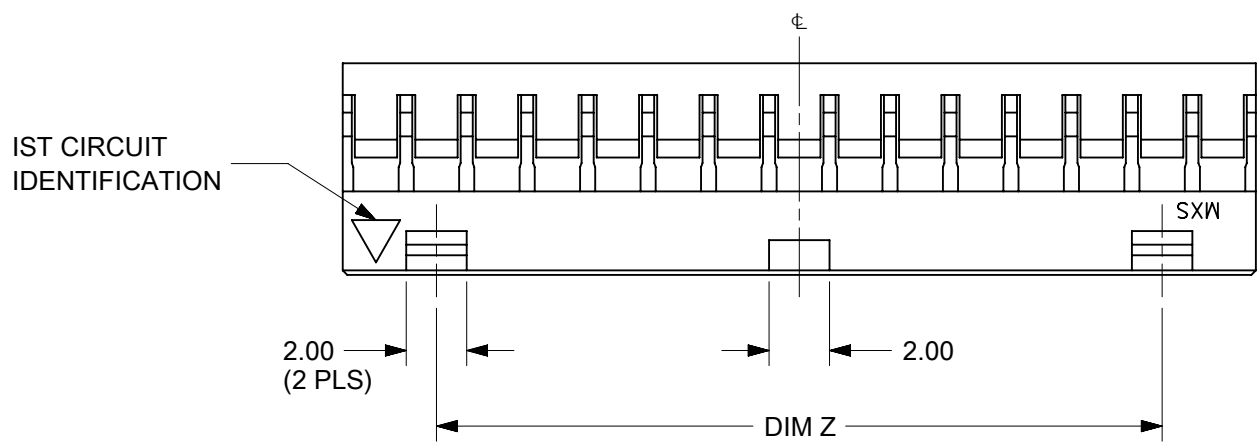

- NOTES:
1. MATERIAL: GLASS-FILLED POLYESTER UL RATED 94V-0
COLOR: BLACK
 2. PART TO BE USED WITH CRIMP TERMINAL
PART NUMBER 50394-8*** AND 87396-****
 3. APPLICABLE WIRE RANGE:
FOR 50394 SERIES, AWG #24 - #30,
FOR 87396 SERIES, AWG #22 - #28.
 4. WIRE INSULATION RANGE: DIAMETER 1.40MM MAXIMUM.
 5. 30 CKT SHOWN FOR ILLUSTRATION ONLY.

FUNCTIONAL SYMBOLS	THIS DRAWING CONTAINS INFORMATION THAT IS PROPRIETARY TO MOLEX ELECTRONIC TECHNOLOGIES, LLC AND SHOULD NOT BE USED WITHOUT WRITTEN PERMISSION		CURRENT REV DESC: RE-MASTERED IN NX/ECTR								
	FUNCTIONAL SYMBOLS	DIMENSION UNITS						SCALE	EC NO: 672815 DRWN: ABABUPS 2021/04/27 CHK'D: MRAMAKRISHNA 2021/08/06 APPR: MRAMAKRISHNA 2021/08/06 INITIAL REVISION: DRWN: SKTOH 1993/10/26 APPR: LBLEE 2014/07/22		
	GENERAL TOLERANCES (UNLESS SPECIFIED)	mm NTS									
	ANGULAR TOL	± 3.0°									
DIVISIONAL SYMBOLS	4 PLACES	±	PRODUCT CUSTOMER DRAWING DOCUMENT NUMBER SD-51110-XX5X DOC TYPE PSD DOC PART 001 REVISION B10								
3 PLACES	±										
2 PLACES	± 0.2										
1 PLACE	±										
0 PLACES	±	DRAFT WHERE APPLICABLE MUST REMAIN WITHIN DIMENSIONS			THIRD ANGLE PROJECTION 	DRAWING B-SIZE	SERIES 51110	MATERIAL NUMBER SEE TABLE	CUSTOMER GENERAL MARKET	SHEET NUMBER 1 OF 2	

WITHOUT CENTER POLARIZATION KEY & SIDE LATCHES

PART NUMBER	CKT SIZE	DIM X	DIM Y
51110-0450	4	2.00	4.20
51110-0650	6	4.00	6.20
51110-0850	8	6.00	8.20
51110-1050	10	8.00	10.20
51110-1250	12	10.00	12.20
51110-1450	14	12.00	14.20
51110-1650	16	14.00	16.20
51110-1850	18	16.00	18.20
51110-2050	20	18.00	20.20
51110-2250	22	20.00	22.20
51110-2450	24	22.00	24.20
51110-2650	26	24.00	26.20
51110-2850	28	26.00	28.20
51110-3050	30	28.00	30.20
51110-3250	32	30.00	32.20
51110-3450	34	32.00	34.20

WITH CENTER POLARIZATION KEY & SIDE LATCHES

PART NUMBER	CKT SIZE	DIM X	DIM Y	DIM Z
51110-1451	14	12.00	14.20	8.00
51110-1651	16	14.00	16.20	10.00
51110-1851	18	16.00	18.20	12.00
51110-2051	20	18.00	20.20	14.00
51110-2251	22	20.00	22.20	16.00
51110-2451	24	22.00	24.20	18.00
51110-2651	26	24.00	26.20	20.00
51110-2851	28	26.00	28.20	22.00
51110-3051	30	28.00	30.20	24.00
51110-3251	32	30.00	32.20	26.00
51110-3451	34	32.00	34.20	28.00

WITH CENTER POLARIZATION KEY

PART NUMBER	CKT SIZE	DIM X	DIM Y
51110-0452	4	2.00	4.20
51110-0652	6	4.00	6.20
51110-0851	8	6.00	8.20
51110-1051	10	8.00	10.20
51110-1251	12	10.00	12.20
51110-1452	14	12.00	14.20
51110-1652	16	14.00	16.20
51110-1852	18	16.00	18.20
51110-2052	20	18.00	20.20
51110-2252	22	20.00	22.20

PART NUMBER LEGEND:

51110 - ** 5 *

CIRCUIT SIZE

0 - WITHOUT CENTER POLARIZATION KEY AND SIDE LATCH.

1 - WITH CENTER POLARIZATION KEY AND SIDE LATCH.
(14 TO 34 CIRCUITS ONLY)
WITH CENTER POLARIZATION KEY ONLY.
(8 TO 12 CIRCUITS ONLY)

2 - WITH CENTER POLARIZATION KEY ONLY.
(4 TO 6 CIRCUITS AND 14 TO 22 CIRCUITS ONLY)

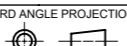
FUNCTIONAL SYMBOLS	THIS DRAWING CONTAINS INFORMATION THAT IS PROPRIETARY TO MOLEX ELECTRONIC TECHNOLOGIES, LLC AND SHOULD NOT BE USED WITHOUT WRITTEN PERMISSION		CURRENT REV DESC: RE-MASTERED IN NX/ECTR				
	$\nabla/A = 0$ $\nabla/E = 0$ $\nabla/P = 0$	DIMENSION UNITS: mm SCALE: NTS					
DIVISIONAL SYMBOLS	INITIAL REVISION:		DOCUMENT NUMBER		DOC TYPE	DOC PART	REVISION
	DRWN: SKTOH 1993/10/26 APPR: LBLEE 2014/07/22		SD-51110-XX5X		PSD	001	B10
DRAFT WHERE APPLICABLE MUST REMAIN WITHIN DIMENSIONS		THIRD ANGLE PROJECTION	DRAWING	SERIES	MATERIAL NUMBER	CUSTOMER	SHEET NUMBER
			A3-SIZE	51110	SEE TABLE	GENERAL MARKET	2 OF 2