



产品编号 : 5601910111

系列号 : 560191

Product Category : Connector Accessories

Product Description : Compactus Wire Dress Cover, Large, 45.30mm Height, Black

状态 : Active

文件和资源

图纸

图纸 [5601910111_sd.pdf](#)

产物环境合规

合规

GADSL/IMDS	Compliant
China RoHS	
EU ELV	Compliant per 2000/53/EC
Low-Halogen Status	Low-Halogen per IEC 61249-2-21
REACH SVHC	Not Contained per D(2023)8585-DC (23 Jan 2024)
EU RoHS	Compliant per EU 2015/863

多部分产品合规性声明

- Eu RoHS
- REACH SVHC
- Low-Halogen
- IPC 1752A Class C
- IPC 1752A Class D
- Molex Product Compliance Declaration
- IEC-62474
- chemSHERPA (xml)

欧盟 RoHS 合格证书

产品详情

常规

状态	活动
类别	Connector Accessories

系列	560191
说明	Compactus Wire Dress Cover, Large, 45.30mm Height, Black
应用	汽车
元件类型	封面
产品系列	Compactus
产品名称	Compactus
UPC	889056077422

物理

回路数（已载入）	不适用
颜色-树脂	黑色
材料 - 树脂	Polyamide
净重	11.841/g
包装形式	Bag

10 9 8 7 6 5 4 3 2 1

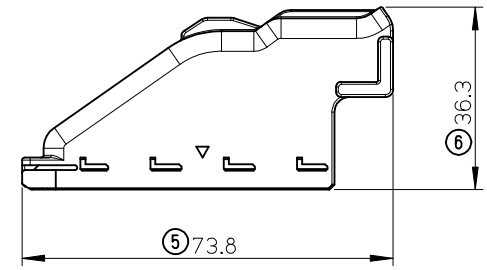
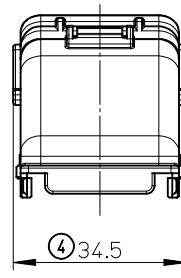
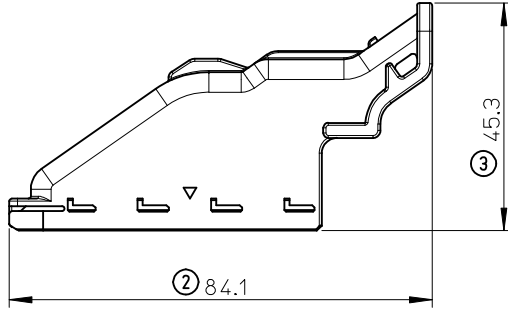
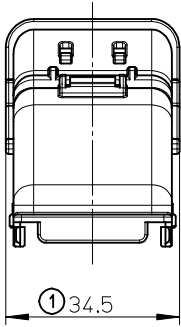
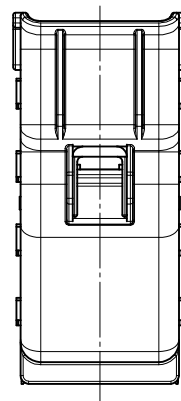
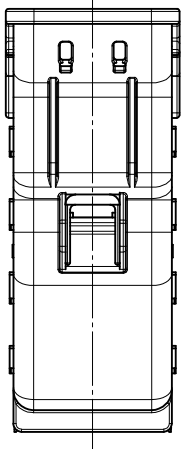

LONG TYPE
560191-0111

SHORT TYPE
560191-0101

- NOTE
- GENERAL TOLERANCES
 $<10: \pm 0.3$
 $10 \leq <30: \pm 0.4$
 $30 \leq : \pm 0.5$
 ANGULAR : $\pm 5^\circ$
 - APPLICABLE CONNECTOR
560155 SERIES
 - MATERIAL: PA, UNFILLED
 - COLOR: BLACK
 - ELV & RoHS COMPLIANT

PROPOSED EC NO: JTR2016-0003 DRWN:SHSHIBATA 2014/08/19 CH'KD:HKOMATSU 2014/08/19 APPR:MAYAMAMOTO 2015/11/12	QUALITY SYMBOLS	GENERAL TOLERANCES (UNLESS SPECIFIED)		DIMENSION STYLE	SCALE	DESIGN UNITS	THIRD ANGLE PROJECTION		
	$F_A=0$	mm	INCH	MM ONLY	1:1	METRIC	TITLE		
	$F_B=0$	4 PLACES ± 0.2	$\pm ---$	DRAWN BY	DATE	WIRE DRESS COVER FOR COMPACTUS molex			
	$F_C=0$	3 PLACES ± 0.25	$\pm ---$	SHSHIBATA	2014/08/19				
$F_D=0$	2 PLACES ± 0.3	$\pm ---$	CHECKED BY	DATE	DOCUMENT NO.				
	1 PLACE ± 0.1	$\pm ---$	HKOMATSU	2014/08/19	SD-560191-001				
	0 PLACE $\pm ---$	$\pm ---$	APPROVED BY	DATE	SHEET NO.				
	ANGULAR $\pm 1^\circ$		MAYAMAMOTO	2015/11/12	1 OF 1				
	DRAFT WHERE APPLICABLE MUST REMAIN WITHIN DIMENSIONS		MATERIAL NO.	---	THIS DRAWING CONTAINS INFORMATION THAT IS PROPRIETARY TO MOLEX INCORPORATED AND SHOULD NOT BE USED WITHOUT WRITTEN PERMISSION				
0	REV			SIZE					
				A3					

9 8 7 6 5 4 3 2 1