

# ■ビニル絶縁付丸形端子(ストレート形)

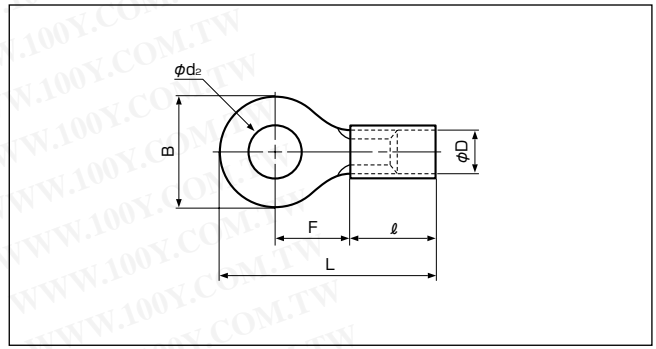

E42024 
 LR20812 
 JQ0608019 
 JIS C 2805

形番	規格	寸法(mm)							標準色	適用電線範囲 燃線(mm <sup>2</sup> )	適用圧着工具			1箱 入数 (個)
		φd2	B	L	F	l	φD	板厚			手動	空気圧式	油圧式	
VO.5-2		2.2	5.2	16.4	5.8	8.0	1.9	0.5	黄	0.2~0.5 (0.2 (AWG#24) 0.3 (AWG#22) 0.5)	YNT-2622	YA-1, YA-2 YAT-1A YAT-2A YAD-1A YAD-2A	BCT-0514L	1,000
VO.5-3		3.2												
VO.5-3.7		3.7												
VO.5-4		4.3												
VO.5-5		5.3												
V1.25-2		2.2	5.5	15.7	4.0	9.0	3.2	0.8	赤	※ 0.25~1.65 ※ (0.3 (AWG#22) 0.5 (AWG#20) 0.75 (AWG#18) 0.9 1.25 (AWG#16))	YNT-2216	YA-1 YA-2 YAT-1A YAT-2A YAD-1A YAD-2A YA-4 YAT-4A YAD-4A	BCT-0514L	1,000
V1.25-3(RAA1.25-3)		3.2												
V1.25-MS3		3.2	17.4	5.6										
V1.25-L3		3.2	8.0	20.0	7.0									
V1.25-3.7		3.7	5.5	15.7	4.0									
V1.25-M3(RAA1.25-3.5)		3.7	6.6	18.6	6.3									
V1.25-M4		4.3	8.0	20.0	7.0									
V1.25-5NS		5.3	9.0	24.6	11.1									
V1.25-5(RAA1.25-5)		5.3	8.0	20.0	7.0									
V1.25-6		6.4	11.6	25.9	11.1									
V1.25-8		8.4												
V1.25-10		10.5	13.6	29.7	13.9									
V2-S2		2.2	6.4	16.5	4.3	9.0	3.9	0.8	青	1.04~2.63 (1.25 (AWG#16) 2.0 (AWG#14))	YNT-1614	YA-1 YA-2 YAT-1A YAT-2A YAD-1A YAD-2A YA-4 YAT-4A YAD-4A	BCT-0514L	1,000
V2-MS3		3.2	5.5	17.4	5.6									
V2-S3.3		3.2	6.4	16.5	4.3									
V2-3		3.2	8.5	21.0	7.8									
V2-S3		3.2	6.4	16.5	4.3									
V2-P3.5		3.7	7.0	20.2	7.7									
V2-M3(RAA2-3.5)		3.7	6.6	18.6	6.3									
V2-M4		4.3	7.0	20.2	7.7									
V2-4(RAA2-4)		4.3	8.5	21.0	7.8									
V2-M5		5.3	9.0	24.5	11.0									
V2-5NS		5.3	9.5	21.0	7.3									
V2-5(RAA2-5)		5.3												
V2-6(RAA2-6)		6.4	12.0	26.0	11.0									
V2-8(RAA2-8)		8.4												
V2-10		10.5	13.6	29.7	13.9									
V2-12		13.0	19.0	35.2	16.7									
V2-14		15.0												
V2-16		17.0	27.0	43.7	21.2									
V2-20		21.0												

注1) ( )はJIS規格形番を示します。なお、JIS規格形番製品とJST形番製品は同一品です。規格No.JIS C 2805







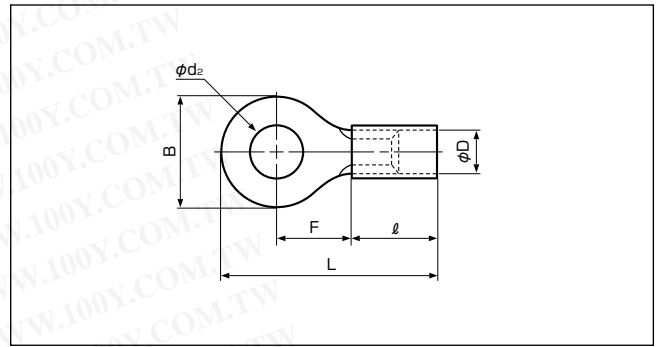

注2) ※印は電線の合計断面積が0.5mm<sup>2</sup>以上となる様にして使用すればより確実になります。(例:0.3mm<sup>2</sup>を2つ折りにして圧着、0.5mm<sup>2</sup>はそのまま圧着)

注3) 本製品の中には多少納期を要するものもあります。

注4) VO.5-( )におけるUL登録の適用電線はAWG#26~AWG#22です。

勝特力材料 886-3-5753170  
 胜特力电子(上海) 86-21-34970699  
 胜特力电子(深圳) 86-755-83298787  
[Http://www.100y.com.tw](http://www.100y.com.tw)



形番	規格	寸法(mm)						標準色	適用電線範囲			適用圧着工具			1箱 入数 (個)
		φd2	B	L	F	ℓ	φD		板厚	撚線(mm <sup>2</sup> )	手動	空気圧式	油圧式		
V5.5-3	 	3.2	9.5	26.5	8.3	13.5	5.4	1.0	黄	2.63~6.64 (3.5(AWG#12) 5.5(AWG#10))	YNT-1210S	YA-4 YAT-4A YAD-4A	BCT-0514L	500	
V5.5-S3	 	3.7	7.2	23.0	5.9										
V5.5-S4	 	4.3	9.5	26.5	8.3										
V5.5-4(RAA5.5-4)	 														
V5.5-5(RAA5.5-5)	 	5.3	13.2	29.1	9.0										
V5.5-S5	 														
V5.5-6(RAA5.5-6)	 	6.4	12.0	32.5	13.0										
V5.5-S6	 														
V5.5-S8	 	8.4	13.2	29.1	9.0										
V5.5-8(RAA5.5-8)	 														
V5.5-10(RAA5.5-10)	 	10.5	15.0	34.7	13.7										
V5.5-12	 														
V5.5-14	 	32.0	54.8	25.3											
V5.5-16	 														
V5.5-18	 														
V5.5-20	 														

注1) ( )はJIS規格形番を示します。なお、JIS規格形番製品とJST形番製品は同一品です。規格No.JIS C 2805

注2) 本製品の中には多少納期を要するものもあります。

**勝特力材料 886-3-5753170**  
**胜特力电子(上海) 86-21-34970699**  
**胜特力电子(深圳) 86-755-83298787**  
[Http://www.100y.com.tw](http://www.100y.com.tw)

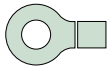

# ビニル絶縁付丸形端子 (F形)

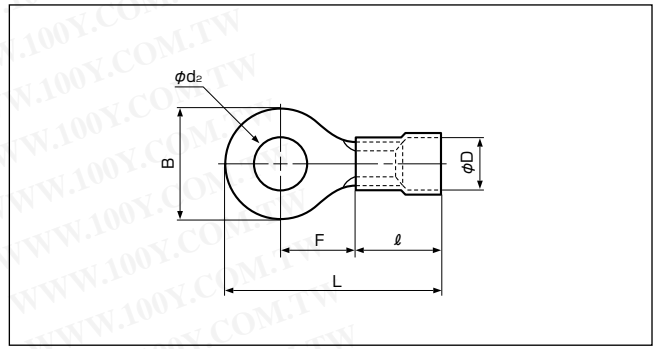

E42024 
 LR20812 
 JQ0608019 
 JIS C 2805

形番	規格	寸法(mm)							標準色	適用電線範囲 撚線(mm <sup>2</sup> )	適用圧着工具			1箱 入数 (個)
		$\phi d_2$	B	L	F	$\ell$	$\phi D$	板厚			手動	空気圧式	油圧式	
FV0.5-2		2.2	5.2	16.4	5.8	8.0	2.9	0.5	黄	0.2~0.5 (0.2 (AWG#24) 0.3 (AWG#22) 0.5	YNT-2622	YA-1, YA-2 YAT-1A YAT-2A YAD-1A YAD-2A	BCT-0514L	1,000
FV0.5-3		3.2												
FV0.5-3.7		3.7												
FV0.5-4		4.3												
FV0.5-5		5.3												
FV1.25-2		2.2	5.5	15.7	4.0	9.0	4.0	0.8	赤	※ 0.25~1.65 ※ (0.3 (AWG#22) 0.5 (AWG#20) 0.75 (AWG#18) 0.9 (1.25 (AWG#16))	YNT-2216	YA-1 YA-2 YAT-1A YAT-2A YAD-1A YAD-2A YA-4 YAT-4A YAD-4A	BCT-0514L	1,000
FV1.25-3(RBA1.25-3)		3.2												
FV1.25-MS3		3.2												
FV1.25-L3		3.2												
FV1.25-3.7		3.7												
FV1.25-M3(RBA1.25-3.5)		3.7	6.6	18.6	6.3	9.0	4.0	0.8	青	1.04~2.63 (1.25 (AWG#16) 2.0 (AWG#14))	YNT-1614	YA-1 YA-2 YAT-1A YAT-2A YAD-1A YAD-2A YA-4 YAT-4A YAD-4A	BCT-0514L	1,000
FV1.25-M4		4.3												
FV1.25-4(RBA1.25-4)		4.3												
FV1.25-5(RBA1.25-5)		5.3												
FV1.25-6		6.4												
FV1.25-8		8.4	11.6	25.9	11.1	9.0	4.5	0.8	青	1.04~2.63 (1.25 (AWG#16) 2.0 (AWG#14))	YNT-1614	YA-1 YA-2 YAT-1A YAT-2A YAD-1A YAD-2A YA-4 YAT-4A YAD-4A	BCT-0514L	1,000
FV1.25-10		10.5												
FV2-S2		2.2												
FV2-MS3		3.2												
FV2-S3.3		3.2												
FV2-3		3.7	6.6	18.6	6.3	9.0	4.5	0.8	青	1.04~2.63 (1.25 (AWG#16) 2.0 (AWG#14))	YNT-1614	YA-1 YA-2 YAT-1A YAT-2A YAD-1A YAD-2A YA-4 YAT-4A YAD-4A	BCT-0514L	1,000
FV2-S3		3.7												
FV2-P3.5		3.7												
FV2-M3(RBA2-3.5)		3.7												
FV2-M4		4.3												
FV2-P4		4.3	8.5	21.0	7.8	9.0	4.5	0.8	青	1.04~2.63 (1.25 (AWG#16) 2.0 (AWG#14))	YNT-1614	YA-1 YA-2 YAT-1A YAT-2A YAD-1A YAD-2A YA-4 YAT-4A YAD-4A	BCT-0514L	1,000
FV2-4(RBA2-4)		4.3												
FV2-M5		5.3												
FV2-5(RBA2-5)		5.3												
FV2-6(RBA2-6)		6.4												
FV2-8(RBA2-8)		8.4	12.0	26.0	11.0	9.0	4.5	0.8	青	1.04~2.63 (1.25 (AWG#16) 2.0 (AWG#14))	YNT-1614	YA-1 YA-2 YAT-1A YAT-2A YAD-1A YAD-2A YA-4 YAT-4A YAD-4A	BCT-0514L	1,000
FV2-10		10.5												
FV2-12		13.0												
FV2-14		15.0												
FV2-16		17.0												
FV2-20		21.0	27.0	43.7	21.2	9.0	4.5	0.8	青	1.04~2.63 (1.25 (AWG#16) 2.0 (AWG#14))	YNT-1614	YA-1 YA-2 YAT-1A YAT-2A YAD-1A YAD-2A YA-4 YAT-4A YAD-4A	BCT-0514L	1,000
FV2-12		13.0												
FV2-14		15.0												
FV2-16		17.0												
FV2-20		21.0												

注1) ( )はJIS規格形番を示します。なお、JIS規格形番製品とJST形番製品は同一品です。規格No.JIS C 2805









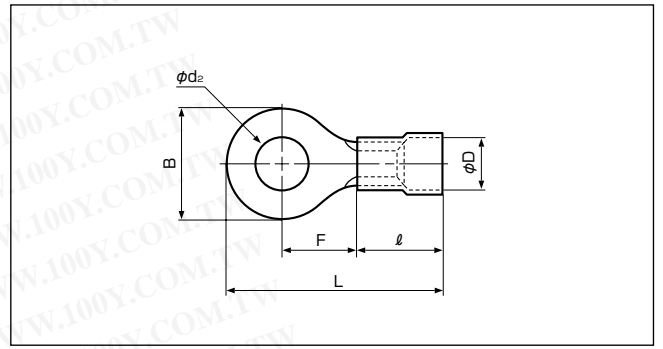





























注2) ※印は電線の合計断面積が0.5mm<sup>2</sup>以上となる様にして使用すればより確実になります。(例:0.3mm<sup>2</sup>を2つ折りにして圧着、0.5mm<sup>2</sup>はそのまま圧着)

注3) 本製品の中には多少納期を要するものもあります。

注4) FV0.5-( )におけるUL登録の適用電線はAWG#26~AWG#22です。

勝特力材料 886-3-5753170  
 胜特力电子(上海) 86-21-34970699  
 胜特力电子(深圳) 86-755-83298787  
[Http://www.100y.com.tw](http://www.100y.com.tw)



形 番	規 格	寸 法(mm)						標準色	適用電線範囲			1箱 入数 (個)		
		φd2	B	L	F	ℓ	φD		板厚	燃線(mm <sup>2</sup> )	手 動		空気圧式	油 圧 式
FV5.5-S3.3	 	3.2	7.2	23.0	5.9	13.5	6.8	1.0	黄	2.63~6.64 (3.5(AWG#12)) (5.5(AWG#10))	YNT-1210S	YA-4 YAT-4A YAD-4A	BCT-0514L	500
FV5.5-3	 		9.5	26.5	8.3									
FV5.5-S3	 	3.7	7.2	23.0	5.9									
FV5.5-S4	 		4.3	9.5	26.5									
FV5.5-4(RBA5.5-4)	  													
FV5.5-5(RBA5.5-5)	  	5.3	13.2	29.1	9.0									
FV5.5-S5	 													
FV5.5-6(RBA5.5-6)	  	6.4	12.0	32.5	13.0									
FV5.5-S6	 													
FV5.5-S8	 	8.4	13.2	29.1	9.0									
FV5.5-8(RBA5.5-8)	  													
FV5.5-10(RBA5.5-10)	  	10.5	15.0	34.7	13.7									
FV5.5-12	 													
FV5.5-14	 	15.0	32.0	54.8	25.3									
FV5.5-16	 													
FV5.5-18	 													
FV5.5-20	 													

注1) ( )はJIS規格形番を示します。なお、JIS規格形番製品とJST形番製品は同一品です。規格No.JIS C 2805

注2) 本製品の中には多少納期を要するものもあります。

勝特力材料 886-3-5753170  
 胜特力电子(上海) 86-21-34970699  
 胜特力电子(深圳) 86-755-83298787  
[Http://www.100y.com.tw](http://www.100y.com.tw)

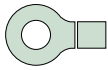

# ■ナイロン絶縁付丸形端子(ストレート形)

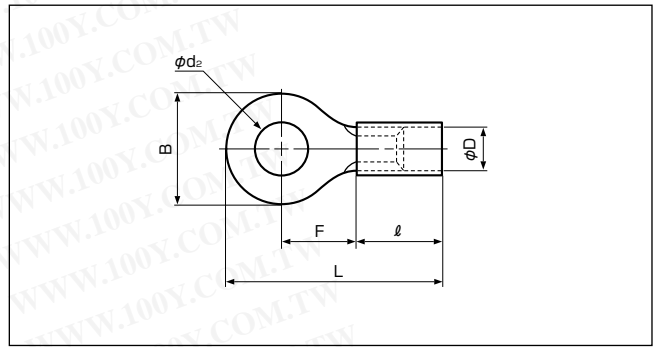

E42024 
 LR20812 
 JQ0608019 
 JIS C 2805

形番	規格	寸法(mm)							標準色	適用電線範囲 撚線(mm <sup>2</sup> )	適用圧着工具			1箱 入数 (個)
		φd2	B	L	F	ℓ	φD	板厚			手動	空気圧式	油圧式	
N0.5-2		2.2	5.2	16.4	5.8	8.0	1.9	0.5	黄透明	0.2~0.5 (0.2 (AWG#24) 0.3 (AWG#22) 0.5)	YNT-2622	YA-1, YA-2	BCT-0514L	1,000
N0.5-3		3.2			7.7									
N0.5-3.7		3.7			7.7									
N0.5-4		4.3			7.0									
N0.5-5		5.3			7.0									
N1.25-2		2.2	5.5	15.7	4.0	9.0	3.2	0.8	赤	※ 0.25~1.65 ※ (0.3 (AWG#22) 0.5 (AWG#20) 0.75 (AWG#18) 0.9 (1.25 (AWG#16))	YNT-2216	YA-1	BCT-0514L	1,000
N1.25-3(RAC1.25-3)		3.2			5.6									
N1.25-MS3		3.2	17.4	5.6										
N1.25-L3		3.2	8.0	20.0	7.0									
N1.25-3.7		3.7	5.5	15.7	4.0									
N1.25-M3(RAC1.25-3.5)		3.7	6.6	18.6	6.3									
N1.25-M4		4.3	8.0	20.0	7.0									
N1.25-4(RAC1.25-4)		4.3	8.0	20.0	7.0									
N1.25-5(RAC1.25-5)		5.3	8.0	20.0	7.0									
N1.25-6		6.4	11.6	25.9	11.1									
N1.25-8		8.4	13.6	29.7	13.9									
N1.25-10		10.5	13.6	29.7	13.9									
N2-S2		2.2	6.4	16.5	4.3	9.0	3.9	0.8	青	1.04~2.63 (1.25 (AWG#16) 2.0 (AWG#14))	YNT-1614	YA-1	BCT-0514L	500
N2-MS3		3.2	5.5	17.4	5.6									
N2-S3.3		3.2	6.4	16.5	4.3									
N2-3		3.2	8.5	21.0	7.8									
N2-S3		3.2	6.4	16.5	4.3									
N2-P3.5		3.7	7.0	20.2	7.7									
N2-M3(RAC2-3.5)		3.7	6.6	18.6	6.3									
N2-M4		4.3	7.0	20.2	7.7									
N2-4(RAC2-4)		4.3	8.5	21.0	7.8									
N2-M5		5.3	9.5	21.0	7.3									
N2-5(RAC2-5)		5.3	9.5	21.0	7.3									
N2-6(RAC2-6)		6.4	12.0	26.0	11.0									
N2-8(RAC2-8)		8.4	12.0	26.0	11.0									
N2-10		10.5	13.6	29.7	13.9									
N2-12		13.0	19.0	35.2	16.7									
N2-14		15.0	27.0	43.7	21.2									
N2-16		17.0	27.0	43.7	21.2									
N2-20		21.0	27.0	43.7	21.2									

注1) ( )はJIS規格形番を示します。なお、JIS規格形番製品とJST形番製品は同一品です。規格No. JIS C 2805

注2) ※印は電線の合計断面積が0.5mm<sup>2</sup>以上となる様にして使用すればより確実になります。(例:0.3mm<sup>2</sup>を2つ折りにして圧着、0.5mm<sup>2</sup>はそのまま圧着)

注3) 本製品の中には多少納期を要するものもあります。

注4) N0.5-( )におけるUL登録の適用電線はAWG#26~AWG#22です。

●ナイロンは吸湿性がありますので保管等にご注意ください。

勝特力材料 886-3-5753170  
 胜特力电子(上海) 86-21-34970699  
 胜特力电子(深圳) 86-755-83298787  
[Http://www.100y.com.tw](http://www.100y.com.tw)

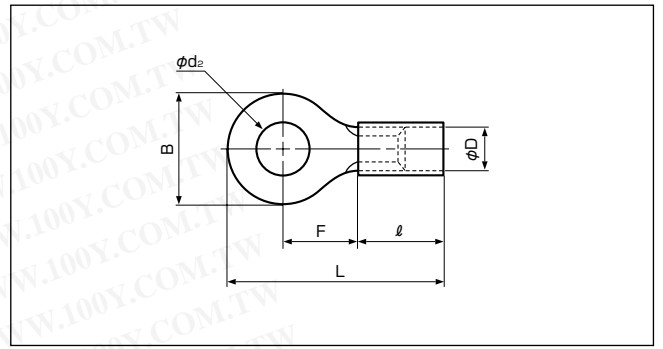

形番	規格	寸法(mm)						標準色	適用電線範囲 撚線(mm <sup>2</sup> )	適用圧着工具			1箱 入数 (個)	
		$\phi d_2$	B	L	F	$\ell$	$\phi D$			板厚	手動	空気圧式		油圧式
N5.5-3		3.2	9.5	26.5	8.3				2.63~6.64 (3.5(AWG#12) 5.5(AWG#10))	YNT-1210S	YA-4 YAT-4A YAD-4A	BCT-0514L	500	
N5.5-S3		3.7	7.2	23.0	5.9	13.5	5.4	1.0						黄
N5.5-S4		4.3												
N5.5-4(RAC5.5-4)		5.3	9.5	26.5	8.3									
N5.5-5(RAC5.5-5)														
N5.5-S5		5.3	13.2	29.1	9.0									
N5.5-6(RAC5.5-6)		6.4	12.0	32.5	13.0									
N5.5-S6														
N5.5-S8		8.4	13.2	29.1	9.0									
N5.5-8(RAC5.5-8)														
N5.5-10(RAC5.5-10)		10.5	15.0	34.7	13.7									
N5.5-12		13.0	19.2	39.1	16.0									
N5.5-14		15.0	32.0	54.8	25.3									
N5.5-16		17.0												
N5.5-18		19.0												
N5.5-20		21.0												
													250	

注1) ( )はJIS規格形番を示します。なお、JIS規格形番製品とJST形番製品は同一品です。規格No. JIS C 2805

注2) 本製品の中には多少納期を要するものもあります。

● ナイロンは吸湿性がありますので保管等にご注意ください。

勝特力材料 886-3-5753170  
 胜特力电子(上海) 86-21-34970699  
 胜特力电子(深圳) 86-755-83298787  
[Http://www.100y.com.tw](http://www.100y.com.tw)

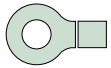

# ■ナイロン絶縁付丸形端子(F形)

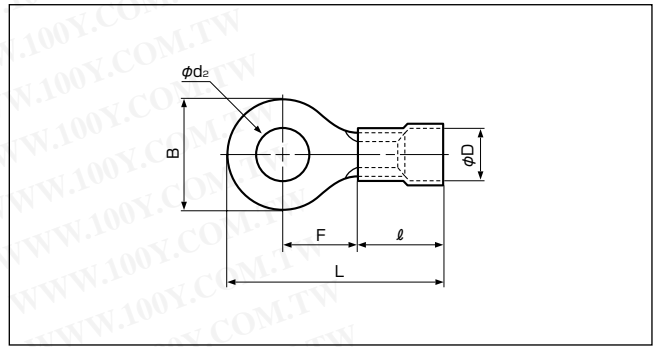

E42024 
 LR20812 
 JQ0608019 
 JIS C 2805

形番	規格	寸法(mm)							標準色	適用電線範囲 撚線(mm <sup>2</sup> )	適用圧着工具			1箱 入数 (個)
		φd2	B	L	F	ℓ	φD	板厚			手動	空気圧式	油圧式	
FN0.5-2		2.2	5.2	16.4	5.8	8.0	2.9	0.5	黄透明	0.2~0.5 (0.2 (AWG#24) 0.3 (AWG#22) 0.5)	YNT-2622	YA-1 YA-2 YAT-1A YAT-2A YAD-1A YAD-2A	BCT-0514L	1,000
FN0.5-3		3.2	6.6	19.0	7.7									
FN0.5-3.7		3.7	6.6	19.0	7.7									
FN0.5-4		4.3	8.0	7.0	7.0									
FN0.5-5		5.3	8.0	7.0	7.0									
FN1.25-2		2.2	5.5	15.7	4.0	9.0	4.0	0.8	赤	※ 0.25~1.65 ※ (0.3 (AWG#22) 0.5 (AWG#20) 0.75 (AWG#18) 0.9 (1.25 (AWG#16))	YNT-2216	YA-1 YA-2 YAT-1A YAT-2A YAD-1A YAD-2A YA-4 YAT-4A YAD-4A	BCT-0514L	1,000
FN1.25-3(RBC1.25-3)		3.2		17.4	5.6									
FN1.25-MS3		3.2	8.0	20.0	7.0									
FN1.25-L3		3.7	5.5	15.7	4.0									
FN1.25-3.7		3.7	6.6	18.6	6.3									
FN1.25-M3(RBC1.25-3.5)		5.3	8.0	20.0	7.0									
FN1.25-M4		4.3	8.0	20.0	7.0									
FN1.25-4(RBC1.25-4)		5.3	8.0	20.0	7.0									
FN1.25-5(RBC1.25-5)		5.3	8.0	20.0	7.0									
FN1.25-6		6.4	11.6	25.9	11.1									
FN1.25-8		8.4	13.6	29.7	13.9									
FN1.25-10		10.5	13.6	29.7	13.9									
FN2-S2		2.2	6.4	16.5	4.3	9.0	4.5	0.8	青	1.04~2.63 (1.25 (AWG#16) 2.0 (AWG#14))	YNT-1614	YA-1 YA-2 YAT-1A YAT-2A YAD-1A YAD-2A YA-4 YAT-4A YAD-4A	BCT-0514L	500
FN2-MS3		3.2	5.5	17.4	5.6									
FN2-S3.3		3.2	6.4	16.5	4.3									
FN2-3		3.7	8.5	21.0	7.8									
FN2-S3		3.7	6.4	16.5	4.3									
FN2-P3.5		3.7	7.0	20.2	7.7									
FN2-M3(RBC2-3.5)		5.3	6.6	18.6	6.3									
FN2-M4		4.3	7.0	20.2	7.7									
FN2-4(RBC2-4)		5.3	8.5	21.0	7.8									
FN2-M5		5.3	9.5	7.3	7.3									
FN2-5(RBC2-5)		6.4	12.0	26.0	11.0									
FN2-6(RBC2-6)		8.4	12.0	26.0	11.0									
FN2-8(RBC2-8)		8.4	12.0	26.0	11.0									
FN2-10		10.5	13.6	29.7	13.9									
FN2-12		13.0	19.0	35.2	16.7									
FN2-14		15.0	27.0	43.7	21.2									
FN2-16		17.0	27.0	43.7	21.2									
FN2-20		21.0	27.0	43.7	21.2									

注1) ( )はJIS規格形番を示します。なお、JIS規格形番製品とJST形番製品は同一品です。規格No. JIS C 2805

注2) ※印は電線の合計断面積が0.5mm<sup>2</sup>以上となる様にして使用すればより確実になります。(例:0.3mm<sup>2</sup>を2つ折りにして圧着、0.5mm<sup>2</sup>はそのまま圧着)

注3) 本製品の中には多少納期を要するものもあります。

注4) FN0.5-( )におけるUL登録の適用電線はAWG#26~AWG#22です。

●ナイロンは吸湿性がありますので保管等にご注意ください。

勝特力材料 886-3-5753170  
 勝特力電子(上海) 86-21-34970699  
 勝特力電子(深圳) 86-755-83298787  
[Http://www.100y.com.tw](http://www.100y.com.tw)

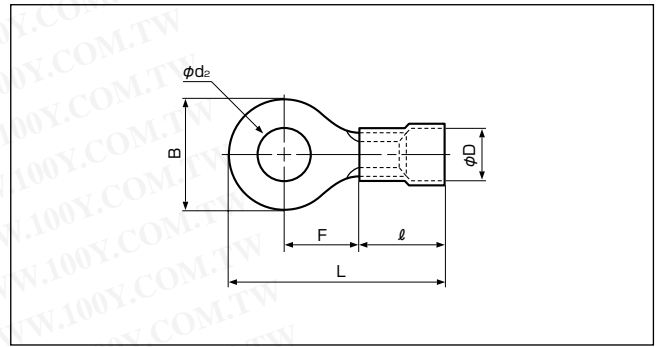

形 番	規 格	寸 法 (mm)							標準色	適用電線範囲 撚線(mm <sup>2</sup> )	適用圧着工具			1箱 入数 (個)
		φd <sub>2</sub>	B	L	F	ℓ	φD	板厚			手 動	空気圧式	油 圧 式	
FN5.5-3		3.2	9.5	26.5	8.3	13.5	6.8	1.0	黄	2.63~6.64 (3.5 (AWG#12)) (5.5 (AWG#10))	YNT-1210S	YA-4 YAT-4A YAD-4A	BCT-0514L	500
FN5.5-S3		3.7	7.2	23.0	5.9									
FN5.5-S4		4.3	9.5	26.5	8.3									
FN5.5-4(RBC5.5-4)														
FN5.5-5(RBC5.5-5)		5.3	13.2	29.1	9.0									
FN5.5-S5														
FN5.5-6(RBC5.5-6)		6.4	12.0	32.5	13.0									
FN5.5-S6														
FN5.5-S8		8.4	13.2	29.1	9.0									
FN5.5-8(RBC5.5-8)														
FN5.5-10(RBC5.5-10)		10.5	15.0	34.7	13.7									
FN5.5-12		13.0	19.2	39.1	16.0									
FN5.5-14		15.0	32.0	54.8	25.3									
FN5.5-16		17.0												
FN5.5-18		19.0												
FN5.5-20		21.0												

注1) ( )はJIS規格形番を示します。なお、JIS規格形番製品とJST形番製品は同一品です。規格No. JIS C 2805

注2) 本製品の中には多少納期を要するものもあります。

● ナイロンは吸湿性がありますので保管等にご注意ください。

**勝特力材料 886-3-5753170**  
**胜特力电子(上海) 86-21-34970699**  
**胜特力电子(深圳) 86-755-83298787**  
[Http://www.100y.com.tw](http://www.100y.com.tw)