

SMH · 厂家直销

# 单极大电流电源连接器

注：每买一个插头默认送一个铜质端子



## 检验认证报告

SMH每款产品经过严格的检测认证，拒绝伪劣产品

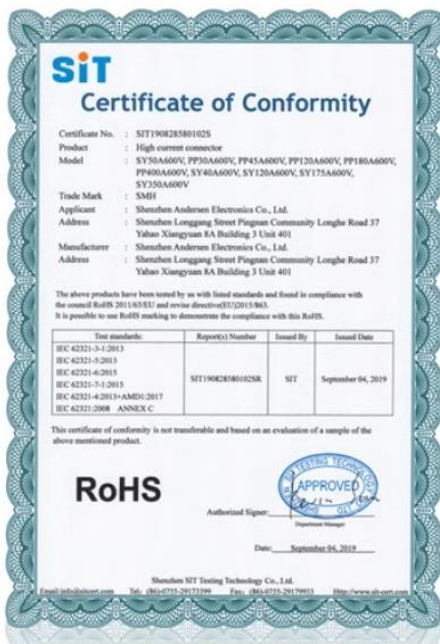

# 产品参数

PRODUCT PARAMETERS

	产品型号：30A单极插头
	外壳材质：PC阻燃材质
	端子材质：铜质端子
外壳颜色：灰红蓝黄绿黑白7种可选	
端子接线规格：国标线 $1.5\text{mm}^2\sim 4\text{mm}^2$ 美标线16AWG~12AWG	

	产品型号：75A单极插头
	外壳材质：PC阻燃材质
	端子材质：铜质端子
外壳颜色：红蓝黄绿黑白6种可选	
端子接线规格：国标线 $4\text{mm}^2\sim 16\text{mm}^2$ 美标线12AWG~6AWG	

	<b>产品型号：120A单极插头</b>
	<b>外壳材质：PC阻燃材质</b>
	<b>端子材质：铜质端子</b>
<b>外壳颜色：红蓝黄绿黑白6种可选</b>	
<b>端子接线规格：国标线13.3mm<sup>2</sup>~35mm<sup>2</sup> 美标线6AWG~2AWG</b>	

	<b>产品型号：180A单极插头</b>
	<b>外壳材质：PC阻燃材质</b>
	<b>端子材质：铜质端子</b>
<b>外壳颜色：红蓝黄绿黑白6种可选</b>	
<b>端子接线规格：国标线35mm<sup>2</sup>~55mm<sup>2</sup> 美标线2AWG~1/0AWG</b>	

	<b>产品型号：350A单极插头</b>
	<b>外壳材质：PC阻燃材质</b>
	<b>端子材质：铜质端子</b>
<b>外壳颜色：红黑2种可选</b>	
<b>端子接线规格：国标线10mm<sup>2</sup>~70mm<sup>2</sup> 美标线2/0AWG</b>	

# 1、连接原理

1、模铸燕尾榫设计  
可全方位自由组装

2、不锈钢板簧提供  
恒定的接触压力

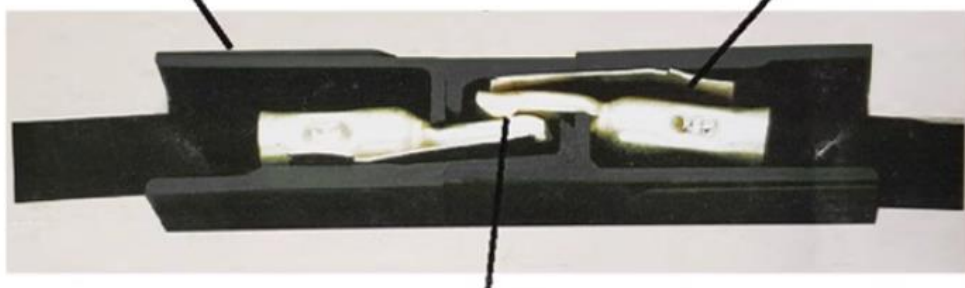

3、自擦净设计，接通和断开时的  
擦拭动作使导电表面保持清洁

**\*插头剖开解析图  
(连接原理)**

## 任意颜色对接

连接器可以根据自身电源连接需求轻松定制，从各种不同颜色的外壳中选择，并将它们堆叠成多位置连接。耐用的铜质端子压接并插入外壳，可用于各种尺寸的电线

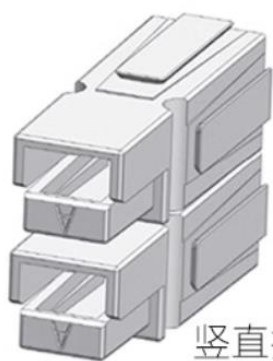

竖直排列

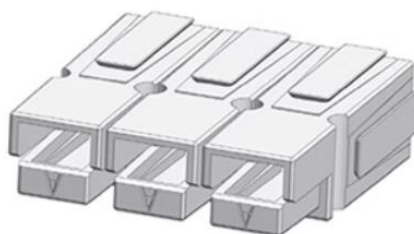

水平排列

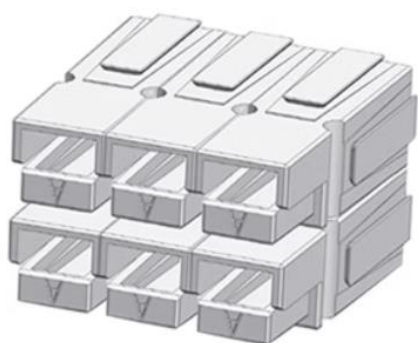

水平竖直排列

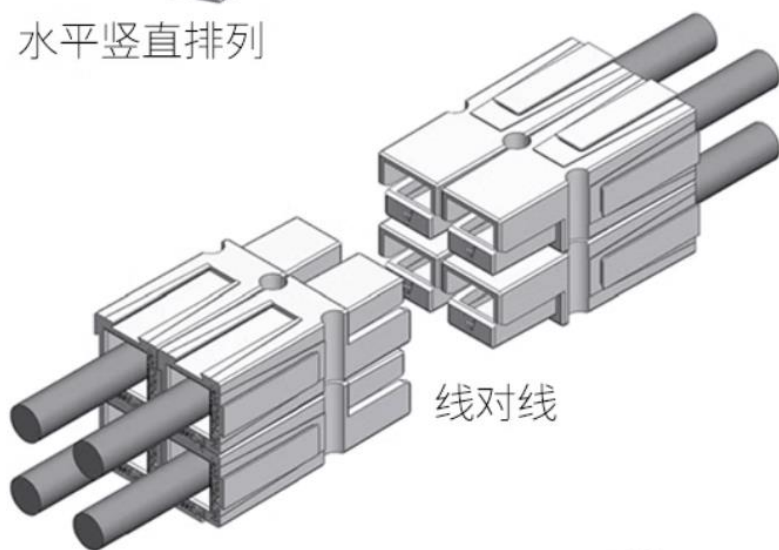

线对线

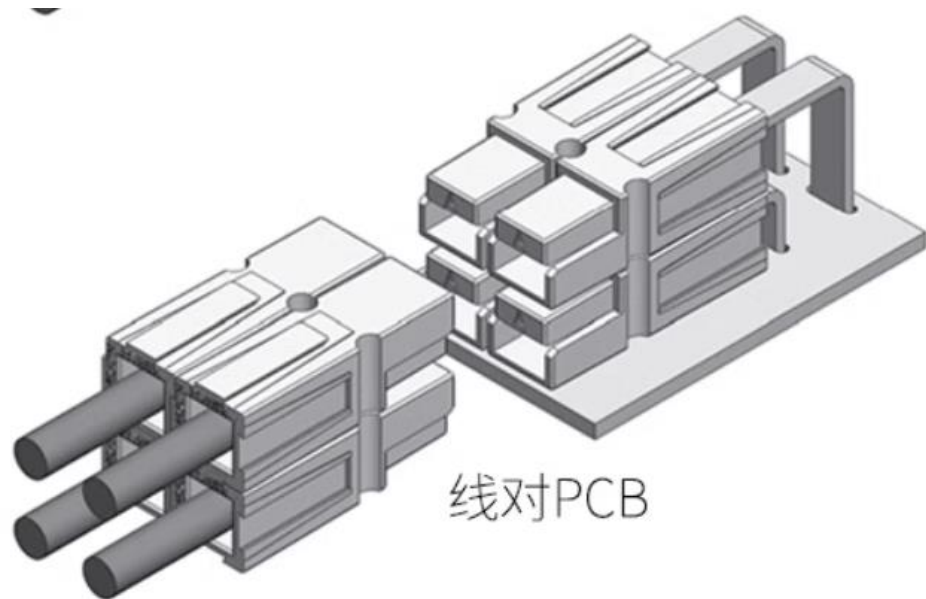

线对PCB