

T-25 LOADED BOARD PROBE

勝特力材料 886-3-5753170
 勝特力电子(上海) 86-21-34970699
 勝特力电子(深圳) 86-755-83298787
[Http://www.100y.com.tw](http://www.100y.com.tw)

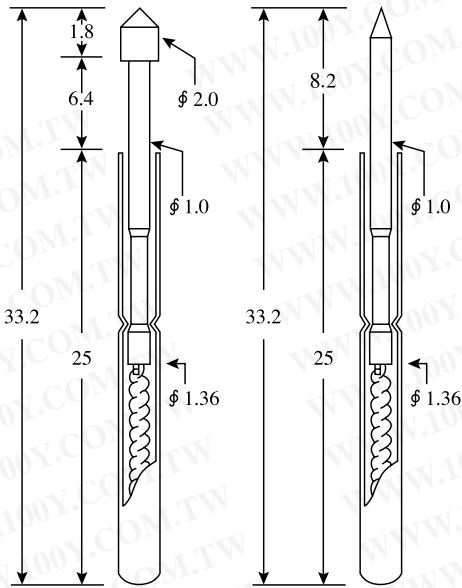

最小間距 (Recommended Min Center)	2.54m/m
鑽孔尺寸 (Drill Size)	1.7m/m 1.75m/m
材質 (Materials)	PLUNGER:RH.PLATED BE CU BARREL:AU.PLATED BRASS
行程 (Full Travel)	6.4m/m
全壓彈力 (Spring Pressure)	80g,120g,180g,250g,300g,350g
額定電流 (Current Rating)	3A
接觸電阻 (Contact Resistance)	50mΩ

單位 : m/m DIMENSION IN MILLIMETER

T25-0.7B

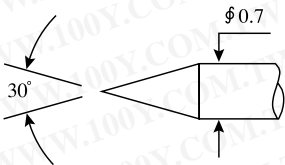

T25-1.0B

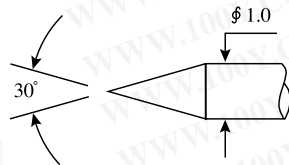

T25-1.0F

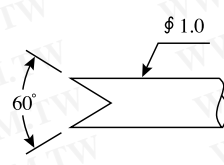

T25-1.0F2

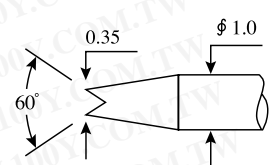

T25-1.0G

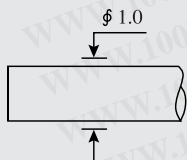

T25-1.0D

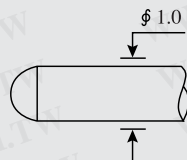

T25-1.0T

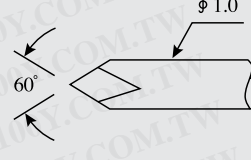

T25-1.3A

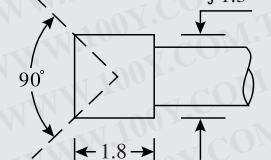

T25-1.5A

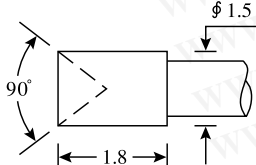

T25-1.5D

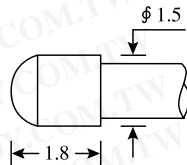

T25-1.5E

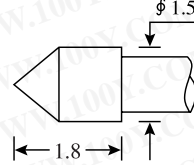

T25-1.5F

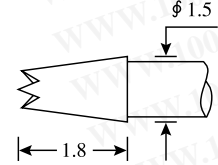

T25-1.5

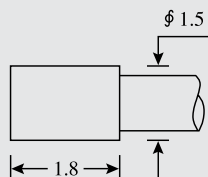

T25-1.5H

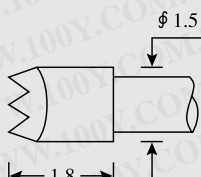

T25-1.5K

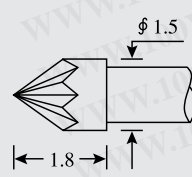

T25-1.5Q

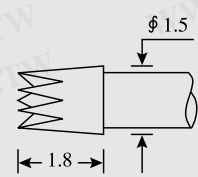

T-25 LOADED BOARD PROBE

勝特力材料 886-3-5753170
 勝特力电子(上海) 86-21-34970699
 勝特力电子(深圳) 86-755-83298787
[Http://www.100y.com.tw](http://www.100y.com.tw)

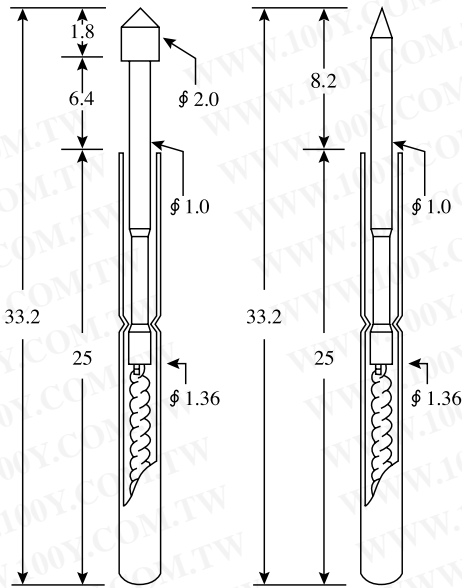

最小間距 (Recommended Min Center)	2.54m/m
鑽孔尺寸 (Drill Size)	1.7m/m 1.75m/m
材質 (Materials)	PLUNGER:RH.PLATED BE CU BARREL:AU.PLATED BRASS
行程 (Full Travel)	6.4m/m
全壓彈力 (Spring Pressure)	80g,120g,180g,250g, 300g,350g
額定電流 (Current Rating)	3A
接觸電阻 (Contact Resistance)	50mΩ

單位 : m/m DIMENSION IN MILLIMETER

T25-1.5T

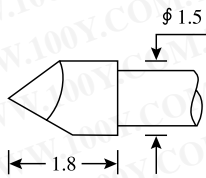

T25-1.8H

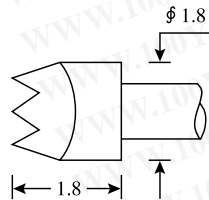

T25-2.0E

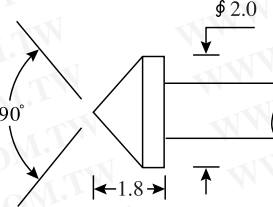

T25-2.0H

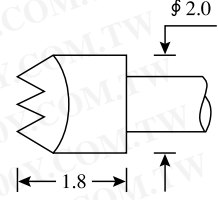

T25-2.0K

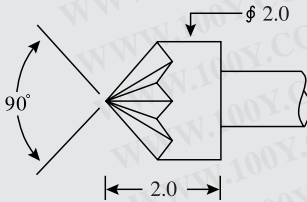

T25-2.5H

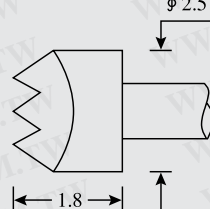

T25-2.5K

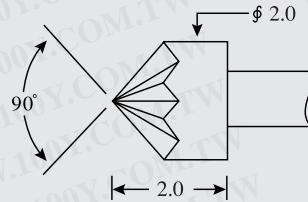

T25-3.0H

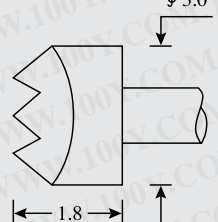

T25-3.0K

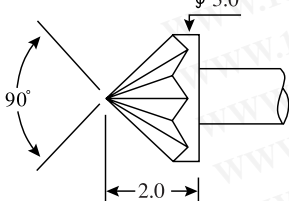

T25-3.0T

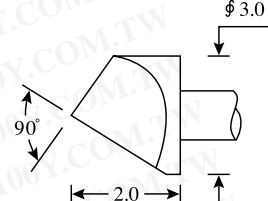

T25-4.0H

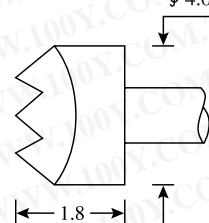

T25-4.0K

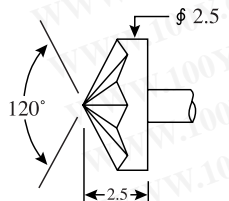

T25-4.0

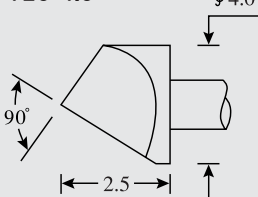

T25-M3

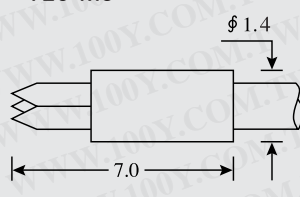

25# PRECISION RECEPTACLES

勝特力材料 886-3-5753170
 勝特力电子(上海) 86-21-34970699
 勝特力电子(深圳) 86-755-83298787
[Http://www.100y.com.tw](http://www.100y.com.tw)

最小間距 (Recommended Min Center)	2.54m/m
鑽孔尺寸 (Drill Size)	1.7m/m ; 1.75m/m
材質 (Materials)	Cold Plated Brass
接線形式 (Connections) :	
壓接 Press	: 8VC 8W2C 8W3C 8W4C : 25W1C 25W2C 25W3C 25W4C 25W5C
銲接 Solder	: 8VS 8W2S 8W3S 8W4S : 25W1S 25W2S 25W3S 25W4S 25W5S
繞接 Wire Wrap	: 8V-2 8W2-2 8W3-2 8W4-2 : 25W1-2 25W2-2 25W3-2 25W4-2 25W5-2
端子 Terminal	: 25W1T 25W2T 25W3T 25W4T 25W5T

單位 : m/m DIMENSION IN MILLIMETER

R-8VC

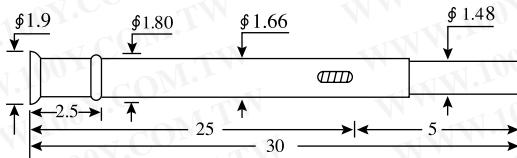

R-8W2C

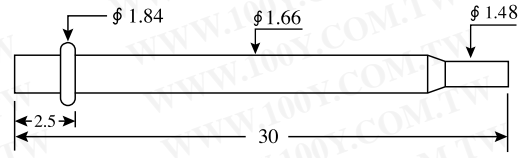

R-8W3C

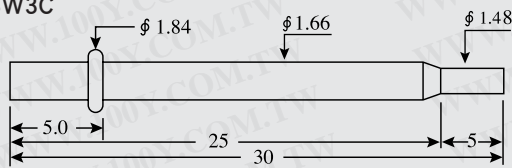

R-8W4C

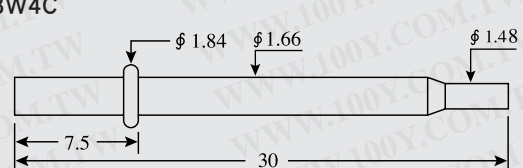

R-25W1C

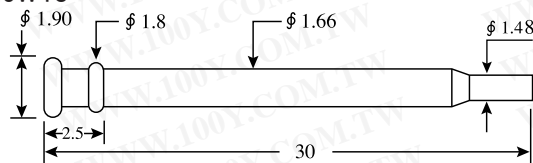

R-25W2C

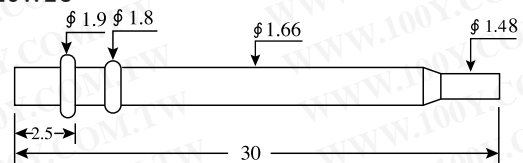

R-25W3C

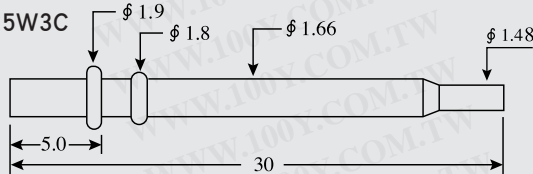

R-25W4C

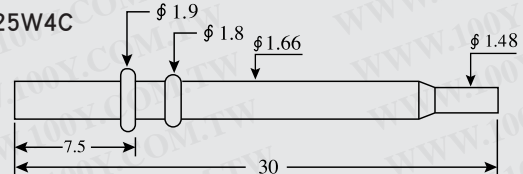

R-25W5C

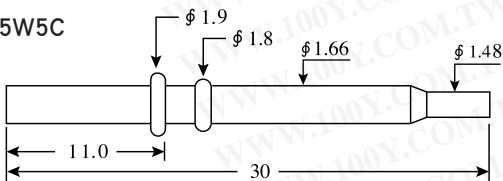

R-8VS

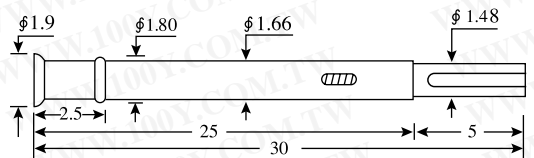

R-8W2S

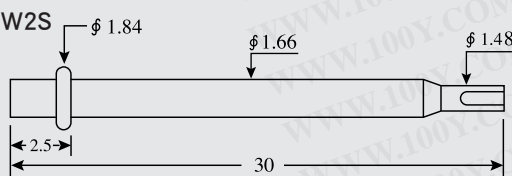

R-8W3S

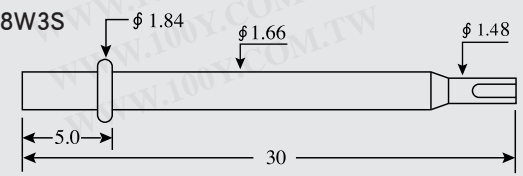

25# PRECISION RECEPTACLES

勝特力材料 886-3-5753170
 勝特力电子(上海) 86-21-34970699
 勝特力电子(深圳) 86-755-83298787
[Http://www.100y.com.tw](http://www.100y.com.tw)

最小間距 (Recommended Min Center)	2.54m/m
鑽孔尺寸 (Drill Size)	1.7m/m ; 1.75m/m
材質 (Materials)	Cold Plated Brass
接線形式 (Connections) :	
壓接 Press	: 8VC 8W2C 8W3C 8W4C : 25W1C 25W2C 25W3C 25W4C 25W5C
銲接 Solder	: 8VS 8W2S 8W3S 8W4S : 25W1S 25W2S 25W3S 25W4S 25W5S
繞接 Wire Wrap	: 8V-2 8W2-2 8W3-2 8W4-2 : 25W1-2 25W2-2 25W3-2 25W4-2 25W5-2
端子 Terminal	: 25W1T 25W2T 25W3T 25W4T 25W5T

單位 : m/m DIMENSION IN MILLIMETER

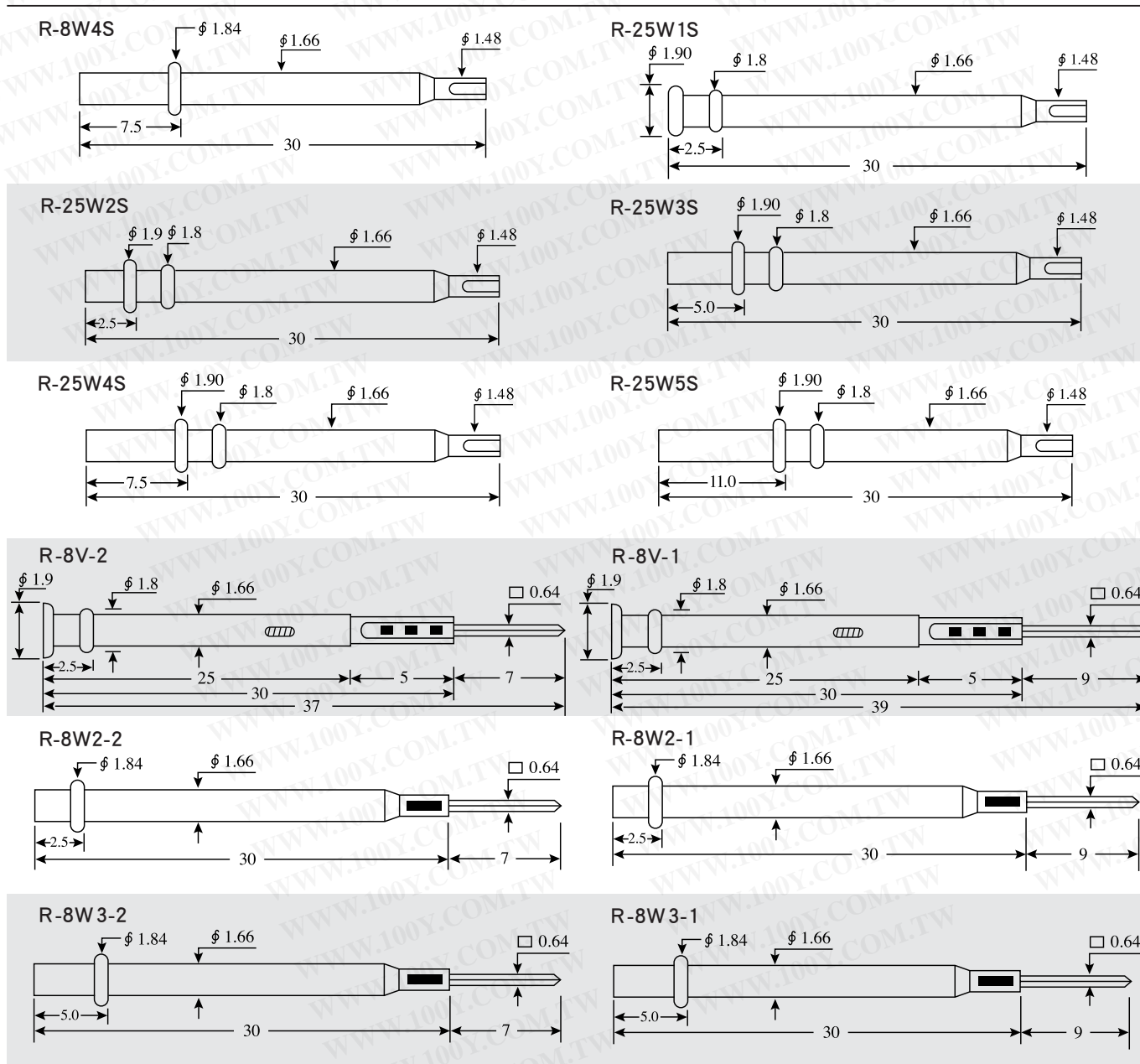

25# PRECISION RECEPTACLES

勝特力材料 886-3-5753170
 勝特力电子(上海) 86-21-34970699
 勝特力电子(深圳) 86-755-83298787
[Http://www.100y.com.tw](http://www.100y.com.tw)

最小間距 (Recommended Min Center)	2.54m/m
鑽孔尺寸 (Drill Size)	1.7m/m ; 1.75m/m
材質 (Materials)	Cold Plated Brass
接線形式 (Connections) :	
壓接 Press	: 8VC 8W2C 8W3C 8W4C : 25W1C 25W2C 25W3C 25W4C 25W5C
銲接 Solder	: 8VS 8W2S 8W3S 8W4S : 25W1S 25W2S 25W3S 25W4S 25W5S
繞接 Wire Wrap	: 8V-2 8W2-2 8W3-2 8W4-2 : 25W1-2 25W2-2 25W3-2 25W4-2 25W5-2
端子 Terminal	: 25W1T 25W2T 25W3T 25W4T 25W5T

單位 : m/m DIMENSION IN MILLIMETER

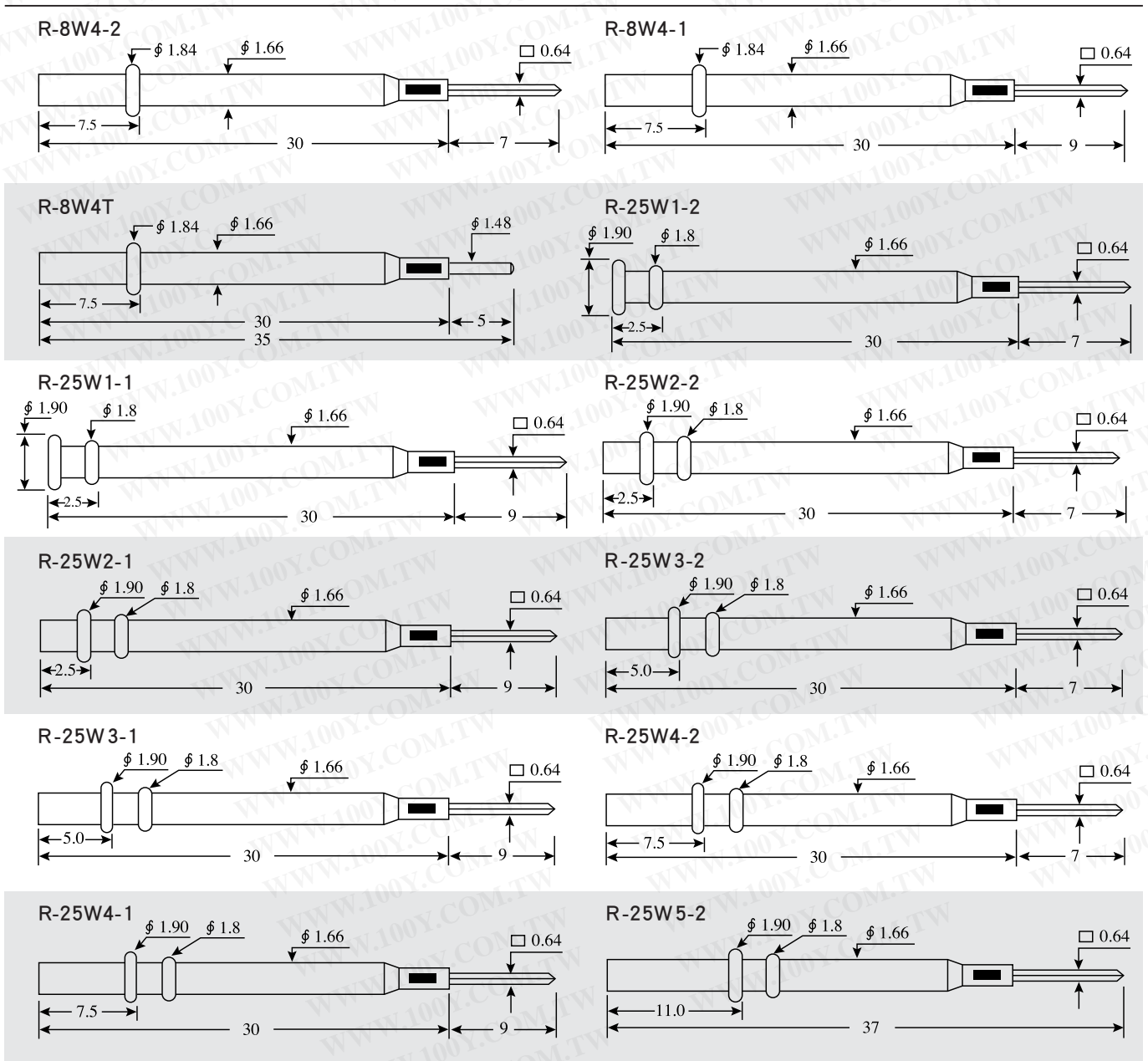

25# PRECISION RECEPTACLES

勝特力材料 886-3-5753170
 勝特力电子(上海) 86-21-34970699
 勝特力电子(深圳) 86-755-83298787
[Http://www.100y.com.tw](http://www.100y.com.tw)

最小間距 (Recommended Min Center)	2.54m/m
鑽孔尺寸 (Drill Size)	1.7m/m ; 1.75m/m
材質 (Materials)	Cold Plated Brass
接線形式 (Connections) :	
壓接 Press	: 8VC 8W2C 8W3C 8W4C : 25W1C 25W2C 25W3C 25W4C 25W5C
銲接 Solder	: 8VS 8W2S 8W3S 8W4S : 25W1S 25W2S 25W3S 25W4S 25W5S
繞接 Wire Wrap	: 8V-2 8W2-2 8W3-2 8W4-2 : 25W1-2 25W2-2 25W3-2 25W4-2 25W5-2
端子 Terminal	: 25W1T 25W2T 25W3T 25W4T 25W5T

單位 : m/m DIMENSION IN MILLIMETER

