

T-2 BARE BOARD PROBE

勝特力材料 886-3-5753170
 勝特力电子(上海) 86-21-54151736
 勝特力电子(深圳) 86-755-83298787
[Http://www.100y.com.tw](http://www.100y.com.tw)

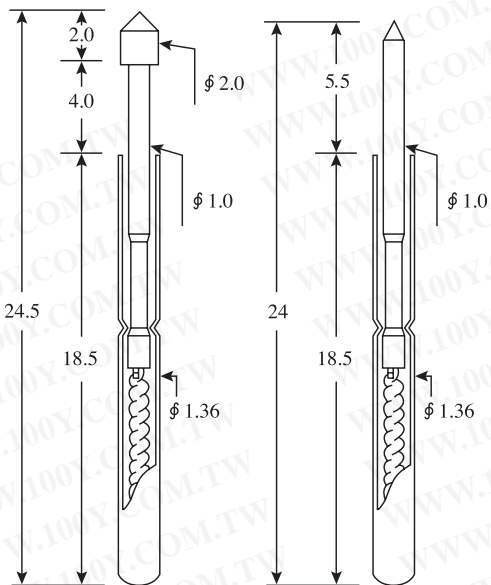

| | |
|-------------------------------|---|
| 最小間距 (Recommended Min Center) | 2.54m/m |
| 鑽孔尺寸 (Drill Size) | 1.7m/m 1.75m/m |
| 材質 (Materials) | PLUNGER:RH.PLATED BE CU BARREL:AU.PLATED BRASS |
| 行程 (Full Travel) | 2.54m/m |
| 全壓彈力 (Spring Pressure) | 60g, 100g, 150g, 200g, 250g |
| 額定電流 (Current Rating) | 3A |
| 接觸電阻 (Contact Resistance) | 50mΩ |

單位 : m/m DIMENSION IN MILLIMETER

★ : 訂製品

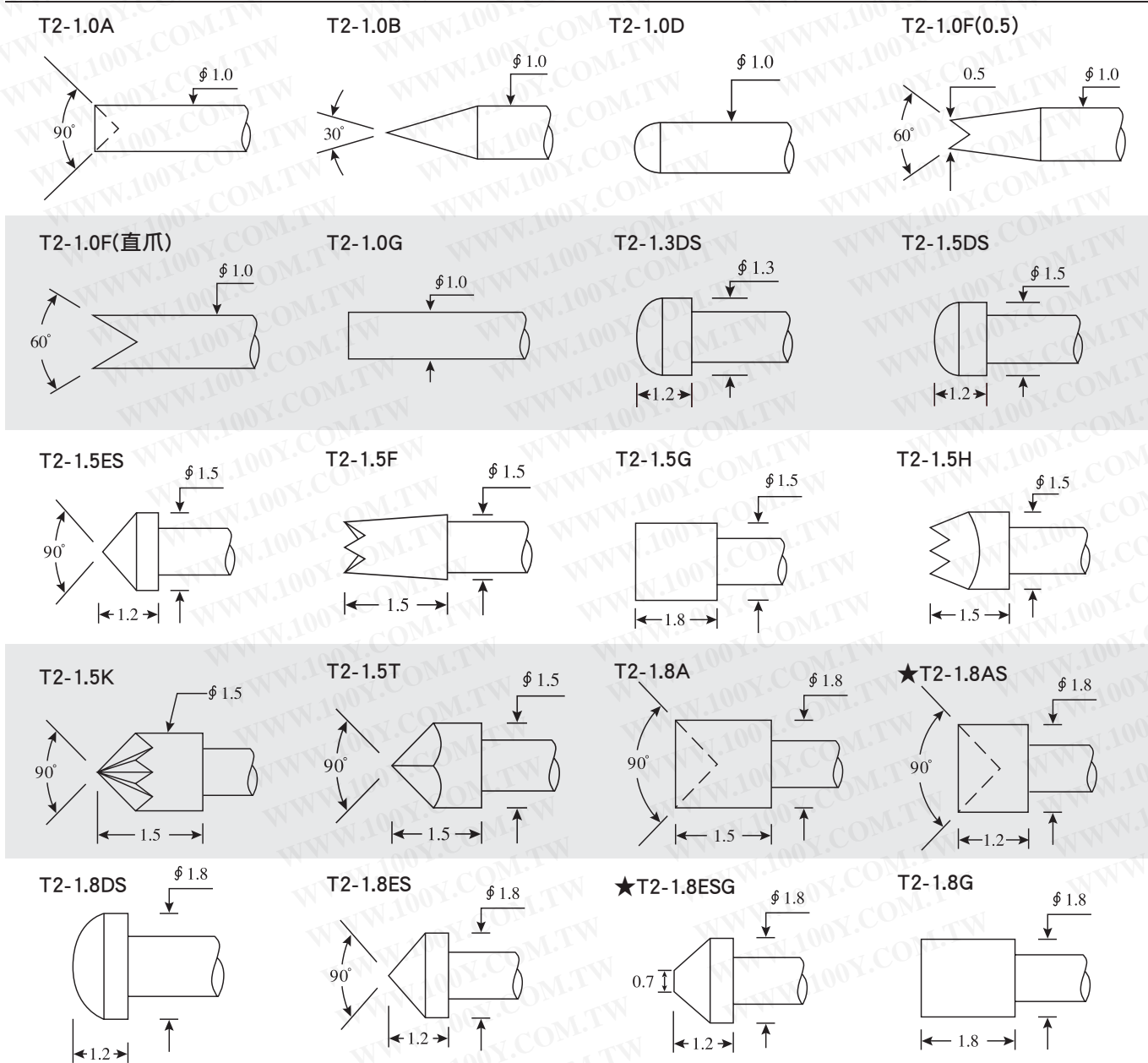

T-2 BARE BOARD PROBE

勝特力材料 886-3-5753170
 勝特力电子(上海) 86-21-54151736
 勝特力电子(深圳) 86-755-83298787
[Http://www.100y.com.tw](http://www.100y.com.tw)

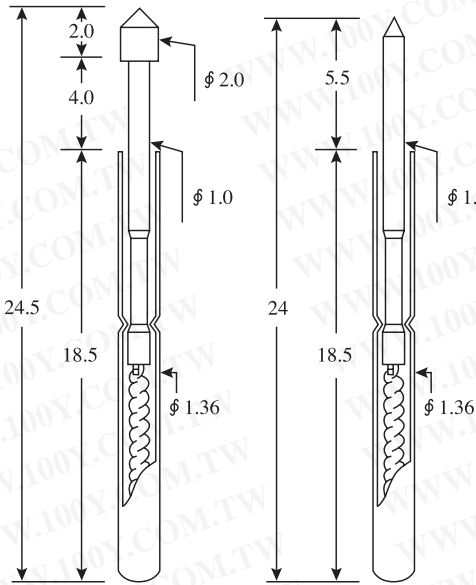

| | |
|-------------------------------|---|
| 最小間距 (Recommended Min Center) | 2.54m/m |
| 鑽孔尺寸 (Drill Size) | 1.7m/m 1.75m/m |
| 材質 (Materials) | PLUNGER:RH.PLATED BE CU BARREL:AU.PLATED BRASS |
| 行程 (Full Travel) | 2.54m/m |
| 全壓彈力 (Spring Pressure) | 60g, 100g, 150g, 200g, 250g |
| 額定電流 (Current Rating) | 3A |
| 接觸電阻 (Contact Resistance) | 50mΩ |

單位 : m/m DIMENSION IN MILLIMETER

★ : 訂製品

T2-1.8H

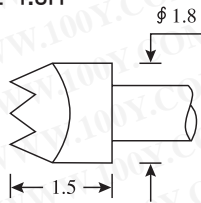

T2-1.8K

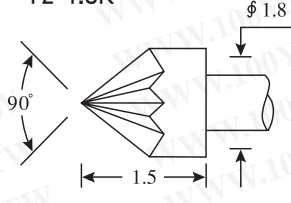

T2-1.8T

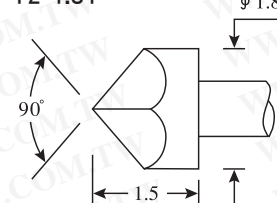

T2-2.0ES

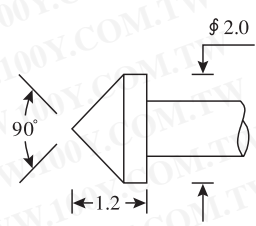

T2-2.0K

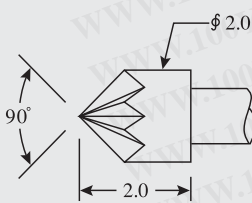

★T2-2.5D

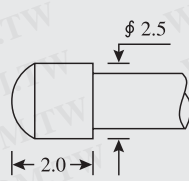

T2-2.5ES

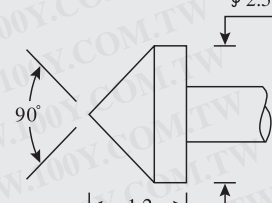

T2-2.5ESG

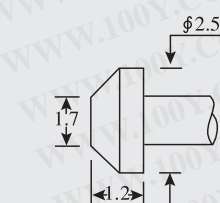

T2-2.5K

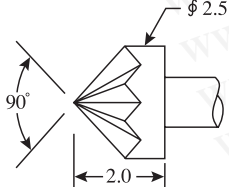

T2-3.0ES

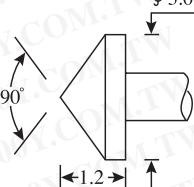

T2-3.0ESG

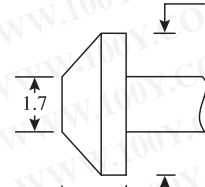

T2-3.0K

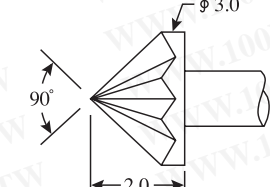

T2-4.0ES

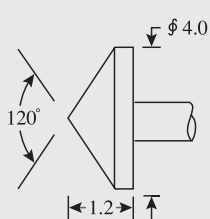

T2-4.0ESG

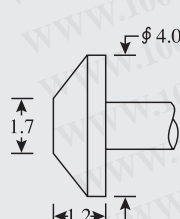

T2-4.0K

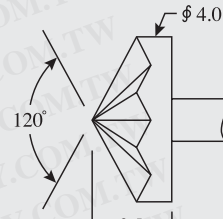

T2-1.5HL

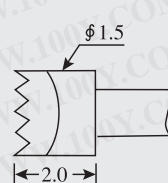

T2-2.5HL

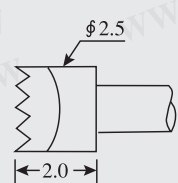

All specifications subject to change without notice.

2# PRECISION RECEPTACLES

勝特力材料 886-3-5753170
 勝特力电子(上海) 86-21-54151736
 勝特力电子(深圳) 86-755-83298787
[Http://www.100y.com.tw](http://www.100y.com.tw)

| | |
|-------------------------------|--------------------|
| 最小間距 (Recommended Min Center) | 2.54m/m |
| 鑽孔尺寸 (Drill Size) | 1.7m/m 1.75m/m |
| 材質 (Materials) | Cold Plated Brass |
| 接線形式 (Connections) | |
| 壓接.....Press | : 2VC 2W1C 2W2C |
| 銲接.....Solder | : 2VS 2W1S 2W2S |
| 繞接.....Wire Wrap | : 2V-2 2W1-2 2W2-2 |

單位 : m/m DIMENSION IN MILLIMETER

R-2VC

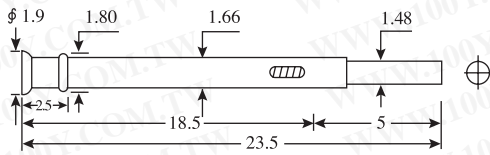

R-2V-1

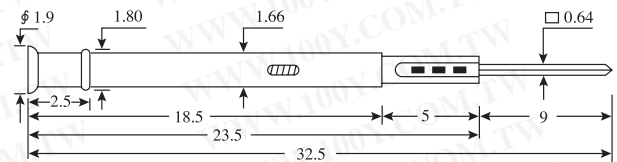

R-2VS

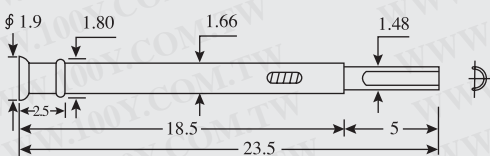

R-2W1-1

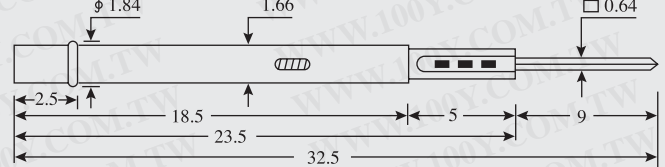

R-2W1C

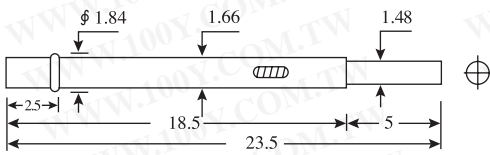

R-2W2-1

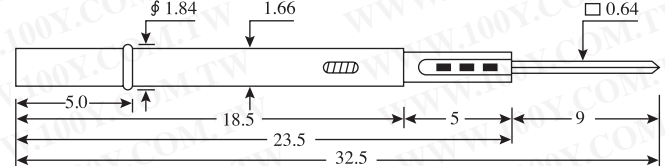

R-2W1S

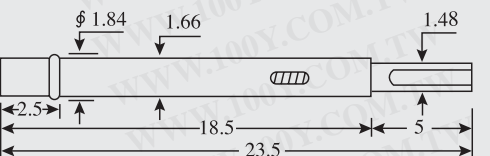

R-2V-2

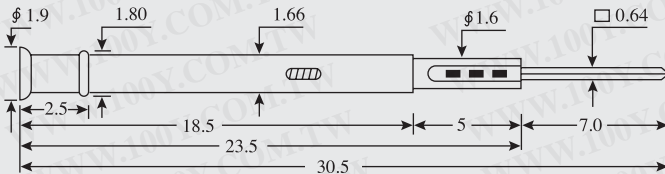

R-2W2C

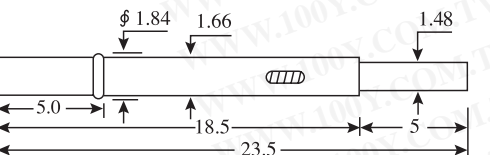

R-2W1-2

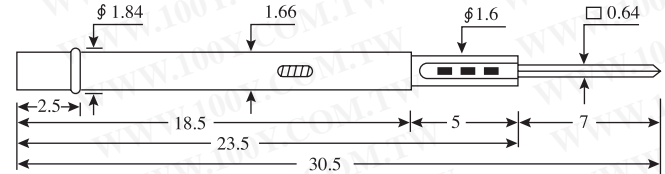

R-2W2S

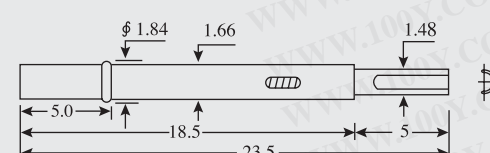

R-2W2-2

