

## 規格書 | 產品型號: 221-415

COMPACT Splicing Connector; for all conductor types; max. 4 mm<sup>2</sup>; 5-conductor; with levers; transparent housing; Surrounding air temperature: max 85°C (T85); 4,00 mm<sup>2</sup>; transparent

[www.wago.com/221-415](http://www.wago.com/221-415)

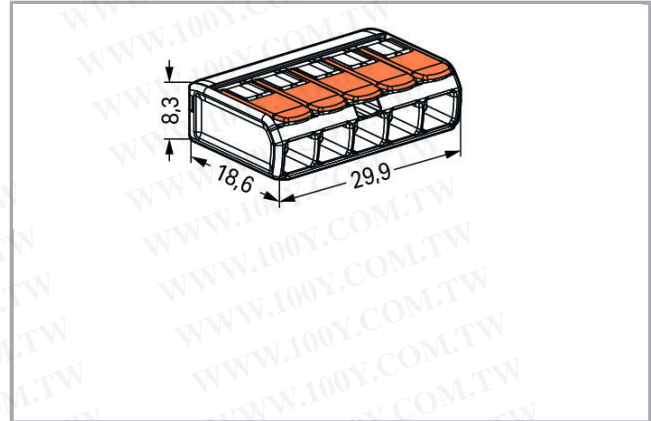

RoHS  Compliant [BOMcheck.net](https://www.bomcheck.net)



勝特力材料 886-3-5753170  
勝特力电子(上海) 86-21-34970699  
勝特力电子(深圳) 86-755-83298787  
[Http://www.100y.com.tw](http://www.100y.com.tw)

### 產品描述

Your Benefits:

- Easy to use: Pull the lever up, insert a conductor and push the lever back down
- Available as 2-, 3- and 5-wire connectors
- Easily terminate conductors from 0.14 to 4 mm<sup>2</sup>, as well as solid and stranded conductors from 0.2 to 4 mm<sup>2</sup> (24 ... 12 AWG).
- Time savings for installers and device manufacturers.



- Quickly install devices with higher levels of power consumption.
- Safely install long cable runs with larger conductor cross sections.
- Mounting carrier for installation conforming to standards
- Custom carriers are possible

## 安全資訊 1:

## 資料

## 電氣資料

## Ratings per IEC/EN 60664-1

額定電壓 (II / 2)	450 V
額定脈衝電壓 (II / 2)	4 kV
額定電流	32 A
圖例 (額定值)	(II / 2) $\triangleq$ Overvoltage category II / Pollution degree 2

## Approvals per UL 1059

額定電壓 UL (使用組 C)	600 V
額定電流 UL (用途組 C)	20 A
認證	UL 486C

## 連接資料

連接技術	CAGE CLAMP®
操作類型	操作桿
可連接導線材料	銅
額定截面積	4 mm <sup>2</sup>
單芯導線	0.2 ... 4 mm <sup>2</sup> / 24 ... 12 AWG
多芯導線	0.2 ... 4 mm <sup>2</sup> / 24 ... 12 AWG
細多芯導線	0.14 ... 4 mm <sup>2</sup> / 24 ... 12 AWG
剝線長度	11 mm / 0.43 英寸
總連接點數	5
總電位數	1
接線類型	側面接線

如有變更，恕不另行通知。

WAGO Contact, Ltd  
5F., No.168, Jianshang Rd  
Zhonghe City | Taipei County 23585, Taiwan  
Tel.: +886 2 22259755 | Fax: +886 2 22251511  
Email: info.taiwan@wago.com

您有關於產品的任何問題嗎？  
我們非常樂意接聽您的來電，+886 2 22250123。

## 幾何數據

寬度	29.9 mm / 1.177 inch
高度	8.3 mm / 0.327 inch
深度	18.6 mm / 0.732 inch

## 材料資料

顏色	透明
可燃性等級依照 UL 94	V2
重量	4 g

## 環境條件

(工作) 環境溫度	85 °C
Continuous operating temperature	105 °C
T-Marking per EN 60998	T85

## 商業資料

Product Group	7 (Push Wire Conn.)
包裝類型	BOX
Country of origin	DE
GTIN	4055143234658
Customs Tariff No.	85369010000



## 認證 / 證書

## Country specific Approvals

標誌	認證	其他認證資訊	認證名稱
	CCA DEKRA Certification B.V.	EN 60998	NTR NL- 7642
	CCA DEKRA Certification B.V.	EN 60998	71- 101731

## Ship Approvals

標誌	認證	其他認證資訊	認證名稱

	<b>ABS</b> American Bureau of Shipping	-	18- HG1755093- PDA
	<b>DNV GL</b> Det Norske Veritas, Germanischer Lloyd	EN 60998	TAE000015T
	<b>LR</b> Lloyds Register	EN 60998	04/20013 (E8)

## UL-Approvals

標誌	認證	其他認證資訊	認證名稱
	<b>UL</b> Underwriters Laboratories Inc.	UL 467	E201573
	<b>UL</b> Underwriters Laboratories Inc.	UL 486C	E69654

## 相容產品

## Mounting adapter

	<b>產品編號: 221-500</b> Mounting carrier; 221 Series - 4 mm <sup>2</sup> ; for DIN-35 rail mounting/screw mounting; orange	<a href="http://www.wago.com/221-500">www.wago.com/221-500</a>
	<b>產品編號: 221-500/000-006</b> Mounting carrier; 221 Series - 4 mm <sup>2</sup> ; for DIN-35 rail mounting/screw mounting; blue	<a href="http://www.wago.com/221-500/000-006">www.wago.com/221-500/000-006</a>
	<b>產品編號: 221-500/000-053</b> Mounting carrier; 221 Series - 4 mm <sup>2</sup> ; for DIN-35 rail mounting/screw mounting; dark gray-yellow	<a href="http://www.wago.com/221-500/000-053">www.wago.com/221-500/000-053</a>
	<b>產品編號: 221-505</b> Mounting carrier; for 5-conductor terminal blocks; 221 Series - 4 mm <sup>2</sup> ; for screw mounting; white	<a href="http://www.wago.com/221-505">www.wago.com/221-505</a>
	<b>產品編號: 221-505/000-004</b> 安裝支架; 適用於 5 線接線端子台; 221 系列 - 4 mm <sup>2</sup> ; 用於螺絲安裝; 黑色	<a href="http://www.wago.com/221-505/000-004">www.wago.com/221-505/000-004</a>

	<p><b>產品編號: 221-515</b>                  Mounting carrier; for 5-conductor terminal blocks; 221 Series - 4 mm<sup>2</sup>; with snap-in mounting foot for horizontal mounting; white</p>	<a href="http://www.wago.com/221-515">www.wago.com/221-515</a>
	<p><b>產品編號: 221-515/000-004</b>                  安裝支架; 適用於 5 線接線端子台; 221 系列 - 4 mm<sup>2</sup>; 帶有用於水平安裝的固定銷釘; 黑色</p>	<a href="http://www.wago.com/221-515/000-004">www.wago.com/221-515/000-004</a>
	<p><b>產品編號: 221-525</b>                  安裝支架; 適用於 5 線接線端子台; 221 系列 - 4 mm<sup>2</sup>; 帶有用於水平安裝的固定銷釘; 白色</p>	<a href="http://www.wago.com/221-525">www.wago.com/221-525</a>
	<p><b>產品編號: 221-525/000-004</b>                  Mounting carrier; for 5-conductor terminal blocks; 221 Series - 4 mm<sup>2</sup>; with snap-in mounting foot for vertical mounting; black</p>	<a href="http://www.wago.com/221-525/000-004">www.wago.com/221-525/000-004</a>

**下載**

**Documentation**

**Additional Information**

Technical explanations	2019/4/3	pdf 2.1 MB	<a href="#">下載</a>
------------------------	----------	---------------	--------------------

**CAD/CAE-Data**

**CAD data**

2D/3D Models 221-415	<a href="#">URL</a>	<a href="#">下載</a>
----------------------	---------------------	--------------------

**CAE data**

EPLAN Data Portal 221-415	<a href="#">下載</a>
---------------------------	--------------------

**Installation Notes**

**Inserting a conductor**

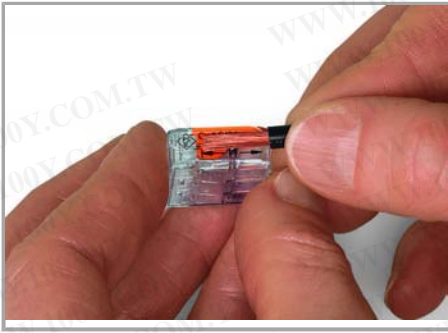

Strip conductor to 11 mm (0.43 inch).

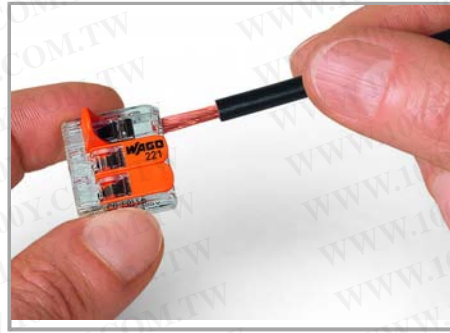

Termination: Lift the lever to open the clamping unit and insert a stripped conductor.

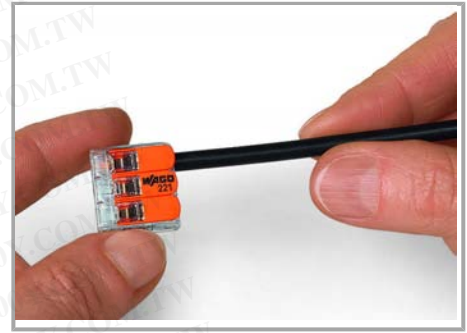

Then, lower the lever to close the clamp.

### Application

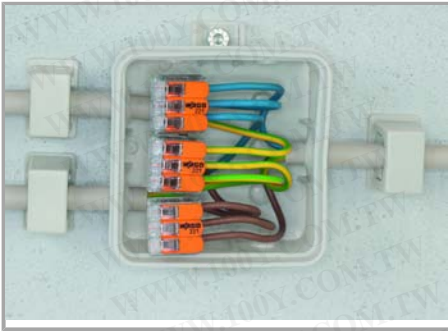

Wiring fine-stranded conductors in a junction box.



Custom low-voltage lighting system



Lighting distribution in ceiling canopy



Pendant light connection in suspended ceilings



COMPACT Splicing Connectors for All  
Conductor Types, 4 mm<sup>2</sup> (12 AWG), 221  
Series



**Compact, lever-operated splicing connectors:**

Tool-free connection of up to five stripped, fine-stranded conductors from 0.14 ... 4 mm<sup>2</sup>, as well as solid or stranded conductors from 0.2 ... 4 mm<sup>2</sup> (24 ... 12 AWG).

**How these work:**

Pull up one of the orange operating levers to open the clamping unit. Then insert the conductor and push the lever back down, flush with the connector housing.

**Safety:**

The specially designed rest position of the lever reliably prevents accidental unclamping of a connected conductor.

Application safety, for any type of conductor (solid, stranded, fine-stranded), is confirmed by approvals like ENEC or UL.

勝特力材料 886-3-5753170  
勝特力电子(上海) 86-21-34970699  
勝特力电子(深圳) 86-755-83298787  
[Http://www.100y.com.tw](http://www.100y.com.tw)