

PRODUCT NUMBER

71600-YXXLF

LEAD FREE, SEE NOTE 6 & 7.

TOTAL NB OF POSITION 04 TO 64  
SEE SHEET 2

OPTIONAL STRAIN RELIEF  
SEE SHEET 2

勝特力電材超市-龍山店 886-3-5773766  
勝特力電材超市-光復店 886-3-5729570  
勝特力電子(上海) 86-21-34970699  
勝特力電子(深圳) 86-755-83298787  
<http://www.100y.com.tw>

TRIANGLE INDICATES  
POSITION 1  
NOTE 5

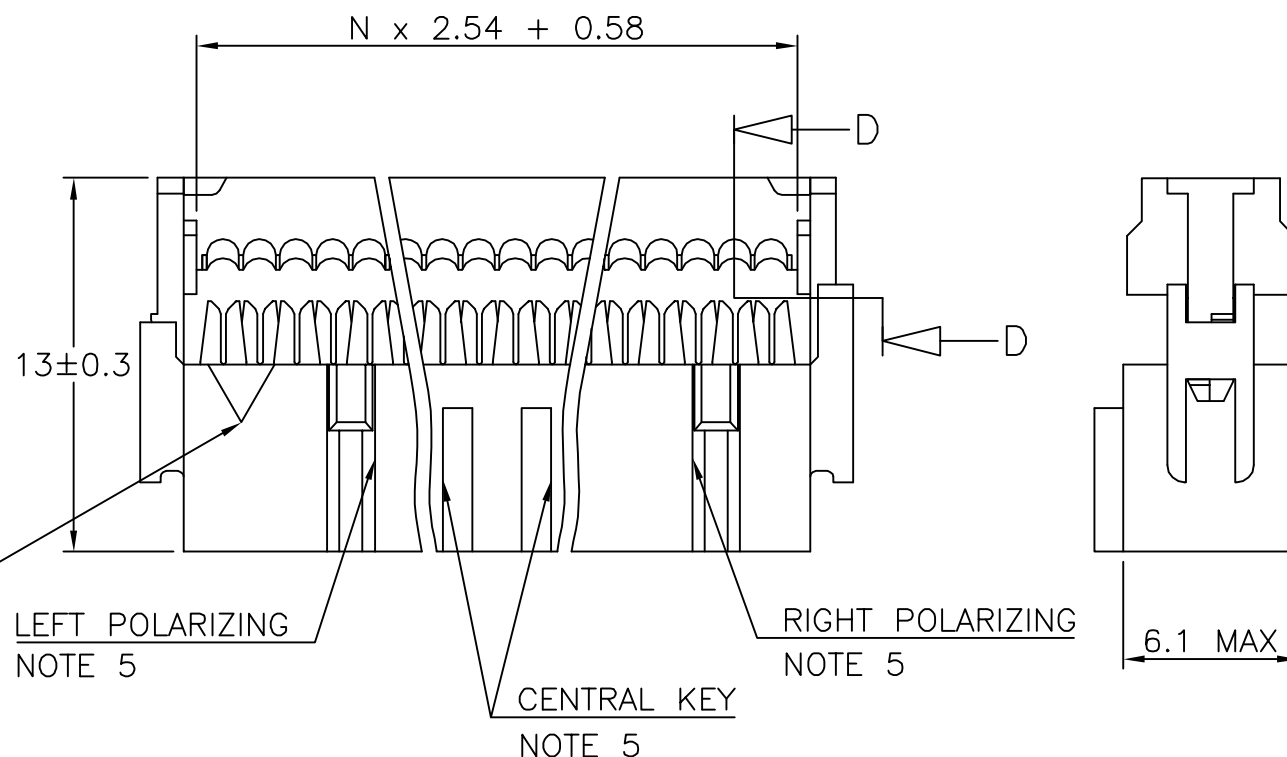

NOTES:

- 1 - PLASTIC MAT'L : GLASS FILLED HIGH TEMPERATURE THERMOPLASTIC. UL94V-0 COLOR: GREY
- 2 - PIN MATERIAL : PHOSPHOR BRONZE
- 3 - PRODUCT PACKAGED IN TUBES.
- 4 - TO DETERMINE DIMENSIONS :  
N = NUMBER OF POSITIONS  
EXAMPLE : 8 POS  $N \times 2.54 = 20.32\text{mm}$
- 5 - 2x5, 2x6, 2x7 HAVE NO LEFT POLARIZING SLOT.  
- 2x2, 2x3 WITH CENTRAL KEY HAVE NO TRIANGLE, NO LEFT AND RIGHT POLARIZING SLOT.  
- 2x2 WITHOUT CENTRAL KEY HAS NO LEFT AND RIGHT POLARIZING SLOT.  
- 2x3, 2x4 WITHOUT CENTRAL KEY HAVE NO LEFT POLARIZING SLOT  
- 2x4 WITH CENTRAL KEY HAVE NO LEFT AND RIGHT POLARIZING SLOT
- 6 - 71600-XXXLF IS SIMILAR TO 71600-XXX, THE SUFFIX 'LF' IS ADDED FOR LEAD FREE IDENTIFICATION.
- 7 - THIS PRODUCT MEETS EUROPEAN UNION DIRECTIVES AND OTHER COUNTRY REGULATIONS AS PER GS-22-008.  
PACKAGING SPECIFICATION AS PER GS-14-920.

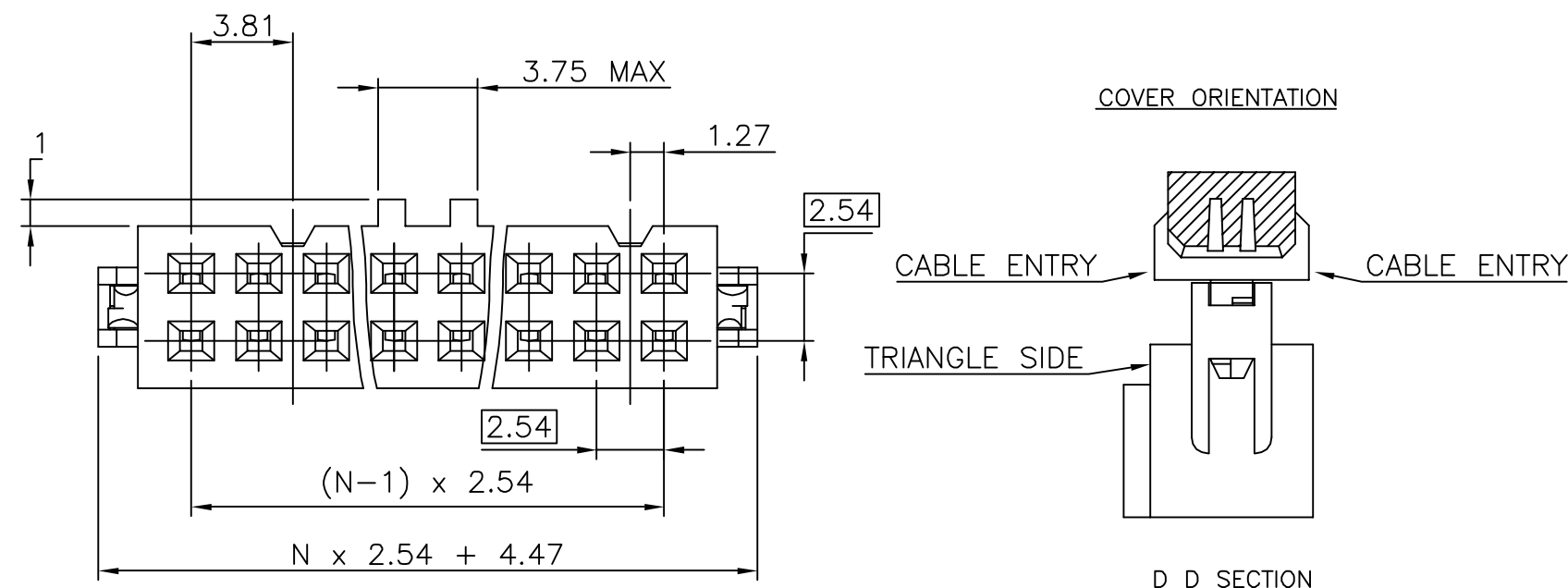

mat'l. code SEE NOTES				tolerances unless otherwise specified			CUSTOMER COPY	<b>ELECTRONICS</b> www.fciconnect.com	
ltr	ecr no	dr	date	linear	x.x ±0.3		projection	title QUICKIE III FEM	
AG	F04-0330	LMU	04.09.01		x.xx ±0.13			0.76µm Au	
AH	F05-0109	JCO	05.01.17	angles	x.xxx ±0.05			product family 2.54MM IDC	
AJ	F05-0171	LMU	05.04.07		dr			code	
AK	F05-0180	LMU	05.04.22	enr		size		213	
AE	F03019	DLE	03.01.23	chr		scale		sheet	
AF	F04-0168	LMU	04.04.08	appd		5:1		1 of 2	
sheet	revision	AK	AC						
index	sheet	1	2						

Tous droits réservés. Toute réimpression, reproduction ou utilisation non autorisée sans la permission écrite de la FCI est formellement interdite.  
 All rights reserved. Any reprinting or unauthorized use without the written permission of FCI is expressly prohibited.  
 Copyright FCI Intercon S.A.



All rights reserved. Reproduction or use in any form without the written authority from the proprietor is prohibited.  
 Copyright FCI Intercon S.A.

CORE RANGE	
STRAIN RELIEF	Nbr OF POSITIONS
0/1	04
0/1	06
0/1	08
0/1	10
0/1	14
0/1	16
0/1	18
0/1	20
0/1	24
0/1	26
0/1	30
0/1	34
0/1	40
0/1	50
0/1	60
0/1	64

PLATING	
0.76µm GOLD ON CONTACT AREA	
1.27 µm Ni REMAINDER OF PRODUCT	

CATALOGUE RANGE	
STRAIN RELIEF	Nbr OF POSITIONS
2/6	04
2/6	06
2/6	08
2/6	10
2/6	14
2/6	16
2/6	18
2/6	20
2/6	24
2/6	26
2/6	30
2/6	34
2/6	40
2/6	50
2/6	60
2/6	64

  

PLATING	
0.76µm GOLD ON CONTACT AREA	
1.27 µm Ni REMAINDER OF PRODUCT	

624
304
204 / 224
004
DASHES NOT AVAILABLE

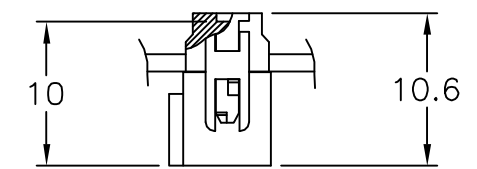

WITHOUT STRAIN RELIEF

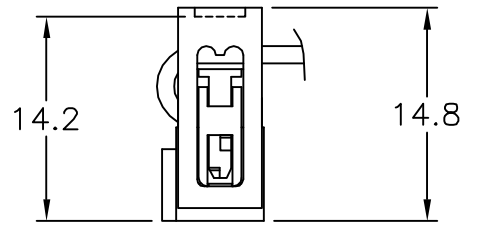

WITH LOW PROFILE STRAIN RELIEF

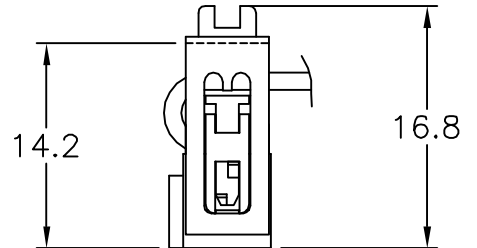

WITH STANDARD STRAIN RELIEF

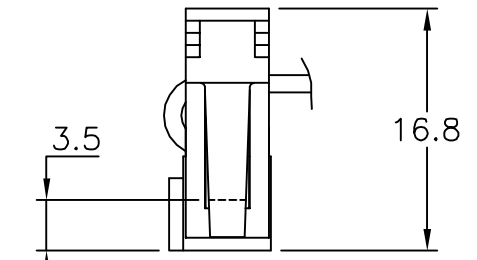

WITH LATCHING STRAIN RELIEF

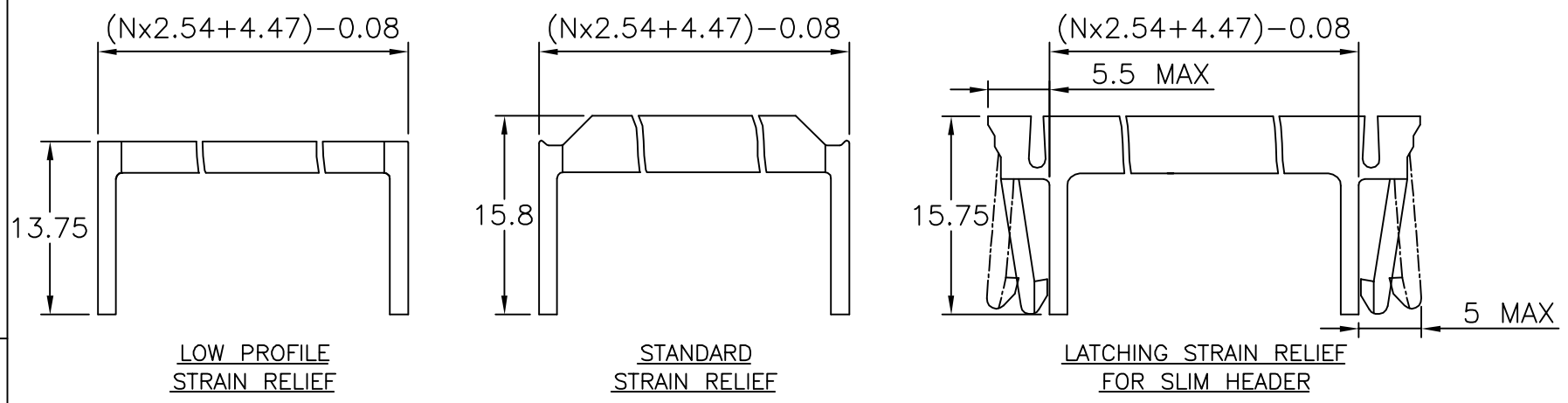

LOW PROFILE STRAIN RELIEF

STANDARD STRAIN RELIEF

LATCHING STRAIN RELIEF FOR SLIM HEADER

71600-6YY	●					●
71600-3YY		●	●			
71600-2YY	●			●		
71600-1YY	●				●	
71600-0YY	●		●			
PRODUCT NUMBER	WITH CENTRAL KEY	WITHOUT CENTRAL KEY	STANDARD STRAIN RELIEF	WITHOUT STRAIN RELIEF	LOW PROFILE STRAIN RELIEF	LATCHING STRAIN RELIEF

mat'l. code				tolerances unless otherwise specified			CUSTOMER COPY		<b>ELECTRONICS</b> www.fciconnect.com		
ltr	ecn no	dr	date	linear	angles	D.LE	01.01.24	projection	title		
X	F70666	AAN	97.11.05						IDC RECEPT DR		
Y	F10121	DLE	01.01.24	engr	chr	P.NZ	01.01.24		product family		
AA	F10199	GCO	01.04.26						QUICKIE		
AB	F03019	DLE	03.01.23	appd	P.NZ	01.01.24	01.01.24	mm	code		
AC	F05-0180	LMU	05.04.22						213		
sheet index		revision sheet		scale		N/A		size		sheet	
				A3		71600		2 of -			