

| REVISIONS | | | | | |
|-----------|-----|-------------|-----------|---------|------|
| REV | ECO | DESCRIPTION | DATE | BY | APPR |
| A1 | -- | RELEASED | 16MAR2020 | J. HEAD | DH |

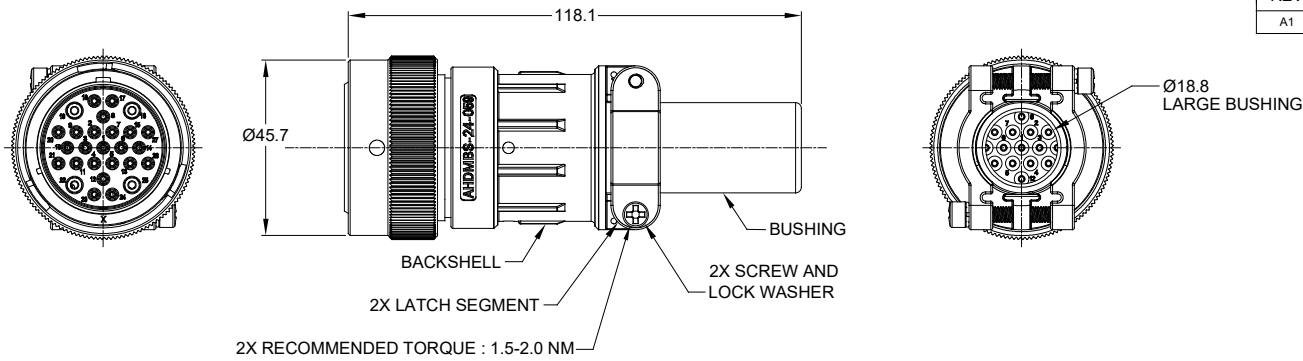

NOTES: UNLESS OTHERWISE SPECIFIED

- PLUG MATERIAL:
 SHELL: ZINC ALLOY, NICKEL PLATED
 COUPLING RING: ALUMINUM ALLOY, NICKEL PLATED
 INSERT AND RETAINING RING: THERMOPLASTIC
 SEAL: SILICONE RUBBER
- BACKSHELL MATERIAL:
 SHELL: ALUMINIUM ALLOY, NICKEL PLATED;
 LATCH SEGMENT: ALUMINIUM ALLOY, NICKEL PLATED;
 SCREW AND LOCK WASHER: STAINLESS STEEL;
 BUSHING: EPDM.
- SPECIFICATIONS:
 3.1 OPERATING TEMPERATURE: -55°C TO +125°C.
 3.2 DIELECTRIC WITHSTANDING VOLTAGE: LESS THAN 2 MILLIAMPS CURRENT LEAKAGE @ 1500 VOLTS AC.
 3.3 INSULATION RESISTANCE: 1000 MEGOHM MIN @ 25°C.
 3.4 MOISTURE RESISTANCE: IP67 & IP69K (MATED CONDITION).
 3.5 MATING CYCLE DURABILITY: 100 CYCLES
 3.6 RoHS COMPLIANT
- APPLY TO CABLE OD SIZE: Ø11.20-Ø24.08 . CAN BE USED:
 4.1. WITH LARGE AND SMALL BUSHINGS IN PLACE.
 4.2. WITH ONLY LARGE BUSHING IN PLACE.
 4.3. WITH BOTH BUSHINGS REMOVED.
- ALL DIMENSIONS ARE FOR REFERENCE USE ONLY.
- SEE SPECIFIC PLUG DRAWING FOR:
 6.1 CONTACT SIZE AND WIRE RANGE.
 6.2 RETAINING RING COLOR.
 6.3 MATING PART(S).
 6.4 CONTACT LAYOUT AND ALL OTHER SPECIFICATIONS.

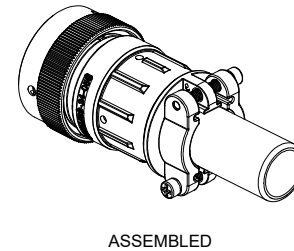

ASSEMBLED

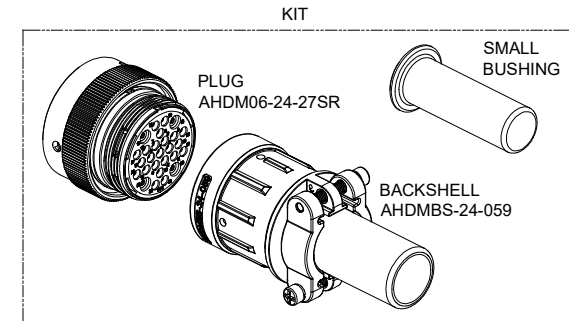

| | | | |
|---------------------------------------|-----------------|--|--|
| AHDM06-24-27SR-059 | | HD36-24-27SE-059 | |
| PART NUMBER | | DESCRIPTION | |
| QUANTITY | | ITEM | |
| MATERIALS LIST | | | |
| UNLESS OTHERWISE SPECIFIED | | | |
| 1) All dimensions are in metric (mm). | | | |
| 2) Tolerances are as follows: | | | |
| 1 PL DEC ±0.30 | Fractions ±1/64 | | |
| 2 PL DEC ±0.15 | Angles ±1° | | |
| 3 PL DEC ±0.08 | | | |
| 3) Note reference = | | | |
| SIGNATURES | | DATE | |
| DRAWN: J. HEAD | | 16MAR2020 | |
| CHECKED: | | | |
| ENGINEER: | | | |
| APPROVAL: | | | |
| MATERIAL SPECIFICATIONS: | | CUSTOMER: | |
| PROCESS SPECIFICATIONS: | | THIS DRAWING IS SUPPLIED FOR INFORMATION ONLY. DESIGN FEATURES, SPECIFICATIONS AND PERFORMANCE DATA SHOWN HEREON ARE THE PROPERTY OF THE AMPHENOL CORPORATION. NO RIGHTS OF REPRODUCTION ARE IMPLIED. ALL DIMENSIONS ARE SUBJECT TO NORMAL MANUFACTURING VARIATIONS. | |
| NEXT ASSY: | | SCALE: NONE | |
| | | SHEET 1 OF 1 | |

Amphenol

Sine Systems - www.amphenol-sine.com
 44724 Morley Drive
 Clinton Township, MI 48036

DURAMATE AHDM PLUG, SIZE 24, WD THD,
 KIT W/ CABLE CLAMP BACKSHELL

SIZE: **B** TYPE: **C-** DWG NO: **AHDM06-24-27SR-059** REVISION: **A1**

TITLE: KIT, PLUG AND BACKSHELL, SZ 24
 DWG NO: AHDM06-24-27SR-059
 REV: A1
 SH: 1
 OF: 1



AT Series™ - Contact Size 16 Options

| Machined Contacts, Sockets & Pins | | | | |
|-----------------------------------|--|------|-------|----------|
| Part Number | Description | Size | AWG | Type |
| AT60-215-1631 | Male Contact - Pin, Gold-plated | 16 | 14 | Machined |
| AT62-209-1631 | Female Contact - Socket, Gold-plated | 16 | 14 | Machined |
| AT60-215-16141 | Male Contact - Pin, Nickel-plated | 16 | 14 | Machined |
| AT62-209-16141 | Female Contact - Socket, Nickel-plated | 16 | 14 | Machined |
| AT60-202-1631 | Male Contact - Pin, Gold-plated | 16 | 16-20 | Machined |
| AT62-201-1631 | Female Contact - Socket, Gold-plated | 16 | 16-20 | Machined |
| AT60-202-16141 | Male Contact - Pin, Nickel-plated | 16 | 16-20 | Machined |
| AT62-201-16141 | Female Contact - Socket, Nickel-plated | 16 | 16-20 | Machined |
| AT60-202-1631-22 | Male Contact - Pin, Gold-plated | 16 | 22-24 | Machined |
| AT62-201-1631-22 | Female Contact - Socket, Gold-plated | 16 | 22-24 | Machined |
| AT60-202-16141-22 | Male Contact - Pin, Nickel-plated | 16 | 22-24 | Machined |
| AT62-201-16141-22 | Female Contact - Socket, Nickel-plated | 16 | 22-24 | Machined |

| Tooling - Machined Contacts | | |
|---|-------------|---|
| Part | Part Number | Description |
|  | CA-5D12 | Universal Hand Crimp Tool, Size 12/16/20 (Machined contacts only) |
|  | CA-5E12 | Pneumatic Crimp Tool, Size 12/16/20 (Machined contacts only) |

| Contact Removal Tools | | |
|---|---------------|---|
| Part | Part Number | Description |
|  | ATRT-100 | Used for removal of contacts for A Series™ products |
|  | AT11-310-1605 | Contact Removal Tool, Plastic, Size 16 |
|  | A114017 | Sealing Plug, Size 16, White |

| Stamped & Formed Contacts, Sockets & Pins | | | | |
|---|--|------|-------|------------------|
| Part Number | Description | Size | AWG | Type |
| AT60-14-0144 | Male Contact - Pin, Gold-plated | 16 | 14-16 | Stamped & Formed |
| AT62-14-0144 | Female Contact - Socket, Gold-plated | 16 | 14-16 | Stamped & Formed |
| AT60-14-0122 | Male Contact - Pin, Nickel-plated | 16 | 14-16 | Stamped & Formed |
| AT62-14-0122 | Female Contact - Socket, Nickel-plated | 16 | 14-16 | Stamped & Formed |
| AT60-16-0144 | Male Contact - Pin, Gold-plated | 16 | 16-18 | Stamped & Formed |
| AT62-16-0144 | Female Contact - Socket, Gold-plated | 16 | 16-18 | Stamped & Formed |
| AT60-16-0122 | Male Contact - Pin, Nickel-plated | 16 | 16-18 | Stamped & Formed |
| AT62-16-0122 | Female Contact - Socket, Nickel-plated | 16 | 16-18 | Stamped & Formed |
| AT60-16-0644 | Male Contact - Pin, Gold-plated | 16 | 18-20 | Stamped & Formed |
| AT62-16-0644 | Female Contact - Socket, Gold-plated | 16 | 18-20 | Stamped & Formed |
| AT60-16-0622 | Male Contact - Pin, Nickel-plated | 16 | 18-20 | Stamped & Formed |
| AT62-16-0622 | Female Contact - Socket, Nickel-plated | 16 | 18-20 | Stamped & Formed |
| AT60-16-0844 | Male Contact - Pin, Gold-plated | 16 | 20-22 | Stamped & Formed |
| AT62-16-0844 | Female Contact - Socket, Gold-plated | 16 | 20-22 | Stamped & Formed |
| AT60-16-0822 | Male Contact - Pin, Nickel-plated | 16 | 20-22 | Stamped & Formed |
| AT62-16-0822 | Female Contact - Socket, Nickel-plated | 16 | 20-22 | Stamped & Formed |



| Tooling - Stamped & Formed Contacts | | |
|---|-------------|---|
| Part | Part Number | Description |
|  | MFX-3950 | Crimp Die - Size 16, 18-20AWG (S&F contacts only) |
| | MFX-3953 | Crimp Die - Size 16, 16-18AWG (S&F contacts only) |
| | MFX-3975 | Crimp Die - Size 16, 14-16AWG (S&F contacts only) |
| | MFX-3990 | Crimp Die - Size 16, 20-22AWG (S&F contacts only) |
|  | ATT-16-00 | Hand Crimp Tool - Size 16, 14-16AWG (S&F contacts only) |
| | ATT-16-01 | Hand Crimp Tool - Size 16, 18-20AWG (S&F contacts only) |
| | ATT-1612-03 | Hand Crimp Tool - Size 16, 20-22AWG (S&F contacts only) |

Amphenol Sine Systems
 44724 Morley Drive
 Clinton Township, MI 48036 USA
www.amphenol-sine.com
 09/2021

ATP Series™ - Contact Size 12 Options



| Machined Contacts, Sockets & Pins | | | | |
|-----------------------------------|--|------|-------|----------|
| Part Number | Description | Size | AWG | Type |
| AT60-204-12141-10 | Male Contact - Pin, Nickel-plated | 12 | 10-12 | Machined |
| AT62-203-12141-10 | Female Contact - Socket, Nickel-plated | 12 | 10-12 | Machined |
| AT60-220-1231 | Male Contact - Pin, Gold-plated | 12 | 12-14 | Machined |
| AT62-210-1231 | Female Contact - Socket, Gold-plated | 12 | 12-14 | Machined |
| AT60-204-12141 | Male Contact - Pin, Nickel-plated | 12 | 12-14 | Machined |
| AT62-203-12141 | Female Contact - Socket, Nickel-plated | 12 | 12-14 | Machined |

| DiagnosticGrade™ Machined Contacts, Sockets & Pins | | | | |
|--|--|------|-----|----------|
| • Smaller AWG for Diagnostic Applications • Gold-plated • Increased Mating Cycles • Cost-effective | | | | |
| Part Number | Description | Size | AWG | Type |
| 65-54749 | Male Contact - DiagnosticGrade™, Pin, Gold-plated | 12 | 20 | Machined |
| AT62-210-1231-1820 | Female Contact - DiagnosticGrade™, Socket, Gold-plated | 12 | 20 | Machined |

| Tooling - Machined Contacts | | |
|---|-------------|---|
| Part | Part Number | Description |
|  | CA-5D12 | Universal Hand Crimp Tool, Size 12/16/20 (Machined contacts only) |
|  | CA-5E12 | Pneumatic Crimp Tool, Size 12/16/20 (Machined contacts only) |

| Contact Removal Tools | | |
|---|---------------|---|
| Part | Part Number | Description |
|  | ATRT-100 | Used for removal of contacts for A Series™ products |
|  | AT11-337-1205 | Contact Removal Tool, Plastic, Size 12 |
|  | A114017 | Sealing Plug, Size 12, White |

| Stamped & Formed Contacts, Sockets & Pins | | | | |
|---|--|------|-------|------------------|
| Part Number | Description | Size | AWG | Type |
| AT60-12-0244 | Male Contact - Pin, Gold-plated | 12 | 10-12 | Stamped & Formed |
| AT62-12-0244 | Female Contact - Socket, Gold-plated | 12 | 10-12 | Stamped & Formed |
| AT60-12-0222 | Male Contact - Pin, Nickel-plated | 12 | 10-12 | Stamped & Formed |
| AT62-12-0222 | Female Contact - Socket, Nickel-plated | 12 | 10-12 | Stamped & Formed |
| AT60-12-0144 | Male Contact - Pin, Gold-plated | 12 | 12-14 | Stamped & Formed |
| AT62-12-0144 | Female Contact - Socket, Gold-plated | 12 | 12-14 | Stamped & Formed |
| AT60-12-0166 | Male Contact - Pin, Nickel-plated | 12 | 12-14 | Stamped & Formed |
| AT62-12-0166 | Female Contact - Socket, Nickel-plated | 12 | 12-14 | Stamped & Formed |

| Tooling - Stamped & Formed Contacts | | |
|---|-------------|---|
| Part | Part Number | Description |
|  | MXF-3973 | Crimp Die - Size 12 (S&F contacts only) |
| | MXF-3985 | Crimp Die - Size 12 (S&F contacts only) 10-12AWG -02XX Series |
|  | ATT-12-00 | Hand Crimp Tool - Size 12, 12AWG (S&F contacts only) |

Amphenol Sine Systems
 44724 Morley Drive
 Clinton Township, MI 48036 USA
www.amphenol-sine.com
 09/2021