

REVISIONS					
REV	ECO	DESCRIPTION	DATE	BY	APPR
A3	-	RELEASE NEW DRAWING FORMAT	02JAN14	JARRY	-
A4	C1403S	UPDATE THE APPEARANCE	16NOV21	LOUIE	TOMMY

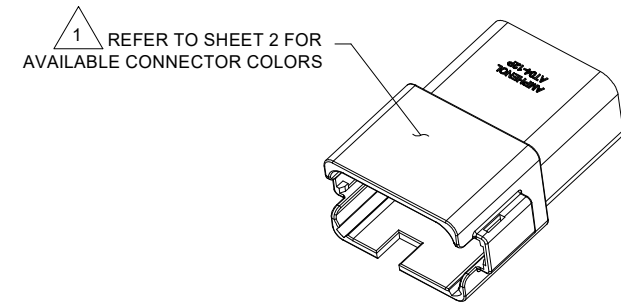
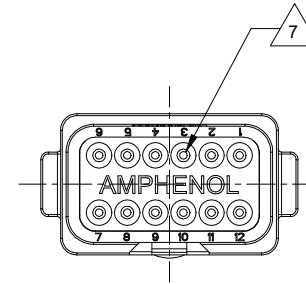
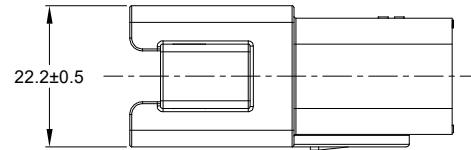
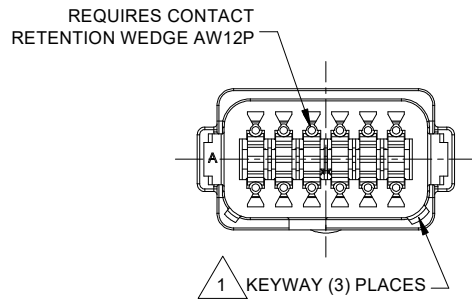
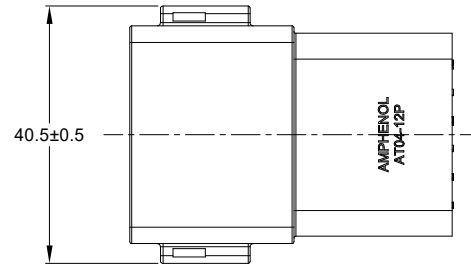

NOTES: UNLESS OTHERWISE SPECIFIED

1 SEE SHEET 2 FOR KEY ARRANGEMENTS AND COLORS.

2. MATERIAL:  
HOUSING: THERMOPLASTIC  
SEAL: SILICONE RUBBER

3. MODIFICATIONS: N/A

4. SPECIFICATIONS:  
4.1 CURRENT RATING: 13 AMPS  
4.2 OPERATING TEMPERATURE: -55°C TO +125°C  
4.3 DIELECTRIC WITHSTANDING VOLTAGE: LESS THAN 2 MILLIAMPS CURRENT LEAKAGE @ 1500 VOLTS AC.  
4.4 INSULATION RESISTANCE: 1000 MEGOHMS MIN @ 25°C.  
4.5 MOISTURE RESISTANCE: IP69K&IP68 ( 1M OF WATER FOR A PERIOD OF 24 HOURS, MATED CONDITION )  
4.6 MATING CYCLE DURABILITY: 100 CYCLES  
4.7 RoHS COMPLIANT

5. MATING PART: AT06-12SX\* PLUG  
( X = A,B,C,D KEYS; \* = MODIFICATIONS AND COLORS )

6. ALL DIMENSIONS ARE FOR REFERENCE USE ONLY.

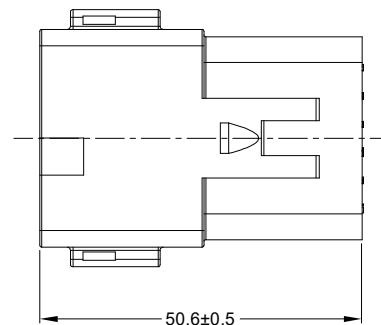

7 CONTACT SIZE AND REAR SEAL WIRE RANGE:

CONTACT SIZE	MIN. INSUL O.D.	MAX. INSUL O.D.	TYPICAL WIRE RANGE
16	2.24 mm (.088 in)	3.68 mm (.145 in)	14 - 20 AWG

SEE SHEET 2		REF: DT04-12PA-B016 . DT04-12PB-B016 . DT04-12PC-B016 . DT04-12PD-B016		ITEM
QUANTITY	PART NUMBER	DESCRIPTION		
<b>MATERIALS LIST</b>				
<b>UNLESS OTHERWISE SPECIFIED</b>		<b>SIGNATURES</b>	<b>DATE</b>	<p>Sine Systems - www.amphenol-sine.com 44724 Morley Drive Clinton Township, MI 48036</p>
1) All dimensions are in metric(mm).		DRAWN: LOUIE	18NOV21	
2) Tolerances are as follows: 1 PL DEC ±0.30 2 PL DEC ±0.15 3 PL DEC ±0.08		CHECKED: ORION	17NOV21	
3) Note reference =		ENGINEER:		
MATERIAL SPECIFICATIONS:		APPROVAL: TOMMY	18NOV21	<b>RECEPTACLE, 12 PIN, AT SERIES, KEYED</b>
WEIGHT: 27.1g		CUSTOMER:		
PROCESS SPECIFICATIONS:		THIS DRAWING IS SUPPLIED FOR INFORMATION ONLY. DESIGN FEATURES, SPECIFICATIONS AND PERFORMANCE DATA SHOWN HEREON ARE THE PROPERTY OF THE AMPHENOL CORPORATION. NO RIGHTS OF REPRODUCTION ARE IMPLIED. ALL DIMENSIONS ARE SUBJECT TO NORMAL MANUFACTURING VARIATIONS.		
NEXT ASSY:		SCALE: NONE		<b>SIZE</b> TYPE DWG NO: <b>AT04-12PX-XXX</b> <b>REVISION</b> <b>A4</b> SHEET 1 OF 2

TITLE: RECEPTACLE, 12 PIN, AT SERIES, KEYED  
DWG NO: AT04-12PX-XXX  
REV: A4  
SH: 1  
OF: 2

REVISIONS					
REV	ECO	DESCRIPTION	DATE	BY	APPR
A3	-	RELEASE NEW DRAWING FORMAT	02JAN14	JARRY	-
A4	C1403S	UPDATE THE APPEARANCE	16NOV21	LOUIE	TOMMY

P/N AT04-12PA  
KEY-A CONFIGURATION  
STANDARD COLOR: GREY

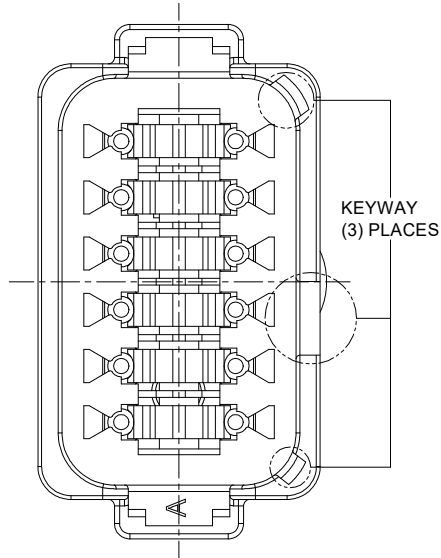

KEY-A CONFIGURATION	
COLOR	PART NUMBER
<b>* GREY</b>	<b>AT04-12PA</b>
BLACK	AT04-12PA-BLK
GREEN	AT04-12PA-GRN
BROWN	AT04-12PA-BRN

P/N AT04-12PB  
KEY-B CONFIGURATION  
STANDARD COLOR: BLACK

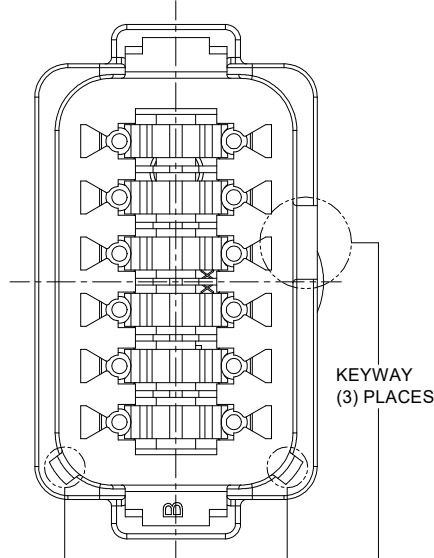

KEY-B CONFIGURATION	
COLOR	PART NUMBER
GREY	AT04-12PB-GRY
<b>* BLACK</b>	<b>AT04-12PB</b>
GREEN	AT04-12PB-GRN
BROWN	AT04-12PB-BRN

P/N AT04-12PC  
KEY-C CONFIGURATION  
STANDARD COLOR: GREEN

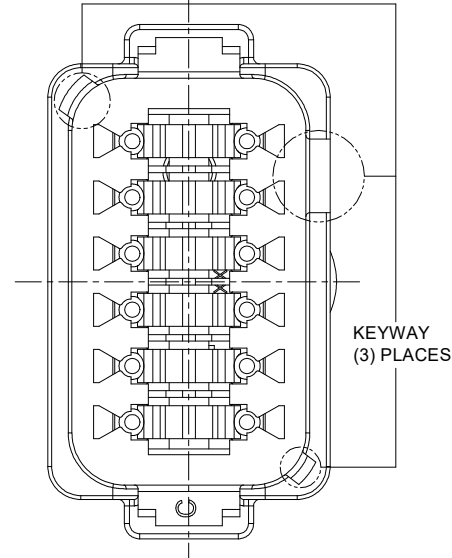

KEY-C CONFIGURATION	
COLOR	PART NUMBER
GREY	AT04-12PC-GRY
BLACK	AT04-12PC-BLK
<b>* GREEN</b>	<b>AT04-12PC</b>
BROWN	AT04-12PC-BRN

P/N AT04-12PD  
KEY-D CONFIGURATION  
STANDARD COLOR: BROWN

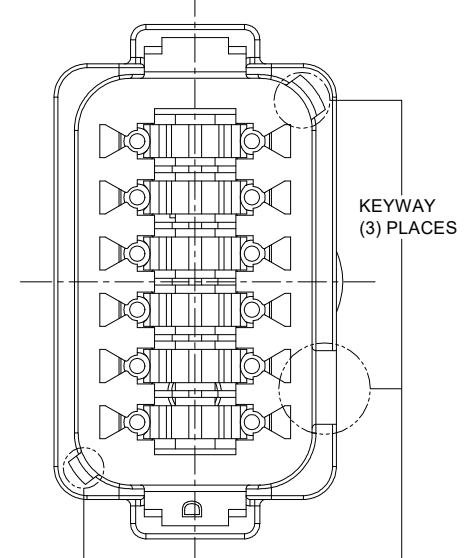

KEY-D CONFIGURATION	
COLOR	PART NUMBER
GREY	AT04-12PD-GRY
BLACK	AT04-12PD-BLK
GREEN	AT04-12PD-GRN
<b>* BROWN</b>	<b>AT04-12PD</b>

NOTE:

AN ASTERISKS ( \* ) PLACED BEFORE THE COLOR DENOTES THE STANDARD MOLDED COLOR OF THE CONNECTORS SHOWN ABOVE.

OTHER COLORS SHOWN ARE AVAILABLE VIA SPECIAL ORDER.

QUANTITY	PART NUMBER	DESCRIPTION	ITEM
<b>MATERIALS LIST</b>			
<b>UNLESS OTHERWISE SPECIFIED</b> 1) All dimensions are in metric(mm). 2) Tolerances are as follows: 1 PL DEC ±0.30 2 PL DEC ±0.15 3 PL DEC ±0.08 Fractions ±1/64 Angles ±1° 3) Note reference =		<b>SIGNATURES</b> <b>DATE</b> DRAWN: LOUIE    18NOV21 CHECKED: ORION    17NOV21 ENGINEER: APPROVAL: TOMMY    18NOV21 CUSTOMER:	
MATERIAL SPECIFICATIONS:		<div style="text-align: center;"> <h1>Amphenol</h1> <p>Sine Systems - www.amphenol-sine.com 44724 Morley Drive Clinton Township, MI 48036</p> </div>	
WEIGHT: 27.1g			
PROCESS SPECIFICATIONS:		RECEPTACLE, 12 PIN, AT SERIES, KEYED  SIZE    TYPE    DWG NO:    REVISION <b>B C-</b> AT04-12PX-XXX <b>A4</b>	
NEXT ASSY:			
THIS DRAWING IS SUPPLIED FOR INFORMATION ONLY. DESIGN FEATURES, SPECIFICATIONS AND PERFORMANCE DATA SHOWN HEREON ARE THE PROPERTY OF THE AMPHENOL CORPORATION. NO RIGHTS OF REPRODUCTION ARE IMPLIED. ALL DIMENSIONS ARE SUBJECT TO NORMAL MANUFACTURING VARIATIONS.		SCALE: NONE    SHEET 2 OF 2	

# A Series™ - Contact Size 16 Options (Works with: AT, ATV, AHD-9, ARC, DuraMate and PanelMate Series)

Machined Contacts, Sockets & Pins				
Part Number	Description	Size	AWG	Type
AT60-215-1631	Male Contact - Pin, Gold-plated	16	14	Machined
AT62-209-1631	Female Contact - Socket, Gold-plated	16	14	Machined
AT60-215-16141	Male Contact - Pin, Nickel-plated	16	14	Machined
AT62-209-16141	Female Contact - Socket, Nickel-plated	16	14	Machined
AT60-202-1631	Male Contact - Pin, Gold-plated	16	16-20	Machined
AT62-201-1631	Female Contact - Socket, Gold-plated	16	16-20	Machined
AT60-202-16141	Male Contact - Pin, Nickel-plated	16	16-20	Machined
AT62-201-16141	Female Contact - Socket, Nickel-plated	16	16-20	Machined
AT60-202-1631-22	Male Contact - Pin, Gold-plated	16	22-24	Machined
AT62-201-1631-22	Female Contact - Socket, Gold-plated	16	22-24	Machined
AT60-202-16141-22	Male Contact - Pin, Nickel-plated	16	22-24	Machined
AT62-201-16141-22	Female Contact - Socket, Nickel-plated	16	22-24	Machined

Tooling - Machined Contacts	
Part Number	Description
AUTK-16	Hand Crimp Tool, Size 16
AUTK-100	Universal Heavy Duty Contact Crimping Tool Kit, Size 12/16/20
CA-5D12	Universal Hand Crimp Tool, Size 12/16/20
CA-5E12	Pneumatic Crimp Tool, Size 12/16/20

Contact Removal Tools (For both Machined or Stamped & Formed Contacts)	
Part Number	Description
ATRT-100	Contact and Wedgelock Extraction Tool
AT11-310-1605	Contact Removal Tool, Plastic, Size 16

Sealing Plugs (For both Machined or Stamped & Formed Contacts)	
Part Number	Description
A114017	Sealing Plug, Size 16, White
A114017-SR	Sealing Plug, Size 16, SR01 Series, Black
AT13-217-1605	Locking Sealing Plug, Size 16, Grey
AT13-217-1605-SR	Locking Sealing Plug, Size 16, SR01 Series, Red

Stamped & Formed Contacts, Sockets & Pins				
Part Number	Description	Size	AWG	Type
AT60-14-0122	Male Contact - Pin, Nickel-plated	16	14-18	Stamped & Formed
AT62-14-0122	Female Contact - Socket, Nickel-plated	16	14-18	Stamped & Formed
AT60-14-0144	Male Contact - Pin, Gold-plated	16	14-18	Stamped & Formed
AT62-14-0144	Female Contact - Socket, Gold-plated	16	14-18	Stamped & Formed
AT60-16-0122	Male Contact - Pin, Nickel-plated	16	16-18	Stamped & Formed
AT62-16-0122	Female Contact - Socket, Nickel-plated	16	16-18	Stamped & Formed
AT60-16-0144	Male Contact - Pin, Gold-plated	16	16-18	Stamped & Formed
AT62-16-0144	Female Contact - Socket, Gold-plated	16	16-18	Stamped & Formed
AT60-16-0622	Male Contact - Pin, Nickel-plated	16	16-20	Stamped & Formed
AT62-16-0622	Female Contact - Socket, Nickel-plated	16	16-20	Stamped & Formed
AT60-16-0644	Male Contact - Pin, Gold-plated	16	16-20	Stamped & Formed
AT62-16-0644	Female Contact - Socket, Gold-plated	16	16-20	Stamped & Formed
AT60-16-0677	Male Contact - Pin, Tin-plated	16	16-20	Stamped & Formed
AT62-16-0677	Female Contact - Socket, Tin-plated	16	16-20	Stamped & Formed
AT60-16-0822	Male Contact - Pin, Nickel-plated	16	20-22	Stamped & Formed
AT62-16-0822	Female Contact - Socket, Nickel-plated	16	20-22	Stamped & Formed
AT60-16-0844	Male Contact - Pin, Gold-plated	16	20-22	Stamped & Formed
AT62-16-0844	Female Contact - Socket, Gold-plated	16	20-22	Stamped & Formed

Tooling - Stamped & Formed Contacts	
MFX-3950	Crimp Die - Size 16, 18-20AWG
MFX-3953	Crimp Die - Size 16, 16-18AWG
MFX-3975	Crimp Die - Size 16, 14-16AWG
MFX-3990	Crimp Die - Size 16, 20-22AWG
ATT-16-00	Hand Crimp Tool - Size 16, 14-16AWG
ATT-16-01	Hand Crimp Tool - Size 16, 18-20AWG
ATT-1612-03	Hand Crimp Tool - Size 16, 20-22AWG

勝特力電材超市-龍山店 886-3-5773766  
 勝特力電材超市-光復店 886-3-5729570  
 勝特力電子(上海) 86-21-34970699  
 勝特力電子(深圳) 86-755-83298787  
<http://www.100y.com.tw>