



圓形工業連接器 Circular Connectors

Industrial High Reliability
Interconnect Solutions

勝特力電材超市-龍山店 886-3-5773766
勝特力電材超市-光復店 886-3-5729570
勝特力电子(上海) 86-21-34970699
勝特力电子(深圳) 86-755-83298787
<http://www.100y.com.tw>

Invax 

CR Series CR系列



- Solid metal shell construction
- Threaded coupling & color coded ring option
- Cost effective for industrial grade application

- Key polarization and alternate position
- Gold plated & solder contact terminals

No. of contacts 接點數及電氣規格：

CR2:	2, 3, 4	15A/250V	CR4:	4, 7, 8, 10	15A/250V
	4, 7	10A/250V		12, 16	8A/250V
	8	9A/250V		17	9A/150V
	12	4A/250V		20, 26	4A/250V
CR3:	4, 5	15A/250V	CR5:	24	8A/250V
	10	10A/250V			
	16	6A/250V			
	16	4A/250V			



*Black Color Available

Series 規格系列	CRxR Box Mounting (Square Flange) 方形面板座						CRxA Box Mounting (Round Flange w/Hex Lock Nut) 圓形面板座					CRxD Wall Mounting w/backshell (Square Flange) 方形面板座 (束線式)								
	Male (公)			Female (母)			Male (公)		Female (母)			Male (公)		Female (母)						
Connector Style 外型式樣																				
Outer Dimension of Connector 外型尺寸	A		B	C		D	E	F	A		B	C	D	E	A		B	C	D	E
	CR2	21.8	26.4	SQ 23.0	SQ 29.0	3.2	19.8	21.8	26.4	9.9	28.5	19.8	21.8	47.8	SQ 23.0	SQ 29.0	3.2			
CR3	25.8	26.8	SQ 26.0	SQ 32.0	3.2	24.0	25.8	26.8	10.3	31.5	24.0	25.8	53.4	SQ 26.0	SQ 32.0	3.2				
CR4	29.8	26.8	SQ 29.0	SQ 35.0	3.2	27.6	29.8	26.8	10.5	34.5	27.6	29.8	55.0	SQ 29.0	SQ 35.0	3.2				
CR5	37.8	40.0	SQ 35.0	SQ 44.8	3.2	34.9	—	—	—	—	—	—	—	—	—	—	—	—	—	

Series 規格系列	CRxK-10 Extender Straight Plug w/bushing 延長套環型接線接頭 (束線式)				CRxP-10 Straight Plug w/bushing 延長套環型接線接頭 (束線式)				CRxE-10 Cable Extender w/bushing 延長型接線接頭 (束線式)						
	Male (公)		Female (母)		Male (公)		Female (母)		Male (公)		Female (母)				
Connector Style 外型式樣															
Outer Dimension of Connector 外型尺寸	A		B	C	D	A		B	C	D	A		B	C	D
	CR2	21.8	48.7	8.5	25.5	16.0	50.0	8.5	25.5	21.8	48.7	8.5	23.5		
CR3	25.8	53.4	9.8	30.0	20.5	53.0	9.8	30.0	25.8	53.4	9.8	27.0			
CR4	29.8	55.0	12.5	33.8	24.5	56.0	12.5	33.8	29.8	55.0	12.5	31.5			
CR5	—	—	—	—	32.7	70.0	16.5	43.0	—	—	—	—			

圓形工業連接器



Series 規格系列	CRxP-20 Straight Plug (For flexible conduit) 套環型接線接頭 (浪管式)				CRxE-20 Cable Extender (For flexible conduit) 延長型接線接頭 (浪管式)				CRxP-Bxx Straight Plug (w/plastic cable gland clamp) 套環型接線接頭 (迫緊束線式)			
	Contact Male (公)		Female (母)		Male (公)		Female (母)		Male (公)		Female (母)	
Connector Style 外型式樣												
Outer Dimension of Connector 外型尺寸												
	A	B	C	D	A	B	C	D	A	B	C	D
CR2	16.0	57.5	11.3	25.5	21.8	56.5	11.3	23.5	16.0	78.4	12.0	27.0
CR3	20.5	62.5	11.3	30.0	25.8	62.8	11.3	27.0	20.5	84.5	12.0	27.0
CR4	24.5	62.5	14.7	33.8	29.8	62.8	14.7	31.5	24.5	88.3	16.0	33.0
CR5	—	—	—	—	—	—	—	—	—	—	—	—

Series 規格系列	CRxE-Bxx Cable Extender (w/plastic cable gland clamp) 延長型接線接頭 (迫緊束線式)			
	Contact Male (公)		Female (母)	
Connector Style 外型式樣				
Outer Dimension of Connector 外型尺寸				
	A	B	C	D
CR2	21.8	77.8	12.0	27.0
CR3	25.8	85.0	12.0	27.0
CR4	29.8	89.6	16.0	33.0
CR5	—	—	—	—

CS Series CS系列

- Solid metal shell construction
- Threaded coupling hard dielectric inserts
- Cost effective for industrial grade application

- Front Key polarization
- Solder contact terminals

No. of contacts 接點數及電氣規格：

CS1-H :	2, 3, 4, 5, 6, 7	5A / 125V
CS1 :	2, 3, 4, 5, 6, 7, 8, 9, 10	5A / 125V
CS2 :	2, 3, 4, 5, 6, 7, 8, 9, 10, 12, 14	7A / 250V
CS3 :	2, 3, 4, 5, 6, 7	10A / 250V
CS4 :	2, 3, 4, 5, 7	15A / 250V
	8	5A / 250V

CS5 :	1	250A / 250V
	2, 3	30A / 250V
CS6 :	4	30A / 250V



*Black Color Available

Series 規格系列	CSxA Box Mounting Round Flange w/Hex Lock Nut 圓形面板座						CSxR Box Mounting (Screw Flange) 圓形面板座						CSxP-00 Straight Plug 套環型接線接頭 (束線式)			
	Male (公)			Female (母)			Male (公)			Female (母)			Male (公)		Female (母)	
Connector Style 外型式樣																
Outer Dimension of Connector 外型尺寸																
	A	B	C	D	E	F	A	B	C	D	E	F	A	B	C	D
CS1-H	12.6	5.1	20.4	14.6	10.9	11.6	—	—	—	—	—	—	9.0	15.3	5.0	35.0
CS1	15.7	5.1	20.4	19.0	14.7	15.7	—	—	—	—	—	—	12.7	18.0	6.5	35.8
CS2	—	—	—	—	—	—	33.0	25.0	120	25.5	3.3	18.9	15.5	22.0	9.0	43.0
CS3	—	—	—	—	—	—	42.2	27.5	120	33.5	3.3	24.9	21.1	27.7	10.8	50.3
CS4	—	—	—	—	—	—	46.0	29.3	120	38.0	3.3	30.0	25.6	33.0	12.0	54.8
CS5	—	—	—	—	—	—	51.0	35.5	120	42.0	3.3	32.0	27.7	38.0	15.5	64.5
CS6	—	—	—	—	—	—	58.0	36.6	120	50.0	3.3	40.0	35.0	46.0	16.4	69.0

Series 規格系列	CSxE-00 Cable Extender 延長型接線接頭 (束線式)				CSxP-20 Straight Plug (For flexible conduit) 套環型接線接頭 (浪管式)				CSxE-20 Cable Extender 延長型接線接頭 (浪管式)			
	Male (公)		Female (母)		Male (公)		Female (母)		Male (公)		Female (母)	
Connector Style 外型式樣												
Outer Dimension of Connector 外型尺寸												
	A	B	C	D	A	B	C	D	A	B	C	D
CS1-H	—	—	—	—	—	—	—	—	—	—	—	—
CS1	15.7	17.8	6.6	43.8	—	—	—	—	—	—	—	—
CS2	—	—	—	—	—	—	—	—	—	—	—	—
CS3	24.8	28.7	10.8	57.4	21.1	27.7	11.3	60.0	24.8	28.7	11.3	60.2
CS4	29.0	34.0	12.0	63.5	25.6	33.0	11.3	60.0	29.0	34.0	11.3	65.3
CS5	—	—	—	—	—	—	—	—	—	—	—	—
CS6	—	—	—	—	—	—	—	—	—	—	—	—

圓形工業連接器



Series 規格系列	CSxP-Bxx Straight Plug (w/plastic cable gland clamp) 套環型接線接頭 (迫緊束線式)				CSxE-Bxx Cable Extender 延長型接線接頭 (迫緊束線式)			
	Male (公)		Female (母)		Male (公)		Female (母)	
Connector Style 外型式樣								
Outer Dimension of Connector 外型尺寸								
	A	B	C	D	A	B	C	D
CS1-H	—	—	—	—	—	—	—	—
CS1	—	—	—	—	—	—	—	—
CS2	—	—	—	—	—	—	—	—
CS3	21.1	27.7	12.0	84.1	24.8	28.7	12.0	86.0
CS4	25.6	33.0	12.0	90.2	29.0	34.0	12.0	92.0
CS5	—	—	—	—	—	—	—	—
CS6	—	—	—	—	—	—	—	—

Series 規格系列	CR / CS Dust Cap 防塵蓋												
	Metal Cap 金屬蓋				Plastic Cap 塑膠蓋				Rubber Dust Cap 墊圈防塵蓋				
Cap Style 外型式樣													
Outer Dimension 外型尺寸													
	A	B	C	D	A	B	C	D	A	B	C	D	
CR	CR2	25.5	M22*1.0	7.2	5.3	28.0	M22*1.0	9.0	5.3	20.8	19.6	—	sq 23
	CR3	28.5	M26*1.0	8.2	5.3	32.0	M26*1.0	9.0	5.3	24.8	23.8	—	sq 26
	CR4	34.0	M30*1.0	8.2	5.3	36.0	M30*1.0	9.0	5.3	28.8	27.3	—	sq 29
	CR5	—	—	—	—	—	—	—	—	36.8	34.6	—	sq 35
CS	CS1	—	—	—	—	—	—	—	—	15.3	15.8	120	20.0
	CS2	—	—	—	—	—	—	—	—	17.8	18.6	120	25.5
	CS3	28.5	M25*1.25	8.2	5.3	32.0	M25*1.25	9.0	5.3	23.8	25.0	120	33.8
	CS4	34.0	M29.2*1.0	8.2	5.3	36.0	M29.2*1.0	9.0	5.3	28.0	30.0	120	38.0
	CS5	—	—	—	—	—	—	—	—	32.8	31.6	120	42.0
	CS6	—	—	—	—	—	—	—	—	40.2	39.5	120	50.0

CM Series CM系列

- Subminiature size metal shell construction
- Threaded coupling and gold plated contacts
- Cost effective for instrument application
- Solder contacts and molded on wire options

No. of contacts 接點數及電氣規格：

CM1 : 3, 4, 5 2A / 125V

CM2 : 7 1A / 125V

* Dimensions subject to change without notice.



*Cable Clamp

Series 規格系列	CMxR Box Mounting w/Hex Nut 面板座				CMxP-10 Straight Plug 套管型接線接頭 (配管不含線)				CMxE-10 Cable Extender 延長型接線接頭 (配管不含線)			
	Male (公)		Female (母)		Male (公)		Female (母)		Male (公)		Female (母)	
Connector Style 外型式樣												
Outer Dimension of Connector 外型尺寸												
	A	B	C	D	A	B	C	D	A	B	C	D
CM1	9.5	6.6	17.8	10.0	7.5	46.5	4.0	11.4	9.5	44.5	4.0	6.6
CM2	10.0	6.2	16.0	11.2	7.1	41.0	4.0	11.5	10.0	42.0	4.0	6.0

Series 規格系列	CMxP-MD Straight Plug (w/Molding Cable) 套環型接線接頭 (含線成型)				CMxE-MD Cable Extender (w/molding cable) 套環型接線接頭 (迫緊束線式)			
	Male (公)		Female (母)		Male (公)		Female (母)	
Connector Style 外型式樣								
Outer Dimension of Connector 外型尺寸								
	A	B	C	D	A	B	C	D
CM1	7.5	16.0	4.0	11.4	9.5	16.0	4.0	6.6
CM2	7.1	14.0	4.0	11.5	10.0	17.5	4.0	6.0

CT Series CT系列

- Robust Aluminum alloy shell construction
- Threaded coupling conform IP-67
- Heavy duty for industrial grade application
- Front Key polarization and alternate positions
- Hard gold plated Solder contact terminals

No. of contacts 接點數及電氣規格：

CT4 : 4,5,6+1 50A / 250V
19 25A / 250V



Series 規格系列	CT4R				CT4C				CT4E-S0				CT4P-S0				CT4E-L0				CT4P-L0						
	Box / Wall Mounting (Screw Flange) 面板座								Short Backshell (w/plastic cable gland clamp) 接線短柄接頭								Long Backshell (w/plastic cable gland clamp) 接線長柄接頭										
Contact	Female Receptacle (母)				Male Plug (公)				Female Cable Extender (母)				Male Straight Plug (公)				Female Cable Extender (母)				Male Straight Plug (公)						
Connector Style 外型式樣																											
Outer Dimension of Connector 外型尺寸																											
	A	B	C	D	A	B	C	D	A	B	C	D	A	B	C	D	A	B	C	D	A	B	C	D	A	B	C
CT4	45.8	25.7	sq41	sq56	50.0	35.8	sq41	sq56	45.8	87.5	26.5	56.6	50.0	93.0	26.5	64.0	45.8	127	26.5	56.6	50.0	135	26.5	64.3			

CA Series CA系列

CA IP67防水連接器

- IP67 rating Protection when mated
- 4 and 7 pole versions with leading earth contact
- Plug or socket connection in each body style
- Cable acceptance 4-9mm
- Straight and Right angle cable entry
- For power and control signal connecting applications
- Screw 4P and solder 7P type terminations
- Polarizing key design - cannot be mis-connected
- Sealing caps available for unmated protection
- Compact and black/blue color shell options
- Easy assembly - no special tools required



No. of contacts 接點數及電氣規格：

CA3 :	4	16A / 400V
	7	10A / 250V

Series 規格系列	CA3E Cable Extender (w/plastic cable gland clamp) 延長型接線公頭 (迫緊束線式)				CA3P Straight Plug (w/plastic cable gland clamp) 套環型接線母頭 (迫緊束線式)				CA3E-R (90°) Cable Extender 90° (w/plastic cable gland clamp) 延長型接線公頭 (迫緊束線式)				CA3P-R (90°) Straight Plug 90° (w/plastic cable gland clamp) 套環型接線母頭 (迫緊束線式)			
	Connector Style 外型式樣															
Outer Dimension of Connector 外型尺寸																
	A	B	C	D	A	B	C	D	A	B	C	D	A	B	C	D
CA	14.0	76.0	9.0/13.0	30.7	13.5	75.0	9.0/13.0	30.2	62.0	53.0	9.0/13.0	30.7	62.0	53.0	9.0/13.0	30.2

Series 規格系列	CA3R Box Mounting (Screw Flange) 圓形面板公座							CA3C Box Mounting (Screw Flange) 圓形面板母座							CA3-A32 Plastic Cap 塑膠蓋				CA3-A31 Plastic Cap 塑膠蓋			
	Connector Style 外型式樣																					
Outer Dimension of Connector 外型尺寸																						
	A	B	C	D	E	F	G	A	B	C	D	E	F	G	A	B	C	D	A	B	C	D
CA	18.5	8.4	21.5	3.6	31.0	38.0	28.2	18.7	8.6	21.5	3.6	31.0	38.0	28.5	28.8	23.0	25.8	3.0	28.4	23.8	30.8	3.0

Part No. Code : 型號編碼表

CR Series

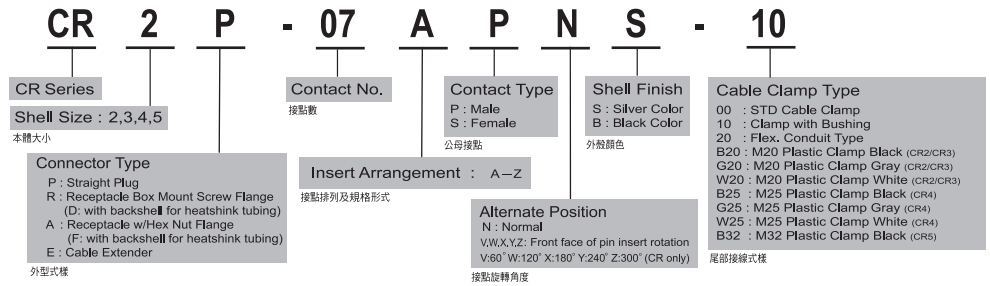

CRB Series

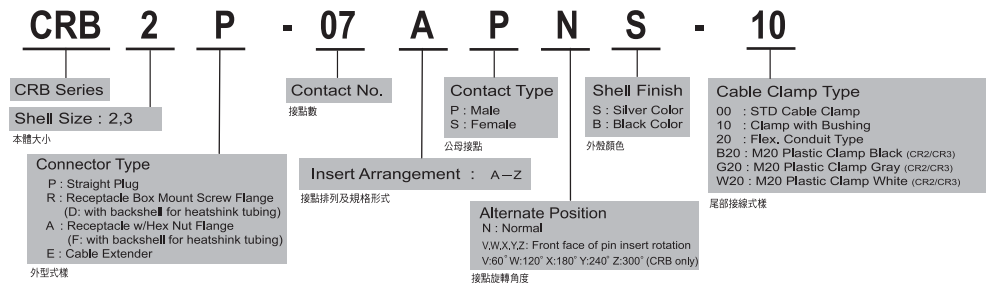

CS Series

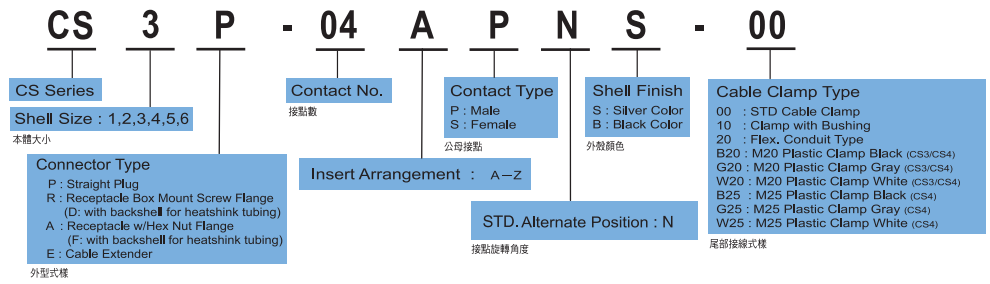

CT Series

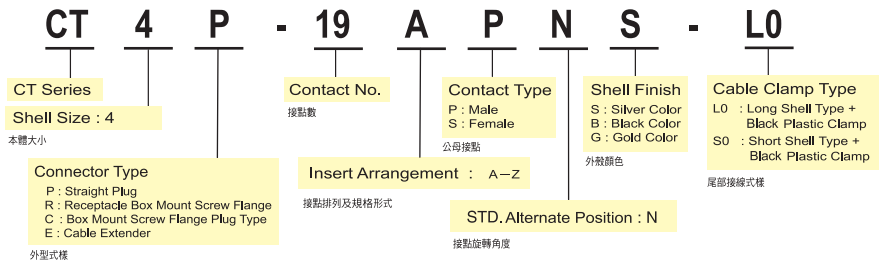

CM Series

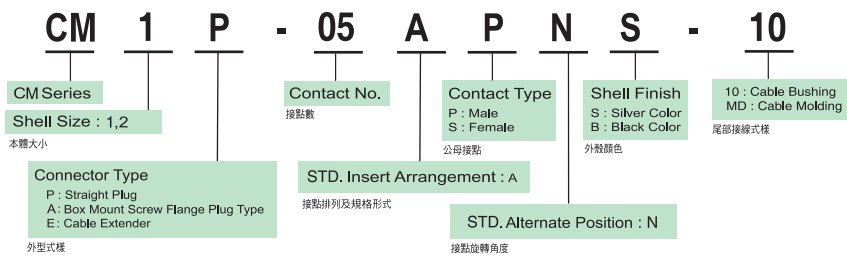

CA3 Series

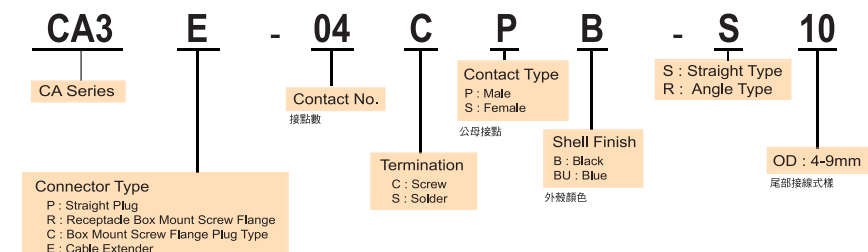

CRB Series

CRB 系列 旋扣式防震快速連接器



- Solid metal shell construction
- Quick bayonet coupling for rapid mating and unmating
- Notable resistance to shocks and Vibrations
- Use the same pin arrangement as CR2/CR3 series
- Gold /Tin plated & Solder contact terminals
- UL certified

No. of contacts 接點數及電氣規格：

CRB2 : 2, 3, 4	15A/250V
4, 7	10A/250V
8	9A/250V
12	4A/250V

CRB3 : 4, 5	15A/250V
10	10A/250V
16	6A/250V
16	4A/250V



CX / CXD Series

CX 螺牙式 / CXD 快扣式連接器

- Solid metal shell construction
- Thread coupling CX and ball locking CXD push-pull rapid mating and unmating
- Gold /Tin plated & Solder contact terminals
- Dimension: OD 16mm, Flange size 18x18mm

No. of contacts 接點數及電氣規格：

CX1 : 2, 3	5A / 250V
4, 5, 6, 7	5A / 125V

CXD1: 2, 3	5A / 250V
4, 5, 6, 7	5A / 125V



MIL-STD Connectors

軍規圓型連接器

MIL-DTL-5015 Series



Threaded Coupling 螺牙式

MS3100	Wall mounting receptacle
MS3101	Inline cable connecting plug
MS3102	Box mounting receptacle
MS3106	Straight plug
MS3108	90 degree plug

MIL-DTL-26482 Series



Bayonet Coupling 旋扣式

MS3110	Wall mounting receptacle
MS3111	Inline cable connecting plug
MS3112	Box mounting receptacle
MS3114	Jam nut mounting receptacle
MS3116	Straight plug

VG 95234 Series



Bayonet Coupling 旋扣式

MIL-DTL-5015 STD

Power Safe Connector

大容量 IP67 單極纜線電力接頭

PS Series 800A 2kV AC / 3kV DC

- 防呆及防鬆脫插接
- 自動接點防護設計
- 穩定簧片鍍銀接點
- 強固耐高低溫衝擊
- 可靠穩定彈性防震
- 多色及KEY位選用



CR Series --Mating Styles Configuration

對接式樣圖

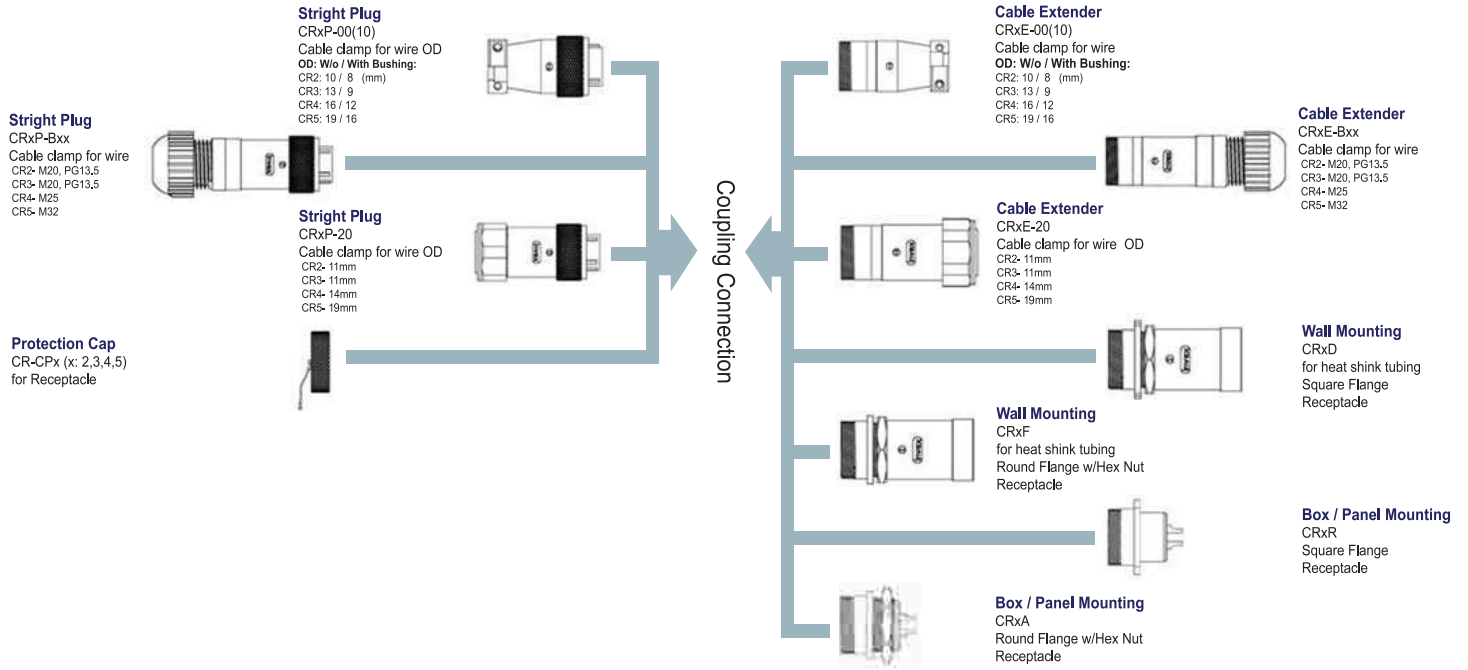

線規對照表

Conversion Chart of American Wire Gauge

美規線號	耐電流 (A)		平方值			導體直徑
Size AWG or MCM	Amperes Single Cond. 75°C Copper (NFPA)	Circular Mils	Area Square Inches	Square mm	Inches ClassM (NEMA)	Approx Diameter (mm)
20	7	1020	0.0008	0.52	0.038	0.97
18	10	1620	0.0013	0.82	0.048	1.22
16	15	2580	0.0020	1.31	0.060	1.52
14	20	4110	0.0032	2.08	0.078	1.98
12	25	6530	0.0051	3.31	0.101	2.57
10	40	10380	0.0082	5.26	0.126	3.20
8	65	16510	0.0130	8.37	0.162	4.11
6	95	26240	0.0206	13.30	0.215	5.46
4	125	41740	0.0328	21.15	0.269	6.83
2	170	66360	0.0521	33.62	0.337	8.56
1	195	83690	0.0657	42.41	0.376	9.55
1/0	230	105600	0.0829	53.50	0.423	10.74
2/0	265	133100	0.1045	67.43	0.508	12.90
3/0	310	167800	0.1318	85.01	0.576	14.63
4/0	360	211600	0.1662	107.20	0.645	16.38
250 MCM	405	250000	0.1964	126.70	0.713	18.11
300 MCM	445	300000	0.2356	152.00	0.768	19.51
500 MCM	620	500000	0.3927	253.40	0.997	25.32
750 MCM	785	750000	0.5891	380.00	1.207	30.66
1000 MCM	935	1000000	0.7854	506.70	1.404	35.66

勝特力電材超市-龍山店 886-3-5773766
 勝特力電材超市-光復店 886-3-5729570
 勝特力电子(上海) 86-21-34970699
 勝特力电子(深圳) 86-755-83298787
<http://www.100y.com.tw>