

## EMI Quiet Modular Jacks with LED's



is a family of EMI Quiet Modular Jack Connectors with built-in LEDs, meets Ethernet CAT 5 performance. This product is ideal for LAN applications such as adapter cards and routers. Shielded and non-shielded versions are available, with a variety of LED colors, and ports.



## Specifications

### MATERIAL

**Shield:** Copper Alloy; Tin/Lead Plated  
**Contacts:** Phosphor Bronze; Gold over Nickel  
**Insert:** Solder reflow process compatible (Complies with UL 94V-0)

### ELECTRICAL

**Contact Resistance:** 20 milliohms maximum  
**Insulation Resistance:** 500 megohms minimum  
**Current Rating:** 1.5 Amps  
**Voltage Rating:** 125 Volts AC  
**Dielectric Withstanding Voltage:** 1000 VAC, RMS. 60 Hz. 1 min.

### Standard LEDs: For 5.0 V Systems

**Forward Voltage:** 2.1 Volts Typical  
**Reverse Voltage:** 6.0 Volts minimum  
**Luminous Intensity:** 0.5 mCd minimum (at If=2mA)

### Low Current LEDs: For 3.3 V Systems

**Forward Voltage:** 2.0 Volts Typical  
**Reverse Voltage:** 6.0 Volts minimum  
**Luminous Intensity:** 1.0 mCd minimum (at If=2mA)

### Other Parameters:

**Storage Temperature:** -20° C to 85° C  
**Lead Soldering Temperature:** 260° C (5 sec)  
**Plating on Tails:** Tin-Lead (90-10) alloy  
**UL File # :** E135615  
**CSA File # :** LR68598

## Ordering Information

RJHS - X X X X - XX

**X VERSION**  
 3 - vertical mount, RJ45, 8 contacts  
 5 - 8 position, RJ45, flat contact  
 7 - 6 position, RJ11, flat contact  
 L - low profile, 8 position

**X SHIELDING OPTION**  
 0 - no shield  
 3 - shielded  
 4 - one port shield similar to code 3 but with side ground tabs  
 7 - shield with ground lug (single port)

**X NUMBER OF CONTACTS**  
 4 - 4 contacts (6 position)  
 6 - 6 contacts (6 position)  
 8 - 8 contacts (8 position)

### NUMBER OF PORTS

Blank - Single port  
 02 - 2 ports  
 03 - 3 ports  
 04 - 4 ports  
 05 - 5 ports  
 06 - 6 ports  
 07 - 7 ports  
 08 - 8 ports

### LED DESIGNATION

0 - blocked  
 1 - led 1 green, led 2 yellow  
 2 - led 1 green  
 3 - led 2 yellow  
 4 - led 1 yellow, led 2 green  
 5 - led 1 green, led 2 green  
 6 - led 1 yellow, led 2 yellow  
 A - led 1+2 - bi-colour yellow/green  
 B - led 1+2 - bi-colour red/green

Options for style, shield & contacts available.  
 Contact Amphenol Canada for more information

For additional colour combinations  
 refer to Chart RJHS Page 2

# RJHS Series

RJ vista

EMI QUIET - WITH LEDS

## LED Designation

RJHS - 538 1\* - 08

### \* LED DESIGNATION CODE

LED CODE	LED 2 Left	LED 1 Right
0	Blocked	Blocked
1	Yellow	Green
2	Blocked	Green
3	Yellow	Blocked
4	Green	Yellow
5	Green	Green
6	Yellow	Yellow
7	Red	Green
8	Green	Red
9	Green	Blocked
A	BiC Gr/YI	BiC Gr/YI
B	BiC Rd/Gr	BiC Rd/Gr
C	BiC Rd/Gr	BiC Gr/YI
D	Green	BiC Gr/YI
E	Yellow	BiC Gr/YI
F	BiC Gr/YI	Yellow
G	BiC Gr/Or	BiC Gr/Or
H	BiC Gr/YI	Green
J	BiC Rd/Gr	Yellow
K	Yellow	BiC Gr/Or
L	BiC Rd/Gr	Red
M	Red	Yellow
N	BiC Gr/Rd	BiC Gr/YI
P	Green	BiC Rd/Gr
R	BiC Gr/Or	Green
T	Red	Red
V	BiC Rd/Gr	Green
W	Special Designation (add digit to part number)	
Z		

RJHS - 538 W - 08 2\*

### \* SPECIAL LED DESIGNATION

SPECIAL DESIGNATION	LED 2 Left	LED 1 Right
0	See standard Design	
1	Red	Blocked
2	BiC Gr/YI	Yellow
3	Yellow	Red
4	Blocked	Red
5	Blocked	Yellow
6	Red	BiC Gr/YI
7		
8		
9		

### LOW CURRENT LED OPTIONS

A	Yellow	Yellow
B	Yellow	Green
C	Green	Yellow
D	Green	Green

LED 2

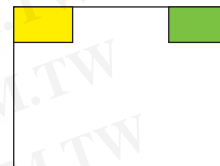

LED 1

勝特力材料 886-3-5753170  
 勝特力电子(上海) 86-21-34970699  
 勝特力电子(深圳) 86-755-83298787

[Http://www.100y.com.tw](http://www.100y.com.tw)

\* Contact Amphenol Canada for more information

# RJHS Series



EMI QUIET - WITH LEDS

## Single Port

### NON-SHIELDED

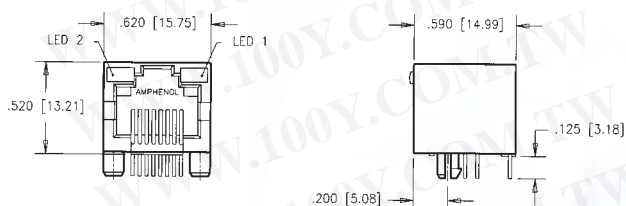

### PCB LAYOUT

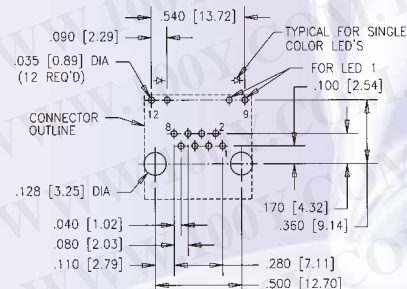

勝特力材料 886-3-5753170  
 勝特力电子(上海) 86-21-34970699  
 勝特力电子(深圳) 86-755-83298787  
[Http://www.100y.com.tw](http://www.100y.com.tw)

### BI-COLOUR LEDS



### SHIELDED WITH TOP & SIDE GROUND TABS

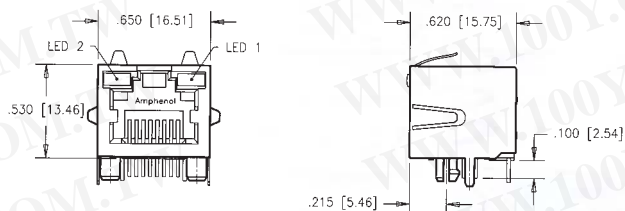

### PCB LAYOUT

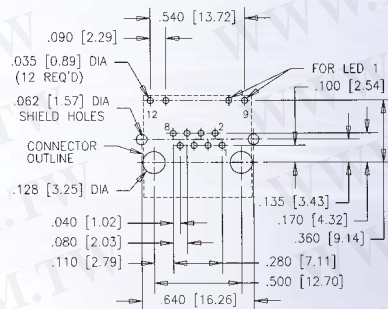

### SHIELDED WITH GROUND LUG

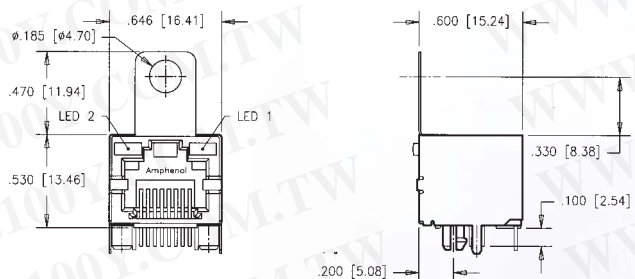

### PCB LAYOUT

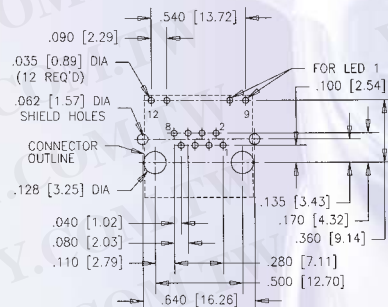



# RJHS Series



EMI QUIET - WITH LEDS

## VERTICAL MOUNT SINGLE PORT ONLY

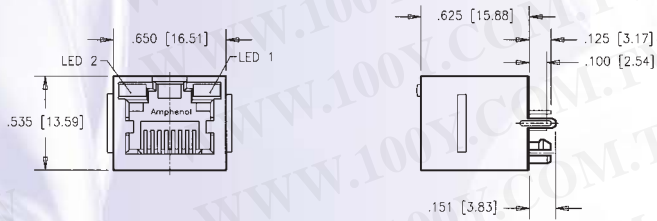

## PCB LAYOUT

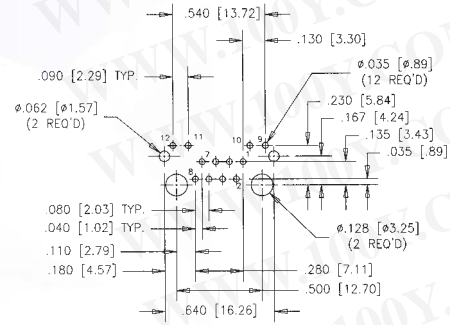

## LOW PROFILE SINGLE & 2 PORT

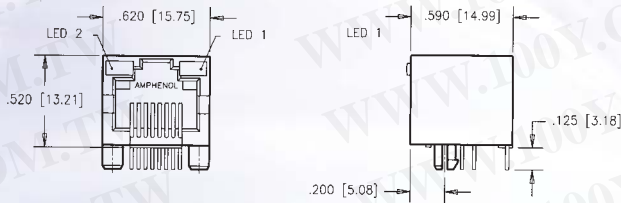

## PCB LAYOUT

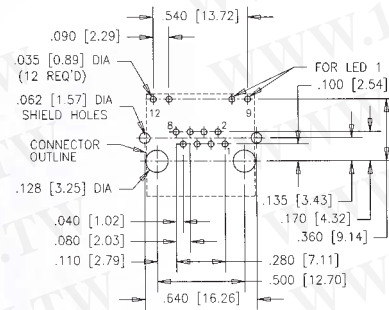

## SHORTING BARS SINGLE & 2 PORT

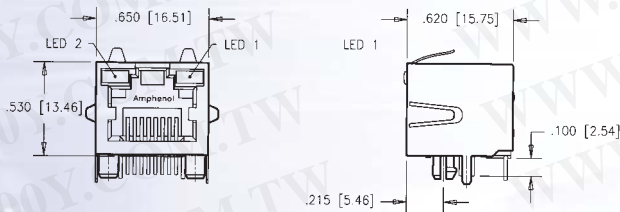

## PCB LAYOUT

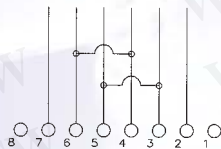
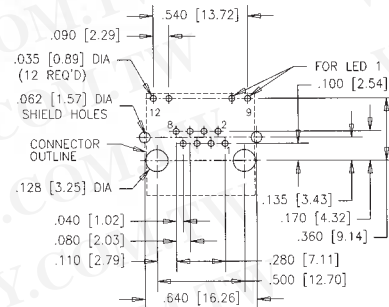

SHORTING BARS (CIRCUIT)

勝特力材料 886-3-5753170  
 勝特力电子(上海) 86-21-34970699  
 勝特力电子(深圳) 86-755-83298787  
[Http://www.100y.com.tw](http://www.100y.com.tw)

# RJHS Series

RJ vista™

EMI QUIET - WITH LEDS

## EMI Quiet Modular Jacks with LED's Multiport

RJ vista™ is a family of EMI Quiet Modular Jack Connectors with built-in LEDs, designed for Category 5 ethernet performance. This product is ideal for LAN applications such as adapter cards and routers. Shielded and non-shielded versions are available, with a variety of LED colors, and ports.



### SHIELDED 2 PORT

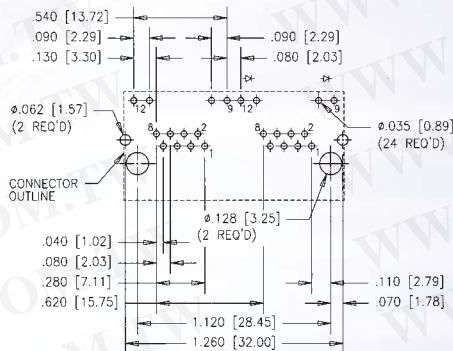
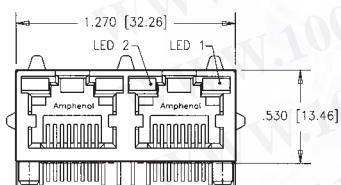

### SHIELDED 3 PORT

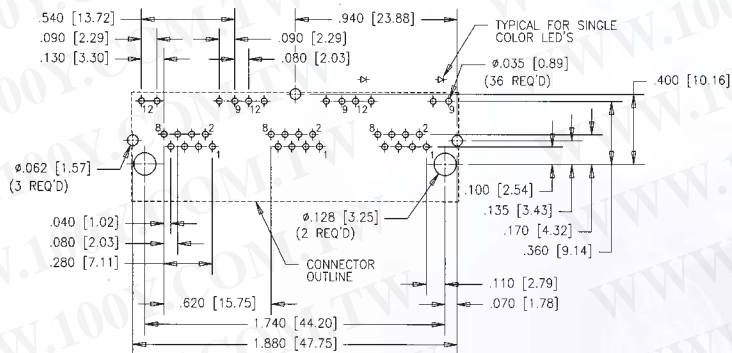
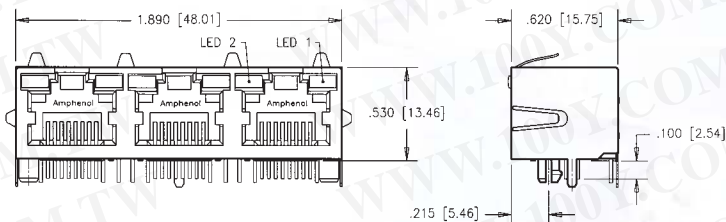

勝特力材料 886-3-5753170  
 勝特力电子(上海) 86-21-34970699  
 勝特力电子(深圳) 86-755-83298787  
[Http://www.100y.com.tw](http://www.100y.com.tw)

# RJHS Series



EMI QUIET - WITH LEDS

SHIELDED WITH TOP AND SIDE GROUND TABS (AVAILABLE IN MULTI-PORT)

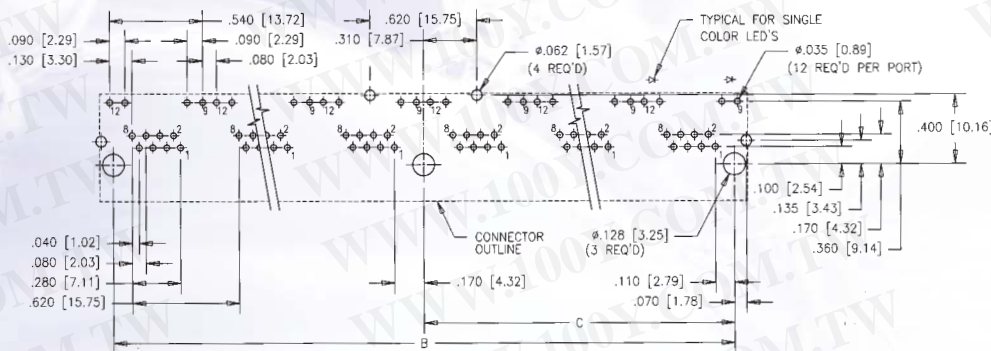
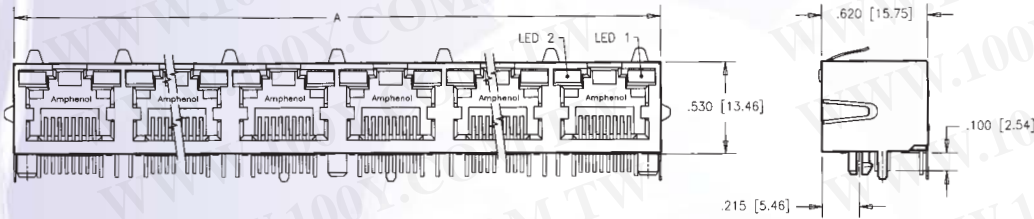

Number of ports	A	B	C
2	see page 5	see page 5	see page 5
3	see page 5	see page 5	see page 5
4	2.510[63.75]	2.360[59.94]	1.180[29.97]
6	3.750[95.25]	3.600[91.44]	1.800[45.72]
8	4.990[126.75]	4.840[122.94]	2.420[61.47]

勝特力材料 886-3-5753170  
 勝特力电子(上海) 86-21-34970699  
 勝特力电子(深圳) 86-755-83298787  
[Http://www.100y.com.tw](http://www.100y.com.tw)