

HFBR-0400Z, HFBR-14xxZ and HFBR-24xxZ Series

Low Cost, Miniature Fiber Optic Components
with ST®, SMA, SC and FC Ports



Data Sheet

勝特力材料 886-3-5753170
勝特力电子(上海) 86-21-34970699
勝特力电子(深圳) 86-755-83298787
[Http://www.100y.com.tw](http://www.100y.com.tw)



Description

The HFBR-0400Z Series of components is designed to provide cost effective, high performance fiber optic communication links for information systems and industrial applications with link distances of up to 2.7 kilometers. With the HFBR-24x6Z, the 125 MHz analog receiver, data rates of up to 160 megabaud are attainable.

Transmitters and receivers are directly compatible with popular "industry-standard" connectors: ST®, SMA, SC and FC. They are completely specified with multiple fiber sizes; including 50/125 μm , 62.5/125 μm , 100/140 μm , and 200 μm .

The HFBR-14x4Z high power transmitter and HFBR-24x6Z 125 MHz receiver pair up to provide a duplex solution optimized for 100 Base-SX. 100Base-SX is a Fast Ethernet Standard (100 Mbps) at 850 nm on multimode fiber.

Complete evaluation kits are available for ST product offerings; including transmitter, receiver, connected cable, and technical literature. In addition, ST connected cables are available for evaluation.

Features

- RoHS Compliant
- Meets IEEE 802.3 Ethernet and 802.5 Token Ring Standards
- Meets TIA/EIA-785 100Base-SX standard
- Low Cost Transmitters and Receivers
- Choice of ST®, SMA, SC or FC Ports
- 820 nm Wavelength Technology
- Signal Rates up to 160 MBd
- Link Distances up to 2.7 km
- Compatible with 50/125 μm , 62.5/125 μm , 100/140 μm , and 200 μm HCS® Fiber
- Repeatable ST Connections within 0.2 dB Typical
- Unique Optical Port Design for Efficient Coupling
- Auto-Insertable and Wave Solderable
- No Board Mounting Hardware Required
- Wide Operating Temperature Range -40 °C to +85 °C
- AlGaAs Emitters 100% Burn-In Ensures High Reliability
- Conductive Port Option

Applications

- 100Base-SX Fast Ethernet on 850 nm
- Media/fiber conversion, switches, routers, hubs and NICs on 100Base-SX
- Local Area Networks
- Computer to Peripheral Links
- Computer Monitor Links
- Digital Cross Connect Links
- Central Office Switch/PBX Links
- Video Links
- Modems and Multiplexers
- Suitable for Tempest Systems
- Industrial Control Links

ST® is a registered trademark of AT&T.

HCS® is a registered trademark of the OFS Corporation.

Applications Support Guide

This section gives the designer information necessary to use the HFBR-0400Z series components to make a functional fiber optic transceiver.

Avago Technologies offers a wide selection of evaluation kits for hands-on experience with fiber optic products as well as a wide range of application notes complete with circuit diagrams and board layouts.

Furthermore, Avago Technologies application support group is always ready to assist with any design consideration.

Application Literature

Title	Description
HFBR-0400Z Series Reliability Data	Transmitter & Receiver Reliability Data
Application Bulletin 78	Low Cost Fiber Optic Links for Digital Applications up to 155 MBd
Application Note 1038	Complete Fiber Solutions for IEEE 802.3 FOIRL, 10Base-FB and 10Base-FL
Application Note 1065	Complete Solutions for IEEE 802.5J Fiberoptic Token Ring
Application Note 1073	HFBR-0219 Test Fixture for 1x9 Fiber Optic Transceivers
Application Note 1086	Optical Fiber Interconnections in Telecommunication Products
Application Note 1121	DC to 32 MBd Fiberoptic Solutions
Application Note 1122	2 to 70 MBd Fiberoptic Solutions
Application Note 1123	20 to 160 MBd Fiberoptic Solutions
Application Note 1137	Generic Printed Circuit Layout Rules
Application Note 1383	Cost Effective Fiber and Media Conversion for 100Base-SX

勝特力材料 886-3-5753170
勝特力电子(上海) 86-21-34970699
勝特力电子(深圳) 86-755-83298787
[Http://www.100y.com.tw](http://www.100y.com.tw)

HFBR-0400Z Series Evaluation Kits

HFBR-0410Z ST Evaluation Kit

Contains the following:

- One HFBR-1412Z transmitter
- One HFBR-2412Z five megabaud TTL receiver
- Three meters of ST connected 62.5/125 μm fiber optic cable with low cost plastic ferrules.
- Related literature

HFBR-0414Z ST Evaluation Kit

Includes additional components to interface to the transmitter and receiver as well as the PCB to reduce design time. Contains the following:

- One HFBR-1414TZ transmitter
- One HFBR-2416TZ receiver
- Three meters of ST connected 62.5/125 μm fiber optic cable
- Printed circuit board
- ML-4622 CP Data Quantizer
- 74ACT1000N LED Driver
- LT1016CN8 Comparator
- 4.7 μH Inductor
- Related literature

HFBR-0400Z SMA Evaluation Kit

Contains the following:

- One HFBR-1402Z transmitter
- One HFBR-2402Z five megabaud TTL receiver
- Two meters of SMA connected 1000 μm plastic optical fiber
- Related literature

HFBR-0416Z Evaluation Kit

Contains the following:

- One fully assembled 1x9 transceiver board for 155 MBd evaluation including:
 - HFBR-1414Z transmitter
 - HFBR-2416Z receiver
 - circuitry
- Related literature

Package and Handling Information

Package Information

All HFBR-0400Z Series transmitters and receivers are housed in a low-cost, dual-inline package that is made of high strength, heat resistant, chemically resistant, and UL 94V-O flame retardant ULTEM[®] plastic (UL File #E121562). The transmitters are easily identified by the light grey color connector port. The receivers are easily identified by the dark grey color connector port. (Black color for conductive port). The package is designed for auto-insertion and wave soldering so it is ideal for high volume production applications.

Handling and Design Information

Each part comes with a protective port cap or plug covering the optics. These caps/plugs will vary by port style. When soldering, it is advisable to leave the protective cap on the unit to keep the optics clean. Good system performance requires clean port optics and cable ferrules to avoid obstructing the optical path.

Clean compressed air often is sufficient to remove particles of dirt; methanol on a cotton swab also works well.

Recommended Chemicals for Cleaning/Degreasing HFBR-0400Z Products

Alcohols: methyl, isopropyl, isobutyl.

Aliphatics: hexane, heptane, Other: soap solution, naphtha.

Do not use partially halogenated hydrocarbons such as 1,1,1 trichloroethane, ketones such as MEK, acetone, chloroform, ethyl acetate, methylene dichloride, phenol, methylene chloride, or N-methylpyrrolidone. Also, Avago Technologies does not recommend the use of cleaners that use halogenated hydrocarbons because of their potential environmental harm.

勝特力材料 886-3-5753170
勝特力电子(上海) 86-21-34970699
勝特力电子(深圳) 86-755-83298787
[Http://www.100y.com.tw](http://www.100y.com.tw)

Mechanical Dimensions - SMA Port

HFBR-x40xZ

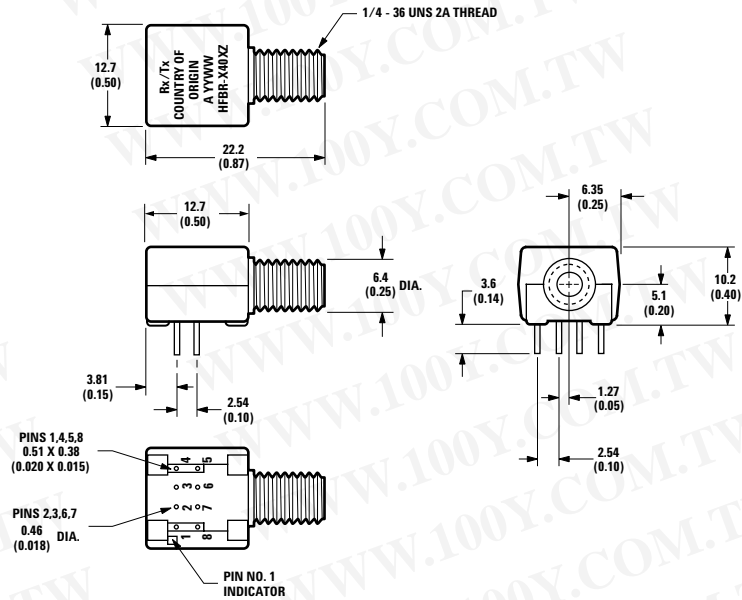

勝特力材料 886-3-5753170
勝特力电子(上海) 86-21-34970699
勝特力电子(深圳) 86-755-83298787
[Http://www.100y.com.tw](http://www.100y.com.tw)

Mechanical Dimensions - ST Port

HFBR-x41xZ

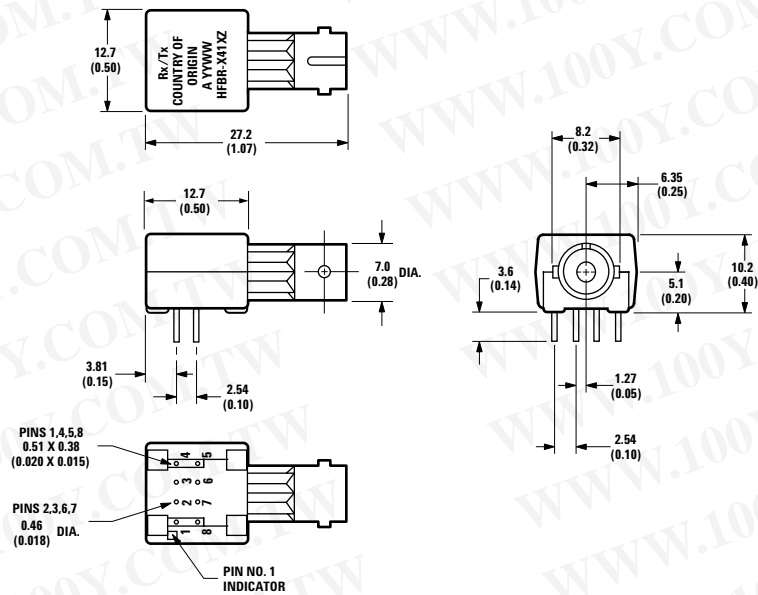

Mechanical Dimensions - Threaded ST Port

HFBR-x41xTZ

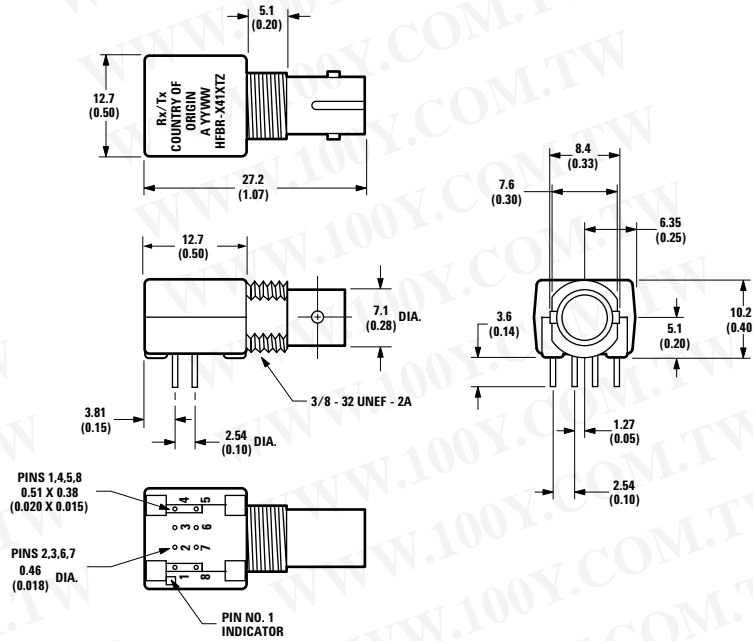

Mechanical Dimensions - FC Port

HFBR-x42xZ

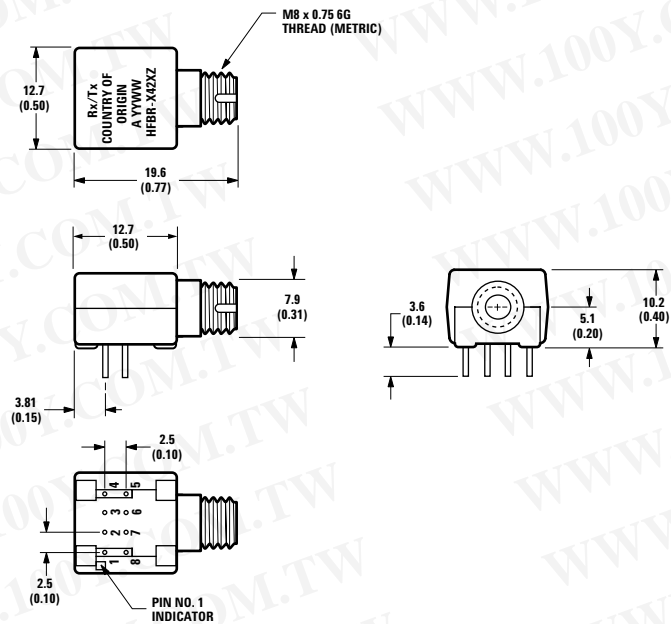

勝特力材料 886-3-5753170
 勝特力电子(上海) 86-21-34970699
 勝特力电子(深圳) 86-755-83298787
[Http://www.100y.com.tw](http://www.100y.com.tw)

Mechanical Dimensions - SC Port

HFBR-x4ExZ

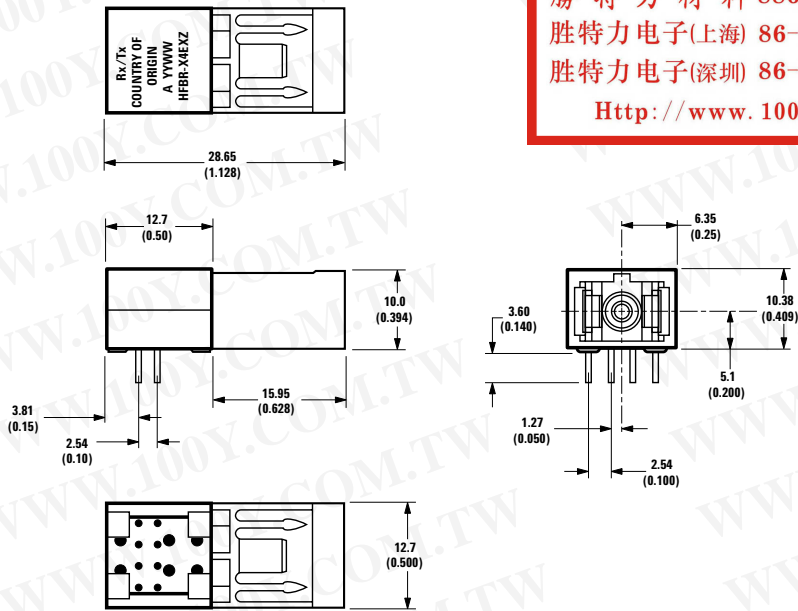
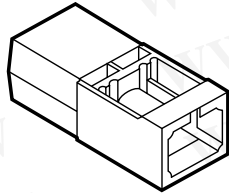

勝特力材料 886-3-5753170
勝特力电子(上海) 86-21-34970699
勝特力电子(深圳) 86-755-83298787
[Http://www.100y.com.tw](http://www.100y.com.tw)

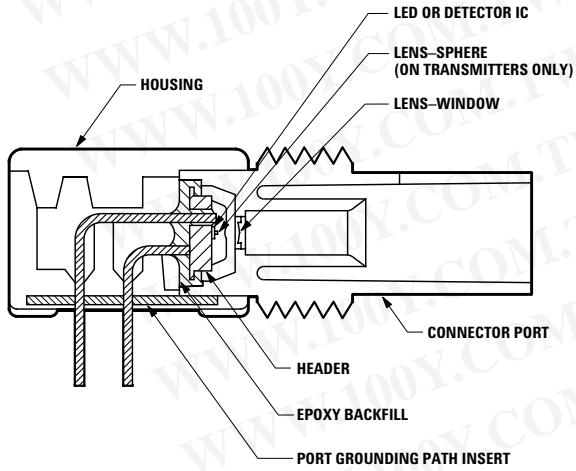

勝特力材料 886-3-5753170
 勝特力电子(上海) 86-21-34970699
 勝特力电子(深圳) 86-755-83298787
[Http://www.100y.com.tw](http://www.100y.com.tw)

Figure 1. HFBR-0400Z ST Series Cross-Sectional View.

Panel Mount Hardware

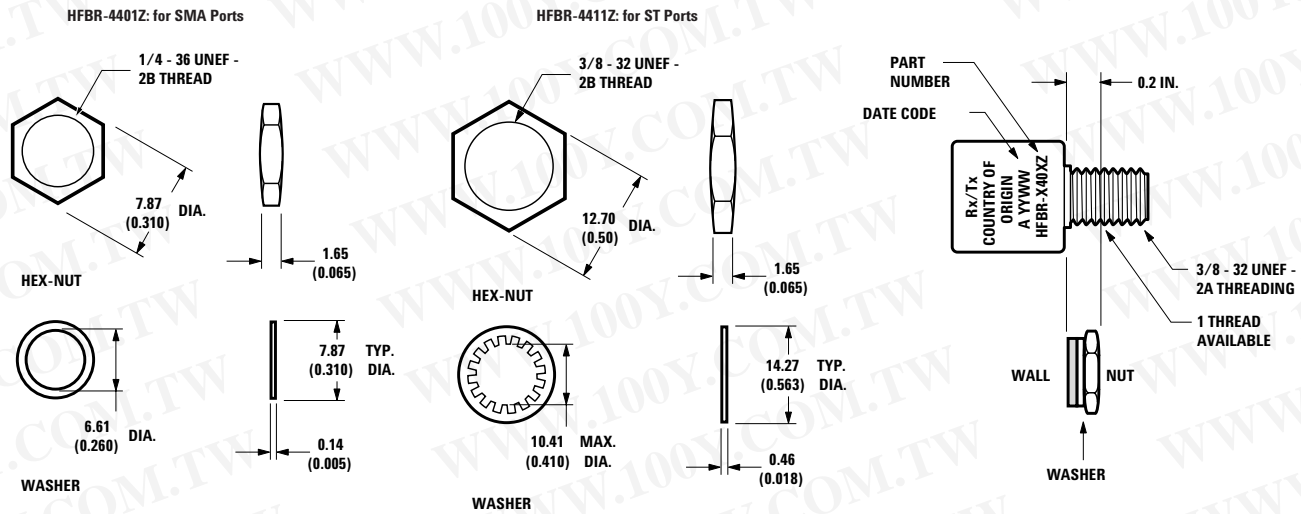

(Each HFBR-4401Z and HFBR-4411Z kit consists of 100 nuts and 100 washers).

Port Cap Hardware

HFBR-4402Z: 500 SMA Port Caps
 HFBR-4120Z: 500 ST Port Plugs (120 psi)

Options

In addition to the various port styles available for the HFBR-0400Z series products, there are also several extra options that can be ordered. To order an option, simply place the corresponding option number at the end of the part number. See page 2 for available options.

Option T (Threaded Port Option)

- Allows ST style port components to be panel mounted.
- Compatible with all current makes of ST® multimode connectors
- Mechanical dimensions are compliant with MIL-STD-83522/13
- Maximum wall thickness when using nuts and washers from the HFBR-4411Z hardware kit is 2.8 mm (0.11 inch)
- Available on all ST ports

Option C (Conductive Port Receiver Option)

- Designed to withstand electrostatic discharge (ESD) of 25 kV to the port
- Significantly reduces effect of electromagnetic interference (EMI) on receiver sensitivity
- Allows designer to separate the signal and conductive port grounds
- Recommended for use in noisy environments
- Available on SMA and threaded ST port style receivers only

Option M (Metal Port Option)

- Nickel plated aluminum connector receptacle
- Designed to withstand electrostatic discharge (ESD) of 15 kV to the port
- Significantly reduces effect of electromagnetic interference (EMI) on receiver sensitivity
- Allows designer to separate the signal and metal port grounds
- Recommended for use in very noisy environments
- Available on SMA, ST, and threaded ST ports

勝特力材料 886-3-5753170
勝特力电子(上海) 86-21-34970699
勝特力电子(深圳) 86-755-83298787
[Http://www.100y.com.tw](http://www.100y.com.tw)

Typical Link Data

HFBR-0400Z Series

Description

The following technical data is taken from 4 popular links using the HFBR-0400Z series: the 5 MBd link, Ethernet 20 MBd link, Token Ring 32 MBd link, and the corresponds to transceiver solutions combining the HFBR-0400Z series components and various recommended transceiver design circuits using off-the-shelf electrical components. This data is meant to be regarded as an example of typical link performance for a given design and does not call out any link limitations. Please refer to the appropriate application note given for each link to obtain more information.

5 MBd Link (HFBR-14xxZ/24x2Z)

Link Performance -40 °C to +85 °C unless otherwise specified

Parameter	Symbol	Min.	Typ.	Max.	Units	Conditions	Reference
Optical Power Budget with 50/125 μm fiber	OPB ₅₀	4.2	9.6		dB	HFBR-14x4Z/24x2Z NA = 0.2	Note 1
Optical Power Budget with 62.5/125 μm fiber	OPB _{62.5}	8.0	15		dB	HFBR-14x4Z/24x2Z NA = 0.27	Note 1
Optical Power Budget with 100/140 μm fiber	OPB ₁₀₀	8.0	15		dB	HFBR-14x2Z/24x2Z NA = 0.30	Note 1
Optical Power Budget with 200 μm fiber	OPB ₂₀₀	12	20		dB	HFBR-14x2Z/24x2Z NA = 0.37	Note 1
Date Rate Synchronous		dc		5	MBd		Note 2
Asynchronous		dc		2.5	MBd		Note 3, Fig 7
Propagation Delay LOW to HIGH	t _{PLH}		72		ns	T _A = +25 °C P _R = -21 dBm peak	Figs 6, 7, 8
Propagation Delay HIGH to LOW	t _{PHL}		46		ns		
System Pulse Width Distortion	t _{PLH} - t _{PHL}		26		ns	Fiber cable length = 1 m	
Bit Error Rate	BER			10 ⁻⁹		Data rate <5 Bd P _R > -24 dBm peak	

Notes:

1. OPB at T_A = -40 to +85 °C, V_{CC} = 5.0 V dc, I_{F ON} = 60 mA. P_R = -24 dBm peak.
2. Synchronous data rate limit is based on these assumptions: a) 50% duty factor modulation, e.g., Manchester I or BiPhase Manchester II; b) continuous data; c) PLL Phase Lock Loop demodulation; d) TTL threshold.
3. Asynchronous data rate limit is based on these assumptions: a) NRZ data; b) arbitrary timing-no duty factor restriction; c) TTL threshold.

勝特力材料 886-3-5753170
勝特力电子(上海) 86-21-34970699
勝特力电子(深圳) 86-755-83298787
[Http://www.100y.com.tw](http://www.100y.com.tw)

5 MBd Logic Link Design

If resistor R1 in Figure 2 is 70.4 Ω, a forward current I_F of 48 mA is applied to the HFBR-14x4Z LED transmitter. With I_F = 48 mA the HFBR-14x4Z/24x2Z logic link is guaranteed to work with 62.5/125 μm fiber optic cable over the entire range of 0 to 1750 meters at a data rate of dc to 5 MBd, with arbitrary data format and pulse width distortion typically less than 25%. By setting R₁ = 115 Ω, the transmitter can be driven with I_F = 30 mA, if it is desired to economize on power or achieve lower pulse distortion.

The following example will illustrate the technique for selecting the appropriate value of I_F and R₁.

$$R_1 = \frac{V_{CC} - V_F}{I_F} = \frac{5V - 1.5V}{15 \text{ mA}}$$

$$R_1 = 233 \Omega$$

Maximum distance required = 400 meters. From Figure 3 the drive current should be 15 mA. From the transmitter data V_F = 1.5 V (max.) at I_F = 15 mA as shown in Figure 9.

The curves in Figures 3, 4, and 5 are constructed assuming no inline splice or any additional system loss. Should the link consist of any in-line splices, these curves can still be used to calculate link limits provided they are shifted by the additional system loss expressed in dB. For example, Figure 3 indicates that with 48 mA of transmitter drive current, a 1.75 km link distance is achievable with 62.5/125 μm fiber which has a maximum attenuation of 4 dB/km. With 2 dB of additional system loss, a 1.25 km link distance is still achievable.

勝特力材料 886-3-5753170
 勝特力电子(上海) 86-21-34970699
 勝特力电子(深圳) 86-755-83298787
[Http://www.100y.com.tw](http://www.100y.com.tw)

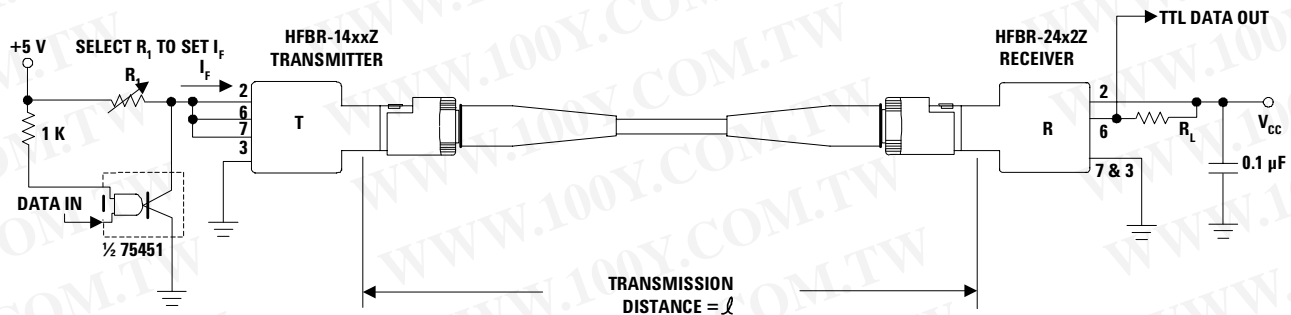

NOTE:
 IT IS ESSENTIAL THAT A BYPASS CAPACITOR (0.01 μF TO 0.1 μF CERAMIC) BE CONNECTED FROM PIN 2 TO PIN 7 OF THE RECEIVER. TOTAL LEAD LENGTH BETWEEN BOTH ENDS OF THE CAPACITOR AND THE PINS SHOULD NOT EXCEED 20 MM.

Figure 2. Typical Circuit Configuration.

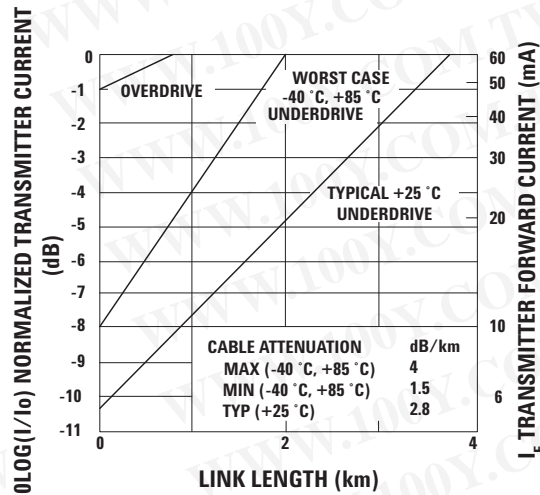

Figure 3. HFBR-1414Z/HFBR-2412Z Link Design Limits with 62.5/125 μm Cable.

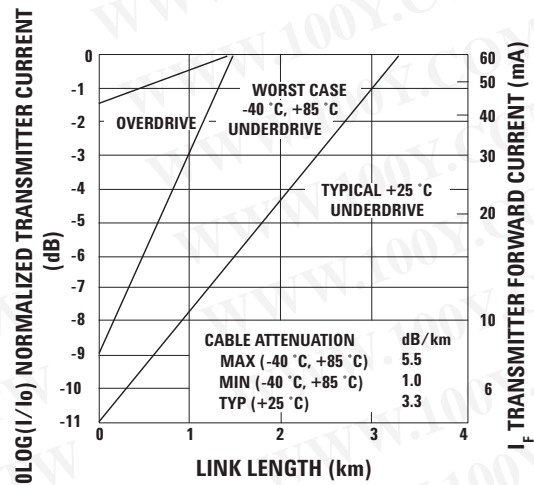

Figure 4. HFBR-14x2Z/HFBR-24x2Z Link Design Limits with 100/140 μm Cable.

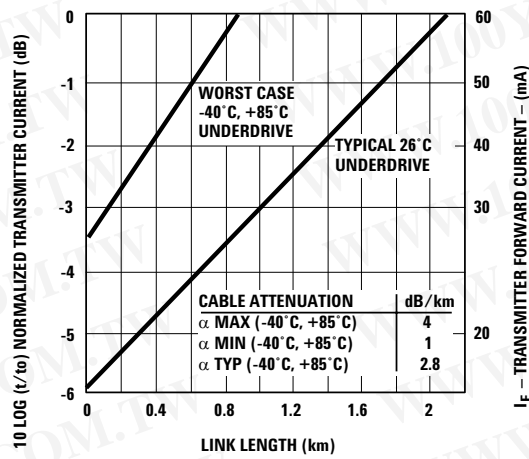

Figure 5. HFBR-14x4Z/HFBR-24x2Z Link Design Limits with 50/125 μm Cable.

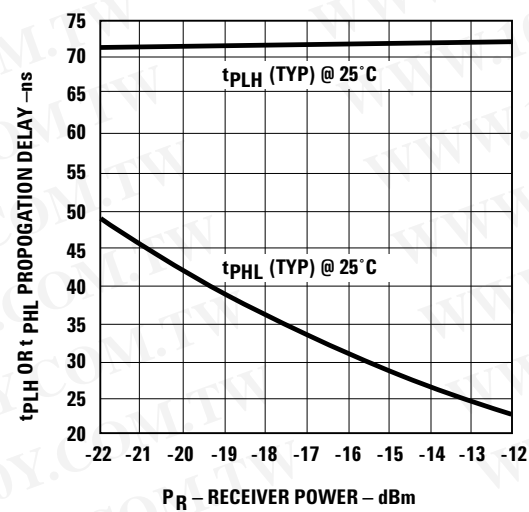

Figure 6. Propagation Delay through System with One Meter of Cable.

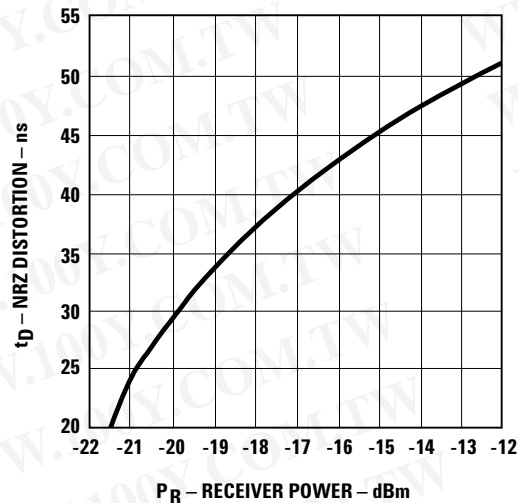

Figure 7. Typical Distortion of Pseudo Random Data at 5 Mb/s.

勝特力材料 886-3-5753170
 勝特力电子(上海) 86-21-34970699
 勝特力电子(深圳) 86-755-83298787
[Http://www.100y.com.tw](http://www.100y.com.tw)

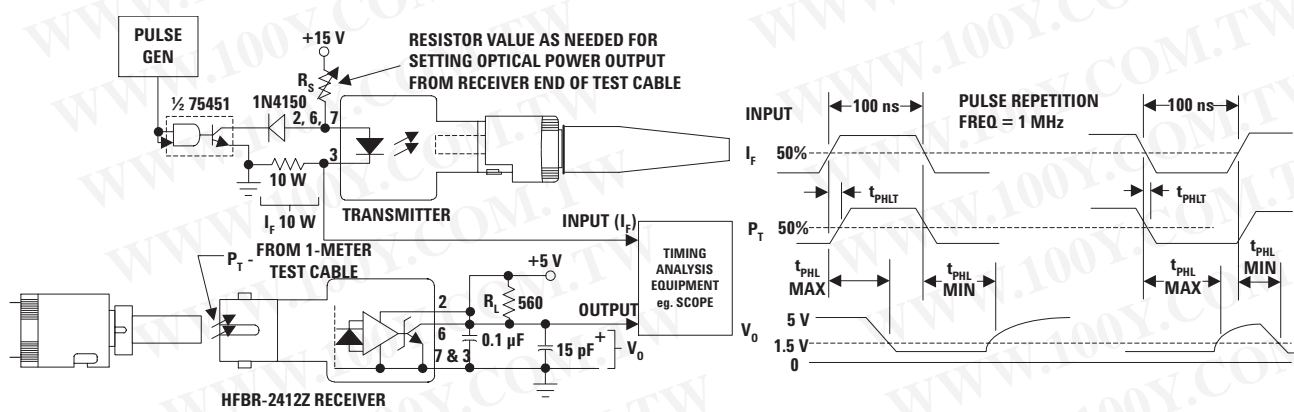

Figure 8. System Propagation Delay Test Circuit and Waveform Timing Definitions.

Ethernet 20 Mbd Link (HFBR-14x4Z/24x6Z)

(refer to Application Note 1038 for details)

Typical Link Performance

Parameter	Symbol	Typ [1, 2]	Units	Conditions
Receiver Sensitivity		-34.4	dBm average	20 MBd D2D2 hexadecimal data 2 km 62.5/125 μ m fiber
Link Jitter		7.56 7.03	ns pk-pk ns pk-pk	ECL Out Receiver TTL Out Receiver
Transmitter Jitter		0.763	ns pk-pk	20 MBd D2D2 hexadecimal data
Optical Power	P_T	-15.2	dBm average	20 MBd D2D2 hexadecimal data- Peak $I_{F,ON} = 60$ mA
LED Rise Time	t_r	1.30	ns	1 MHz square wave input
LED Fall Time	t_f	3.08	ns	
Mean Difference	$ t_r - t_f $	1.77	ns	
Bit Error Rate	BER	10^{-10}		
Output Eye Opening		36.7	ns	At AUI receiver output
Data Format 50% Duty Factor		20	MBd	

Notes:

1. Typical data at $T_A = +25$ °C, $V_{CC} = 5.0$ V dc.
2. Typical performance of circuits shown in Figure 1 and Figure 3 of AN-1038 (see applications support section).

勝特力材料 886-3-5753170
 勝特力电子(上海) 86-21-34970699
 勝特力电子(深圳) 86-755-83298787
[Http://www.100y.com.tw](http://www.100y.com.tw)

Token Ring 32 MBd Link (HFBR-14x4Z/24x6Z)
(refer to Application Note 1065 for details)

勝特力材料 886-3-5753170
 勝特力电子(上海) 86-21-34970699
 勝特力电子(深圳) 86-755-83298787
[Http://www.100y.com.tw](http://www.100y.com.tw)

Typical Link Performance

Parameter	Symbol	Typ [1, 2]	Units	Conditions
Receiver Sensitivity		-34.1	dBm average	32 MBd D2D2 hexadecimal data 2 km 62.5/125 μm fiber
Link Jitter		6.91 5.52	ns pk-pk ns pk-pk	ECL Out Receiver TTL Out Receiver
Transmitter Jitter		0.823	ns pk-pk	32 MBd D2D2 hexadecimal data
Optical Power Logic Level "0"	P _{T ON}	-12.2	dBm peak	Transmitter TTL in I _{F ON} = 60 mA, I _{F OFF} = 1 mA
Optical Power Logic Level "1"	P _{T OFF}	-82.2		
LED Rise Time	t _r	1.3	ns	1 MHz square wave input
LED Fall Time	t _f	3.08	ns	
Mean Difference	t _r - t _f	1.77	ns	
Bit Error Rate	BER	10 ⁻¹⁰		
Data Format 50% Duty Factor		32	MBd	

Notes:

1. Typical data at T_A = +25 °C, V_{CC} = 5.0 V dc.
2. Typical performance of circuits shown in Figure 1 and Figure 3 of AN-1065 (see applications support section)

155 MBd Link (HFBR-14x4Z/24x6Z)
(refer to Application Bulletin 78 for details)

Typical Link Performance

Parameter	Symbol	Min	Typ [1, 2]	Max	Units	Conditions	Ref
Optical Power Budget with 50/125 μm fiber	OPB ₅₀	7.9	13.9		dB	NA = 0.2	Note 2
Optical Power Budget with 62.5/125 μm fiber	OPB ₆₂	11.7	17.7		dB	NA = 0.27	
Optical Power Budget with 100/140 μm fiber	OPB ₁₀₀	11.7	17.7		dB	NA = 0.30	
Optical Power Budget with 200 μm HCS fiber	OPB ₂₀₀	16.0	22.0		dB	NA = 0.35	
Data Format 20% to 80% Duty Factor		1		175	MBd		
System Pulse Width Distortion	t _{PLH} - t _{PHL}		1		ns	PR = -7 dBm peak1 m 62.5/125 μm fiber	
Bit Error Rate	BER		10 ⁻⁹			Data rate < 100 MBaud PR > -31 dBm peak	Note 2

Notes:

1. Typical data at T_A = +25 °C, V_{CC} = 5.0 V dc, PECL serial interface.
2. Typical OPB was determined at a probability of error (BER) of 10⁻⁹. Lower probabilities of error can be achieved with short fibers that have less optical loss.

HFBR-14x2Z/14x4Z Low-Cost High-Speed Transmitters

Description

The HFBR-14xxZ fiber optic transmitter contains an 820 nm AlGaAs emitter capable of efficiently launching optical power into four different optical fiber sizes: 50/125 μm , 62.5/125 μm , 100/140 μm , and 200 μm HCS[®]. This allows the designer flexibility in choosing the fiber size. The HFBR-14xxZ is designed to operate with the Avago Technologies HFBR-24xxZ fiber optic receivers.

The HFBR-14xxZ transmitter's high coupling efficiency allows the emitter to be driven at low current levels resulting in low power consumption and increased reliability of the transmitter. The HFBR-14x4Z high power transmitter is optimized for small size fiber and typically can launch -15.8 dBm optical power at 60 mA into 50/125 μm fiber and -12 dBm into 62.5/125 μm fiber. The HFBR-14x2Z standard transmitter typically can launch -12 dBm of optical power at 60 mA into 100/140 μm fiber cable. It is ideal for large size fiber such as 100/140 μm . The high launched optical power level is useful for systems where star couplers, taps, or inline connectors create large fixed losses.

Consistent coupling efficiency is assured by the double-lens optical system (Figure 1). Power coupled into any of the three fiber types varies less than 5 dB from part to part at a given drive current and temperature. Consistent coupling efficiency reduces receiver dynamic range requirements which allows for longer link lengths.

Housed Product

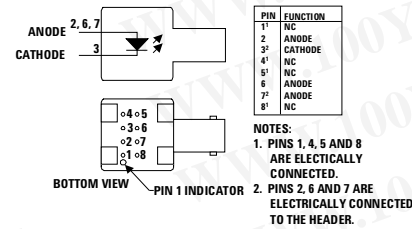

Unhoused Product

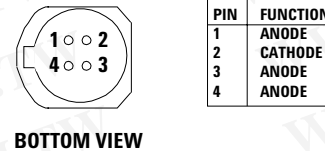

Regulatory Compliance - Targeted Specifications

Feature	Test Method	Performance
Electrostatic Discharge (ESD)	MIL-STD-883 Method 3015	Class 2 (>2KV, <4KV) - Human Body Model

Absolute Maximum Ratings

Parameter	Symbol	Min	Max	Units	Reference
Storage Temperature	T _S	-55	+85	°C	
Operating Temperature	T _A	-40	+85	°C	
Lead Soldering Cycle					
Temp			+260	°C	
Time			10	sec	
Forward Input Current					
Peak	I _{FPK}		200	mA	Note 1
dc	I _{Fdc}		100	mA	
Reverse Input Voltage	VBR		1.8	V	

勝特力材料 886-3-5753170
 勝特力电子(上海) 86-21-34970699
 勝特力电子(深圳) 86-755-83298787
[Http://www.100y.com.tw](http://www.100y.com.tw)

Electrical/Optical Specifications -40 °C to +85 °C unless otherwise specified.

Parameter	Symbol	Min	Typ ²	Max	Units	Conditions	Reference
Forward Voltage	V _F	1.48	1.70 1.84	2.09	V	I _F = 60 mA dc I _F = 100 mA dc	Figure 9
Forward Voltage Temperature Coefficient	ΔV _F /ΔT		-0.22 -0.18		mV/°C	I _F = 60 mA dc I _F = 100 mA dc	Figure 9
Reverse Input Voltage	V _{BR}	1.8	3.8		V	I _F = 100 μA dc	
Peak Emission Wavelength	λ _p	792	820	865	nm		
Diode Capacitance	C _T		55		pF	V = 0, f = 1 MHz	
Optical Power Temperature Coefficient	ΔP _T /ΔT		-0.006 -0.010		dB/°C	I = 60 mA dc I = 100 mA dc	
Thermal Resistance	θ _{JA}		260		°C/W		Notes 3, 8
14x2Z Numerical Aperture	NA		0.49				
14x4Z Numerical Aperture	NA		0.31				
14x2Z Optical Port Diameter	D		290		μm		Note 4
14x4Z Optical Port Diameter	D		150		μm		Note 4

HFBR-14x2Z Output Power Measured Out of 1 Meter of Cable

Parameter	Symbol	Min	Typ	Max	Units	Conditions	Reference
50/125 μm Fiber Cable	P _{T50}	-21.8	-18.8	-16.8	dBm peak	T _A = +25 °C, I _F = 60mA dc	Notes 5, 6, 9
		-22.8		-15.8			
		-20.3	-16.8	-14.4			
		-21.9		-13.8			
62.5/125 μm Fiber Cable	P _{T62}	-19.0	-16.0	-14.0	dBm peak	T _A = +25 °C, I _F = 60mA dc	
		-20.0		-13.0			
		-17.5	-14.0	-11.6			
		-19.1		-11.0			
100/140 μm Fiber Cable	P _{T100}	-15.0	-12.0	-10	dBm peak	T _A = +25 °C, I _F = 60mA dc	
		-16.0		-9.0			
		-13.5	-10.0	-7.6			
		-15.1		-7.0			
200 μm HCS Fiber Cable	P _{T200}	-10.0	-7.0	-5.0	dBm peak	T _A = +25 °C, I _F = 60mA dc	
		-11.0		-4.0			
		-8.5	-5.0	-2.6			
		-10.1		-2.0			

勝特力材料 886-3-5753170
勝特力电子(上海) 86-21-34970699
勝特力电子(深圳) 86-755-83298787
[Http://www.100y.com.tw](http://www.100y.com.tw)

CAUTION: The small junction sizes inherent to the design of these components increase the components' susceptibility to damage from electrostatic discharge (ESD). It is advised that normal static precautions be taken in handling and assembly of these components to prevent damage and/or degradation which may be induced by ESD.

HFBR-14x4Z Output Power Measured out of 1 Meter of Cable

Parameter	Symbol	Min	Typ ²	Max	Units	Conditions	Reference
50/125 μm Fiber Cable NA = 0.2	PT50	-18.8	-15.8	-13.8	dBm peak	T _A = +25 °C, I _F = 60mA dc	Notes 5, 6, 9
		-19.8		-12.8			
		-17.3	-13.8	-11.4		T _A = +25 °C, I _F = 100 mA dc	
		-18.9		-10.8			
62.5/125 μm Fiber Cable NA = 0.275	PT62	-15.0	-12.0	-10.0	dBm peak	T _A = +25 °C, I _F = 60mA dc	
		-16.0		-9.0			
		-13.5	-10.0	-7.6		T _A = +25 °C, I _F = 100 mA dc	
		-15.1		-7.0			
100/140 μm Fiber Cable NA = 0.3	PT100	-11.5	-8.5	-6.5	dBm peak	T _A = +25 °C, I _F = 60mA dc	
		-12.5		-5.5			
		-10.0	-6.5	-4.1		T _A = +25 °C, I _F = 100 mA dc	
		-11.6		-3.5			
200 μm HCS Fiber Cable NA = 0.37	PT200	-7.5	-4.5	-2.5	dBm peak	T _A = +25 °C, I _F = 60mA dc	
		-8.5		-1.5			
		-6.0	-2.5	-0.1		T _A = +25 °C, I _F = 100 mA dc	
		-7.6		0.5			

HFBR-14x5Z Output Power Measured out of 1 Meter of Cable

Parameter	Symbol	Min	Typ	Max	Units	Conditions
200μm Fiber Cable NA = 0.37	PT200	-6.0	-3.6	0.0	dBm peak	T _A = +25°C, I _F = 60mA
		-7.0		1.0	dBm peak	T _A = -40°C to 85°C, I _F = 60mA
62.5/125μm Fiber Cable NA = 0.275	PT62	-12.0	-10.5	-8.0	dBm peak	T _A = +25°C, I _F = 60mA
		-13.0		-7.0	dBm peak	T _A = -40°C to 85°C, I _F = 60mA
50/125μm Fiber Cable NA = 0.2	PT50	-16.5	-14.3	-11.5	dBm peak	T _A = +25°C, I _F = 60mA
		-17.5		-10.5	dBm peak	T _A = -40°C to 85°C, I _F = 60mA

14x2Z/14x4Z/14x5Z Dynamic Characteristics

Parameter	Symbol	Min	Typ ²	Max	Units	Conditions	Reference
Rise Time, Fall Time (10% to 90%)	t _r , t _f		4.0	6.5	nsec	I _F = 60 mA	Note 7
						No pre-bias	
Rise Time, Fall Time (10% to 90%)	t _r , t _f		3.0		nsec	I _F = 10 to 100 mA	Note 7, Figure 11
Pulse Width Distortion	PWD		0.5		nsec		Figure 11

Notes:

- For I_{FPK} > 100 mA, the time duration should not exceed 2 ns.
- Typical data at T_A = +25 °C.
- Thermal resistance is measured with the transmitter coupled to a connector assembly and mounted on a printed circuit board.
- D is measured at the plane of the fiber face and defines a diameter where the optical power density is within 10 dB of the maximum.
- P_T is measured with a large area detector at the end of 1 meter of mode stripped cable, with an ST® precision ceramic ferrule (MILSTD-83522/13) for HFBR-1412Z/1414Z, and with an SMA 905 precision ceramic ferrule for HFBR-1402Z/1404Z.
- When changing mW to dBm, the optical power is referenced to 1 mW (1000 mW). Optical Power P (dBm) = 10 log P (mW)/1000 mW.
- Pre-bias is recommended if signal rate > 10 MBd, see recommended drive circuit in Figure 11.
- Pins 2, 6 and 7 are welded to the anode header connection to minimize the thermal resistance from junction to ambient. To further reduce the thermal resistance, the anode trace should be made as large as is consistent with good RF circuit design.
- Fiber NA is measured at the end of 2 meters of mode stripped fiber, using the far-field pattern. NA is defined as the sine of the half angle, determined at 5% of the peak intensity point. When using other manufacturer's fiber cable, results will vary due to differing NA values and specification methods.

勝特力材料 886-3-5753170
勝特力电子(上海) 86-21-34970699
勝特力电子(深圳) 86-755-83298787
[Http://www.100y.com.tw](http://www.100y.com.tw)

All HFBR-14XXZ LED transmitters are classified as IEC 825-1 Accessible Emission Limit (AEL) Class 1 based upon the current proposed draft scheduled to go in to effect on January 1, 1997. AEL Class 1 LED devices are considered eye safe. Contact your Avago Technologies sales representative for more information.

CAUTION: The small junction sizes inherent to the design of these components increase the components' susceptibility to damage from electrostatic discharge (ESD). It is advised that normal static precautions be taken in handling and assembly of these components to prevent damage and/or degradation which may be induced by ESD.

Recommended Drive Circuits

The circuit used to supply current to the LED transmitter can significantly influence the optical switching characteristics of the LED. The optical rise/fall times and propagation delays can be improved by using the appropriate circuit techniques. The LED drive circuit shown in Figure 11 uses frequency compensation to reduce the typical rise/fall times of the LED and a small pre-bias voltage to minimize propagation delay differences that cause pulse-width distortion. The circuit will typically produce rise/fall times of 3 ns, and a total jitter including pulse-width dis-

tortion of less than 1 ns. This circuit is recommended for applications requiring low edge jitter or high-speed data transmission at signal rates of up to 155 MBd. Component values for this circuit can be calculated for different LED drive currents using the equations shown below. For additional details about LED drive circuits, the reader is encouraged to read Avago Technologies Application Bulletin 78 and Application Note 1038.

$$R_Y = \frac{(V_{CC} - V_F) + 3.97(V_{CC} - V_F - 1.6V)}{I_{F\ ON} (A)}$$

$$R_{X1} = \frac{1}{2} \left(\frac{R_Y}{3.97} \right)$$

$$R_{EQ2} (\Omega) = R_{X1} - 1$$

$$R_{X2} = R_{X3} = R_{X4} = 3(R_{EQ2})$$

$$C(pF) = \frac{2000\ ps}{R_{X1}(\Omega)}$$

Example for $I_{F\ ON} = 100mA$:
 V_F can be obtained from Figure 9 (= 1.84 V).

$$R_Y = \frac{(5 - 1.84) + 3.97(5 - 1.84 - 1.6)}{0.100}$$

$$R_Y = \frac{3.16 + 6.19}{0.100} = 93.5\ \Omega$$

$$R_{X1} = \frac{1}{2} \left(\frac{93.5}{3.97} \right) = 11.8\ \Omega$$

$$R_{EQ2} = 11.8 - 1 = 10.8\ \Omega$$

$$R_{X2} = R_{X3} = R_{X4} = 3(10.8) = 32.4\ \Omega$$

$$C = \frac{2000\ ps}{11.8\ \Omega} = 169\ pF$$

勝特力材料 886-3-5753170
 勝特力电子(上海) 86-21-34970699
 勝特力电子(深圳) 86-755-83298787
[Http://www.100y.com.tw](http://www.100y.com.tw)

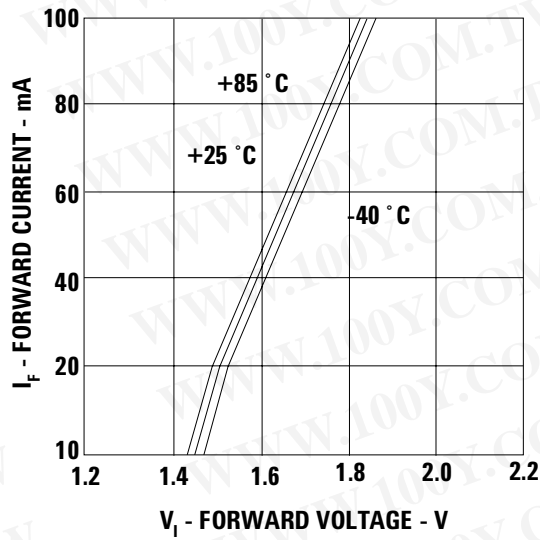

Figure 9. Forward Voltage and Current Characteristics.

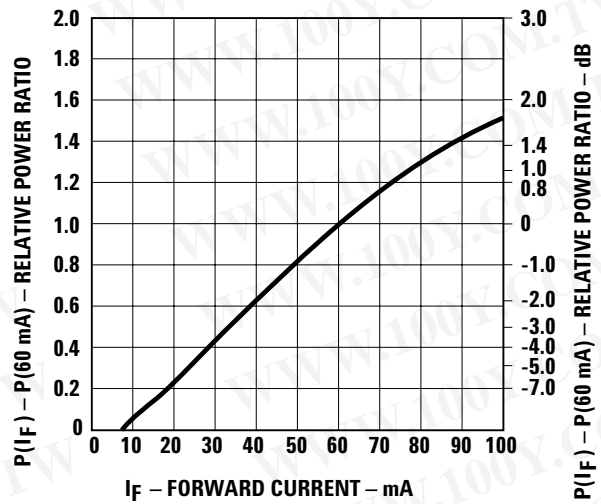

Figure 10. Normalized Transmitter Output vs. Forward Current.

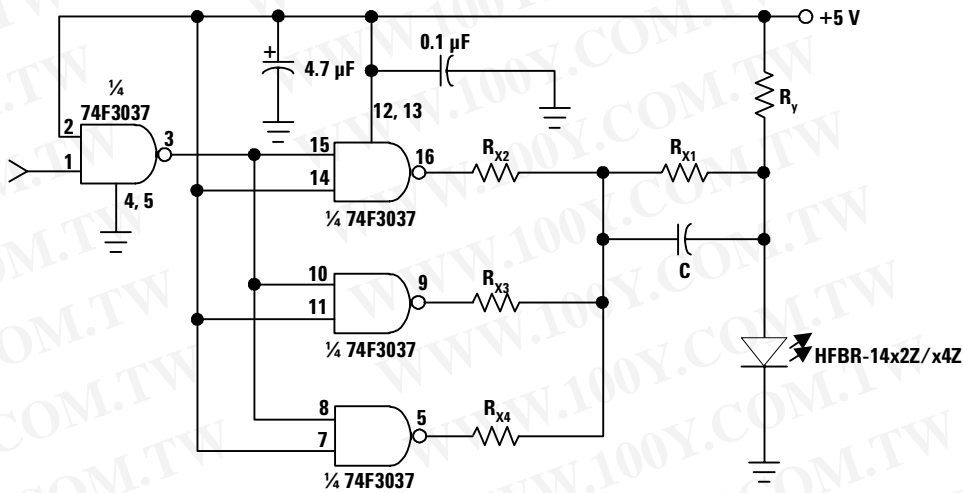

Figure 11. Recommended Drive Circuit.

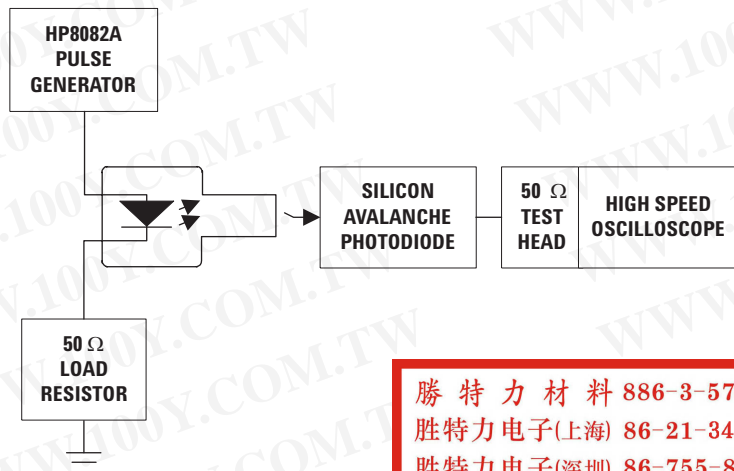

Figure 12. Test Circuit for Measuring t_r , t_f .

勝特力材料 886-3-5753170
 勝特力电子(上海) 86-21-34970699
 勝特力电子(深圳) 86-755-83298787
[Http://www.100y.com.tw](http://www.100y.com.tw)

HFBR-24x2Z Low-Cost 5 MBd Receiver

Description

The HFBR-24x2Z fiber optic receiver is designed to operate with the Avago Technologies HFBR-14xxZ fiber optic transmitter and 50/125 μm , 62.5/125 μm , 100/ 140 μm , and 200 μm HCS® fiber optic cable. Consistent coupling into the receiver is assured by the lensed optical system (Figure 1). Response does not vary with fiber size $\leq 0.100 \mu\text{m}$.

The HFBR-24x2Z receiver incorporates an integrated photo IC containing a photodetector and dc amplifier driving an opencollector Schottky output transistor. The HFBR-24x2Z is designed for direct interfacing to popular logic families. The absence of an internal pull-up resistor allows the open-collector output to be used with logic families such as CMOS requiring voltage excursions much higher than V_{CC} .

Both the open-collector "Data" output Pin 6 and V_{CC} Pin 2 are referenced to "Com" Pin 3, 7. The "Data" output allows busing, strobing and wired "OR" circuit configurations. The transmitter is designed to operate from a single +5 V supply. It is essential that a bypass capacitor (0.1 mF ceramic) be connected from Pin 2 (V_{CC}) to Pin 3 (circuit common) of the receiver.

Housed Product

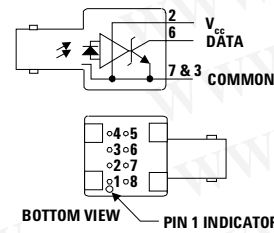

PIN	FUNCTION
1 [†]	NC
2	V_{CC} (5V)
3 [†]	COMMON
4 [†]	NC
5 [†]	NC
6	DATA
7 [†]	COMMON
8 [†]	NC

NOTES:

1. PINS 1, 4, 5 AND 8 ARE ELECTRICALLY CONNECTED
2. PINS 3 AND 7 ARE ELECTRICALLY CONNECTED TO HEADER

Unhoused Product

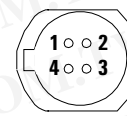

BOTTOM VIEW

PIN	FUNCTION
1	V_{CC} (5V)
2	COMMON
3	DATA
4	COMMON

勝特力材料 886-3-5753170
勝特力电子(上海) 86-21-34970699
勝特力电子(深圳) 86-755-83298787
[Http://www.100y.com.tw](http://www.100y.com.tw)

Absolute Maximum Ratings

Parameter	Symbol	Min	Max	Units	Reference
Storage Temperature	T_S	-55	+85	$^{\circ}\text{C}$	
Operating Temperature	T_A	-40	+85	$^{\circ}\text{C}$	
Lead Soldering Cycle Temp Time			+260 10	$^{\circ}\text{C}$ sec	Note 1
Supply Voltage	V_{CC}	-0.5	7.0	V	
Output Current	I_O		25	mA	
Output Voltage	V_O	-0.5	18.0	V	
Output Collector Power Dissipation	P_{OAV}		40	mW	
Fan Out (TTL)	N		5		Note 2

Electrical/Optical Characteristics -40 °C to +85 °C unless otherwise specified
 Fiber sizes with core diameter $\leq 100 \mu\text{m}$ and $\text{NA} \leq 0.35$, $4.75 \text{ V} \leq V_{\text{CC}} \leq 5.25 \text{ V}$

Parameter	Symbol	Min	Typ ³	Max	Units	Conditions	Reference
High Level Output Current	I_{OH}		5	250	μA	$V_{\text{O}} = 18$ $P_{\text{R}} < -40 \text{ dBm}$	
Low Level Output Voltage	V_{OL}		0.4	0.5	V	$I_{\text{O}} = 8 \text{ m}$ $P_{\text{R}} > -24 \text{ dBm}$	
High Level Supply Current	I_{CCH}		3.5	6.3	mA	$V_{\text{CC}} = 5.25 \text{ V}$ $P_{\text{R}} < -40 \text{ dBm}$	
Low Level Supply Current	I_{CCL}		6.2	10	mA	$V_{\text{CC}} = 5.25 \text{ V}$ $P_{\text{R}} > -24 \text{ dBm}$	
Equivalent NA	NA		0.50				
Optical Port Diameter	D		400		μm		Note 4

Dynamic Characteristics

-40 °C to +85 °C unless otherwise specified; $4.75 \text{ V} \leq V_{\text{CC}} \leq 5.25 \text{ V}$; $\text{BER} \leq 10^{-9}$

Parameter	Symbol	Min	Typ ³	Max	Units	Conditions	Reference
Peak Optical Input Power Logic Level HIGH	P_{RH}			-40 0.1	dBm pk $\mu\text{W pk}$	$\lambda_{\text{P}} = 820 \text{ nm}$	Note 5
Peak Optical Input Power Logic Level LOW	P_{RL}	-25.4 2.9		-9.2 120	dBm pk $\mu\text{W pk}$	$T_{\text{A}} = +25 \text{ }^{\circ}\text{C}$, $I_{\text{OL}} = 8 \text{ mA}$	Note 5
		-24.0 4.0		-10.0 100	dBm pk $\mu\text{W pk}$	$I_{\text{OL}} = 8 \text{ mA}$	
Propagation Delay LOW to HIGH	t_{PLHR}		65		ns	$T_{\text{A}} = +25 \text{ }^{\circ}\text{C}$, $P_{\text{R}} = -21 \text{ dBm}$, Data Rate =5 MBd	Note 6
Propagation Delay HIGH to LOW	t_{PHLR}		49		ns		

Notes:

- 2.0 mm from where leads enter case.
- 8 mA load ($5 \times 1.6 \text{ mA}$), $R_{\text{L}} = 560 \Omega$.
- Typical data at $T_{\text{A}} = +25 \text{ }^{\circ}\text{C}$, $V_{\text{CC}} = 5.0 \text{ Vdc}$.
- D is the effective diameter of the detector image on the plane of the fiber face. The numerical value is the product of the actual detector diameter and the lens magnification.
- Measured at the end of 100/140 μm fiber optic cable with large area detector.
- Propagation delay through the system is the result of several sequentially-occurring phenomena. Consequently it is a combination of data-rate-limiting effects and of transmission-time effects. Because of this, the data-rate limit of the system must be described in terms of time differentials between delays imposed on falling and rising edges.
- As the cable length is increased, the propagation delays increase at 5 ns per meter of length. Data rate, as limited by pulse width distortion, is not affected by increasing cable length if the optical power level at the receiver is maintained.

CAUTION: The small junction sizes inherent to the design of these components increase the components' susceptibility to damage from electrostatic discharge (ESD). It is advised that normal static precautions be taken in handling and assembly of these components to prevent damage and/or degradation which may be induced by ESD.

勝特力材料 886-3-5753170
 勝特力电子(上海) 86-21-34970699
 勝特力电子(深圳) 86-755-83298787
[Http://www.100y.com.tw](http://www.100y.com.tw)

HFBR-24x6Z Low-Cost 125 MHz Receiver

Description

The HFBR-24x6Z fiber optic receiver is designed to operate with the Avago Technologies HFBR-14xxZ fiber optic transmitters and 50/125 μm , 62.5/125 μm , 100/140 μm and 200 μm HCS® fiber optic cable. Consistent coupling into the receiver is assured by the lensed optical system (Figure 1). Response does not vary with fiber size for core diameters of 100 μm or less.

The receiver output is an analog signal which allows follow-on circuitry to be optimized for a variety of distance/data rate requirements. Low-cost external components can be used to convert the analog output to logic compatible signal levels for various data formats and data rates up to 175 Mbd. This distance/data rate trade-off results in increased optical power budget at lower data rates which can be used for additional distance or splices.

The HFBR-24x6Z receiver contains a PIN photodiode and low noise transimpedance preamplifier integrated circuit. The HFBR-24x6Z receives an optical signal and converts it to an analog voltage. The output is a buffered

emitter follower. Because the signal amplitude from the HFBR-24x6Z receiver is much larger than from a simple PIN photodiode, it is less susceptible to EMI, especially at high signaling rates. For very noisy environments, the conductive or metal port option is recommended. A receiver dynamic range of 23 dB over temperature is achievable (assuming 10-9 BER).

The frequency response is typically dc to 125 MHz. Although the HFBR-24x6Z is an analog receiver, it is compatible with digital systems. Please refer to Application Bulletin 78 for simple and inexpensive circuits that operate at 155 Mbd or higher.

The recommended ac coupled receiver circuit is shown in Figure 14. It is essential that a 10 ohm resistor be connected between pin 6 and the power supply, and a 0.1 mF ceramic bypass capacitor be connected between the power supply and ground. In addition, pin 6 should be filtered to protect the receiver from noisy host systems. Refer to AN 1038, 1065, or AB 78 for details.

勝特力材料 886-3-5753170
 勝特力电子(上海) 86-21-34970699
 勝特力电子(深圳) 86-755-83298787
[Http://www.100y.com.tw](http://www.100y.com.tw)

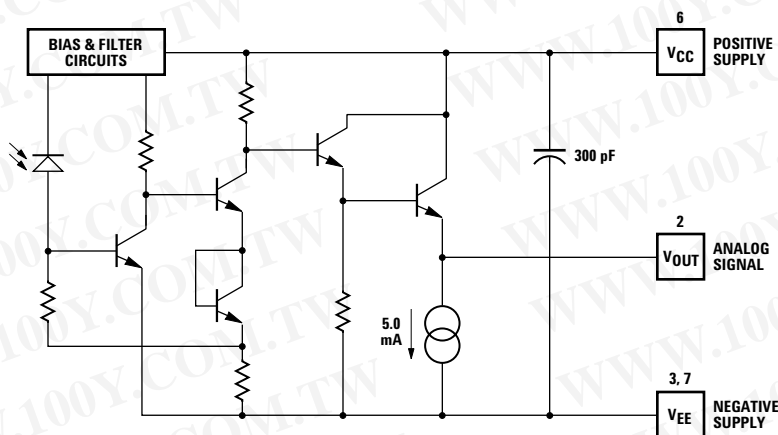
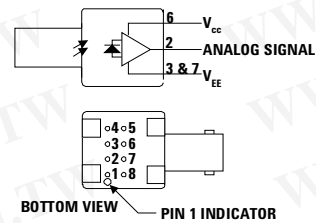

Figure 13. Simplified Schematic Diagram.

Housed Product



PIN	FUNCTION
1*	NC
2	SIGNAL
3*	V_{EE}
4*	NC
5*	NC
6	V_{CC}
7*	V_{EE}
8*	NC

- NOTES:
- PINS 1, 4, 5 AND 8 ARE ISOLATED FROM THE INTERNAL CIRCUITRY, BUT ARE ELECTRICALLY CONNECTED TO EACH OTHER.
 - PINS 3 AND 7 ARE ELECTRICALLY CONNECTED TO HEADER

Unhoused Product

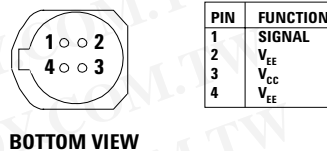

PIN	FUNCTION
1	SIGNAL
2	V_{EE}
3	V_{CC}
4	V_{EE}

CAUTION: The small junction sizes inherent to the design of these components increase the components' susceptibility to damage from electrostatic discharge (ESD). It is advised that normal static precautions be taken in handling and assembly of these components to prevent damage and/or degradation which may be induced by ESD.

Absolute Maximum Ratings

Parameter	Symbol	Min	Max	Units	Reference
Storage Temperature	T _S	-55	+85	°C	
Operating Temperature	T _A	-40	+85	°C	
Lead Soldering Cycle Temp Time			+260 10	°C sec	Note 1
Supply Voltage	V _{CC}	-0.5	6.0	V	
Output Current	I _O		25	mA	
Signal Pin Voltage	V _{SIG}	-0.5	V _{CC}	V	

Electrical/Optical Characteristics -40 °C to +85 °C; 4.75 V ≤ Supply Voltage ≤ 5.25 V,
 R_{LOAD} = 511 Ω, Fiber sizes with core diameter ≤ 100 μm, and N.A. ≤ 0.35 unless otherwise specified.

Parameter	Symbol	Min	Typ ²	Max	Units	Conditions	Reference
Responsivity	R _p	5.3	7	9.6	mV/μW	T _A = +25 °C @ 820 nm, 50 MHz	Note 3, 4 Figure 18
		4.5		11.5	mV/μW		
RMS Output Noise Voltage	V _{NO}		0.40	0.59	mV	Bandwidth filtered @ 75 MHz P _R = 0 μW	Note 5
				0.70	mV	Unfiltered bandwidth P _R = 0 μW	Figure 15
Equivalent Input Optical Noise Power (RMS)	PN		-43.0 0.050	-41.4 0.065	dBm μW	Bandwidth Filtered @ 75MHz	
Optical Input Power (Overdrive)	P _R			-7.6 175	dBm pk μW pk	T _A = +25 °C	Note 6 Figure 16
				-8.2 150	dBm pk μW pk		
Output Impedance	Z _O		30		Ω	Test Frequency = 50 MHz	
dc Output Voltage	V _{O dc}	-4.2	-3.1	-2.4	V	P _R = 0 μW	
Power Supply Current	I _{EE}		9	15	mA	R _{LOAD} = 510 Ω	
Equivalent NA	NA		0.35				
Equivalent Diameter	D		324		μm		Note 7

CAUTION: The small junction sizes inherent to the design of these components increase the components' susceptibility to damage from electrostatic discharge (ESD). It is advised that normal static precautions be taken in handling and assembly of these components to prevent damage and/or degradation which may be induced by ESD.

Dynamic Characteristics

-40 °C to +85 °C; 4.75 V ≤ Supply Voltage ≤ 5.25 V; R_{LOAD} = 511 Ω, C_{LOAD} = 5 pF unless otherwise specified

Parameter	Symbol	Min	Typ ²	Max	Units	Conditions	Reference
Rise/Fall Time 10% to 90%	t _r , t _f		3.3	6.3	ns	P _R = 100 μW peak	Figure 17
Pulse Width Distortion	PWD		0.4	2.5	ns	P _R = 150 μW peak	Note 8, Figure 16
Overshoot			2		%	P _R = 5 μW peak, t _r = 1.5 ns	Note 9
Bandwidth (Electrical)	BW		125		MHz	-3 dB Electrical	
Bandwidth - Rise Time Product			0.41		Hz • s	Note 10	

Notes:

- 2.0 mm from where leads enter case.
- Typical specifications are for operation at T_A = +25 °C and V_{CC} = +5 V dc.
- For 200 μm HCS fibers, typical responsivity will be 6 mV/mW. Other parameters will change as well.
- Pin #2 should be ac coupled to a load ³ 510 ohm. Load capacitance must be less than 5 pF.
- Measured with a 3 pole Bessel filter with a 75 MHz, -3 dB bandwidth. Recommended receiver filters for various bandwidths are provided in Application Bulletin 78.
- Overdrive is defined at PWD = 2.5 ns.
- D is the effective diameter of the detector image on the plane of the fiber face. The numerical value is the product of the actual detector diameter and the lens magnification.
- Measured with a 10 ns pulse width, 50% duty cycle, at the 50% amplitude point of the waveform.
- Percent overshoot is defined as:

$$\left(\frac{V_{PK} - V_{100\%}}{V_{100\%}} \right) \times 100\%$$

- The conversion factor for the rise time to bandwidth is 0.41 since the HFBR-24x6Z has a second order bandwidth limiting characteristic.

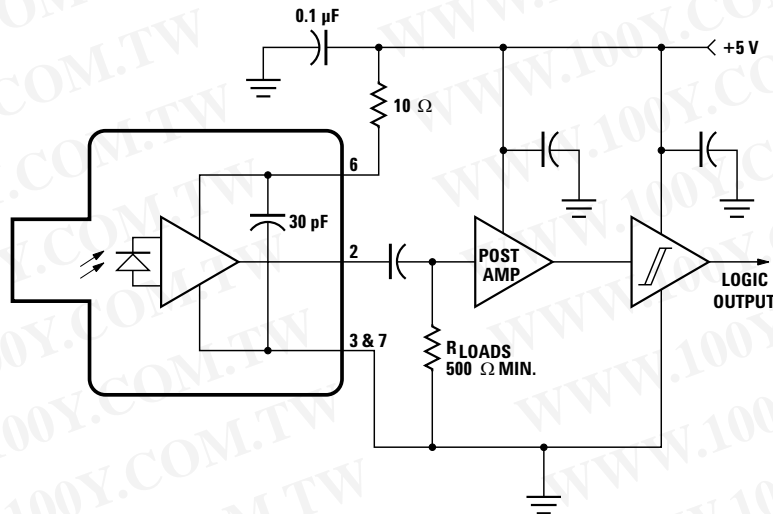

Figure 14. Recommended ac Coupled Receiver Circuit. (See AB 78 and AN 1038 for more information.)

勝特力材料 86-3-5753170
 勝特力电子(上海) 86-21-34970699
 勝特力电子(深圳) 86-755-83298787
[Http://www.100y.com.tw](http://www.100y.com.tw)

CAUTION: The small junction sizes inherent to the design of these components increase the components' susceptibility to damage from electrostatic discharge (ESD). It is advised that normal static precautions be taken in handling and assembly of these components to prevent damage and/or degradation which may be induced by ESD.

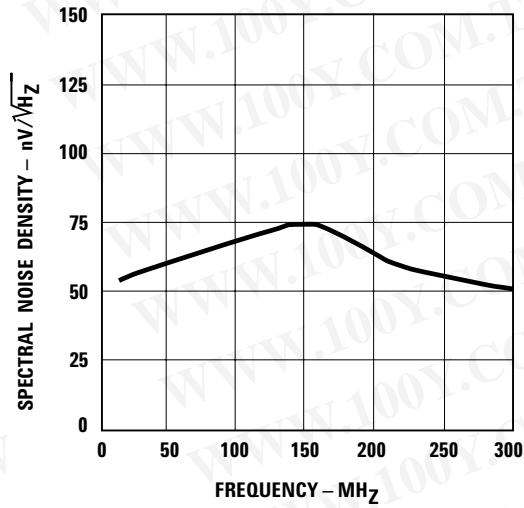

Figure 15. Typical Spectral Noise Density vs. Frequency.

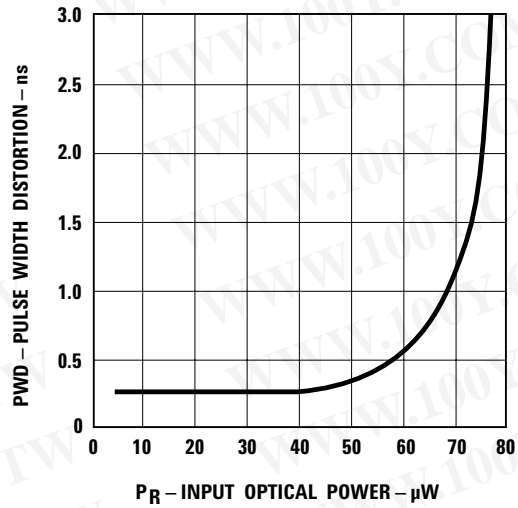

Figure 16. Typical Pulse Width Distortion vs. Peak Input Power.

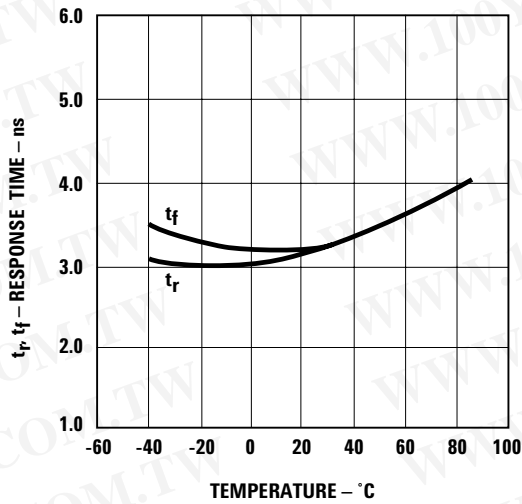

Figure 17. Typical Rise and Fall Times vs. Temperature.

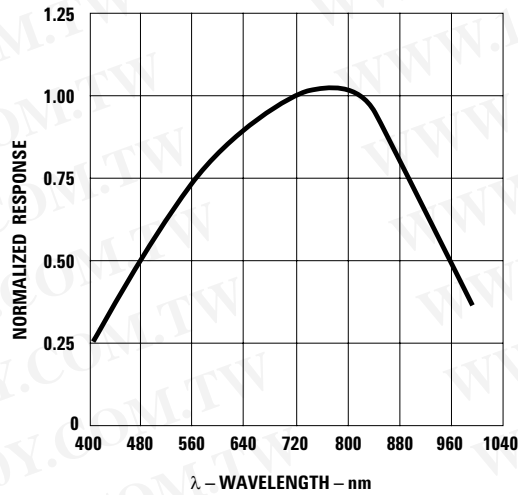

Figure 18. Receiver Spectral Response Normalized to 820 nm.

勝特力材料 886-3-5753170
 勝特力电子(上海) 86-21-34970699
 勝特力电子(深圳) 86-755-83298787
[Http://www.100y.com.tw](http://www.100y.com.tw)

For product information and a complete list of distributors, please go to our web site:

www.avagotech.com

Avago, Avago Technologies, and the A logo are trademarks of Avago Technologies in the United States and other countries. Data subject to change. Copyright © 2005-2009 Avago Technologies. All rights reserved. Obsoletes AV01-0264EN AV02-0176EN - June 12, 2009

AVAGO
 TECHNOLOGIES